

Champion

FASTENERS

Premium quality is 'our' beginning



Assortments and Fasteners

PRODUCT CATALOGUE

EDITION 12



CHAMPION PARTS PTY LTD

INTERSTATE OFFICES AND DISTRIBUTORS

HEAD OFFICE, VICTORIA

205 Arden Street
North Melbourne VIC 3051
Ph: (03) 9325 9000
Ph: (03) 9326 5600
Fax: (03) 9329 2452
Email: sales@championparts.com.au
www.championparts.com.au

NEW SOUTH WALES & A.C.T

BOSS ENTERPRISE

Unit 16/115 Woodpark Road
Smithfield NSW 2164
Ph: (02) 9632 3027
Fax: (02) 9632 2626
Email: sales@championparts.com.au

SOUTH AUSTRALIA & NORTHERN TERRITORY

AITEX SALES

6/53 Stanbel Road
Salisbury Plain SA 5109
Ph: (08) 8285 1500
Fax: (08) 8285 1510
Email: sales@aitexsa.com.au

QUEENSLAND

A.H. KNOWLES AND COMPANY

2/231 Holt Street
Eagle Farm QLD 4009
Ph: (07) 3868 3311
Fax: (07) 3868 1355
Email: sales@championparts.com.au

WESTERN AUSTRALIA

AITEX SALES

Unit 2/12 Colin Jamieson Drive
Welshpool WA 6106
Ph: (08) 9350 6344
Fax: (08) 9350 6399
Email: sales@aitexwa.com.au

TASMANIA

Contact Head Office

NEW ZEALAND DISTRIBUTOR

ISL INDUSTRIAL

40 Crooks Road
East Tamaki Auckland NZ
Ph: (09) 274 7365
Free Fax: 0800. 301. 302
Admin Fax: (09) 274 0786
Email: sales@isl-industrial.co.nz
www.isl-industrial.co.nz

INDONESIA DISTRIBUTOR

PT AsiaRep
Mid Plaza 2 16th Floor
JL.Jend. Sudirman, Kav. 10 - 11
Jakarta 10220 Indonesia
Ph: +62 21 570 0550
Fax: +62 21 570 7603
Email: asiarep@indosat.net.id

SINGAPORE DISTRIBUTOR

AsiaRep Resource Management Pte Ltd
5 Jalan Masjid #01-06
Kembangan Court
Singapore 418924
Ph: (65) 6842 0281
Fax: (65) 6842 0681
Email: riza@asiarepmining.com

Trading Terms	2
Introduction	3-6
ASSORTMENTS	7-80
By Numerical Listing	7-12
By Product Type	13-28
By Alpha Listing	29-36
Poly Box Assortment Numerical Listing	37-41
Poly Box Assortment Illustrations	42-63
Stainless Steel Numerical Listing	64-65
Stainless Steel Poly Box Illustrations	66-69
Master Kit Numerical Listing	70-72
Master Kit Illustrations	73-80
REPLACEMENTS	81-116
For Poly Box & Master Kits	
BULK PACKS AND TRIM CLIPS	117-141
Trim Clips	118-123
Bulk Packs	124-141
STANDARD PACKS	142-152
BRASSWARE	152-155
AIRLINE FITTINGS AND ACCESSORIES	156-163
MERCHANDISERS	164-215
CLAMSHELL BLISTER ASSORTMENTS	212-213
MISCELLANEOUS PRODUCTS	216-221
CHARTS	222-223

PRODUCT CATALOGUE



ABN: 86 004 661 232

HEAD OFFICE, VICTORIA

205 Arden Street, North Melbourne
VIC 3051 Australia

Tel: (03) 9325 9000
Tel: (03) 9326 5600
Fax: (03) 9329 2452

PO Box 22, North Melbourne
VIC 3051 Australia

Email: sales@championparts.com.au
www.championparts.com.au

OUR COMMITMENT TO QUALITY

The Champion Assortment range is the most comprehensive range of its type assembled in Australia. The range has been designed with the specific requirements of the professional automotive and engineering workshop in mind. The result is that you get what you need in the right quantity, and most importantly, at the right price.

The packages are tough, convenient, replenishable and reusable. Each Assortment product type is labelled with the Replacement Pack part number for ease of replenishment. Champion Parts is accredited to AS/NZS ISO 9001 International Quality Standards, and is committed to quality throughout all facets of the Organisation.



Quality
ISO 9001
SAI GLOBAL
QEC1425

TRADING TERMS

Strictly Nett 30 days

Minimum invoice value: \$25.00 (ex. GST)

RETURNS FOR CREDIT

1. Authorisation must be obtained from our Head Office prior to any goods being returned.
2. Goods returned unauthorised cannot be processed.
3. Authorisation will not be considered for products that are less than standard packs, more than 21 days from date of invoice or less than \$50.00 (ex. GST) invoice value.
4. After authorisation has been received we will fax you a numbered return slip which must be attached to the outside of the carton.
5. Goods must be returned to our Head Office, Melbourne.
6. Goods may not be returned to Interstate Agents or their Representatives.
7. Freight must be prepaid by the sender unless we are at fault in which case we will nominate on the authorisation our preferred method of return or disposal.
8. **All returns 'by request' will be subject to a 30% handling and restocking fee.**
9. Replacement Packs and Blister Packs are not returnable for credit.
10. Items of special type, indent or packaging will not be accepted for return.

STANDARD PACKS

• Air-line Packs	3 per outer	• Bulk Packs	(ea)
• Assortment	(ea)	• Panel Packs	3 per outer
• Assortment Blister	3 per outer	• Replacement Packs	5 per outer
• Auto Packs	5 per outer	• Stainless Packs	3 per outer
• Blister Bolts & Nuts Packs	3 per outer	• Thread Inserts	3 per outer
• Blister Handy Packs	5 per outer	• Trade Packs	3 per outer
• Brass Packs	3 per outer	• Vacuum Packs	3 per outer

DELIVERY

Minimum order value for F.I.S capital cities \$300.00 (ex. GST). For other areas, or orders less than \$300.00 (ex. GST), we reserve the right to impose a freight charge. If other methods of transport are required, please supply a current account number for the nominated freight carrier, when placing orders. For Melbourne metropolitan area, a \$10.00 delivery charge will be added to orders less than \$300.00 (ex. GST).

EDI

Champion Parts are pleased to advise that we are fully capable to trade with our customers via EDI. Please contact us for further details.

INTRODUCTION TO THE NEW CHAMPION CATALOGUE

Hints on how to get the most out of using the catalogue every day...

Thank you for choosing Champion Parts quality fasteners. We hope you find our new catalogue informative and that it becomes your first reference for all your fastener requirements.

Champion Parts is pleased to present our range of Kits (reusable boxed assortments), Replacement Packs (for kits), Bulk products, and most importantly our extensive range of fastener Merchandisers which provide exceptional returns to our retail customers.

In order to help you get the most from our catalogue we have updated the format in a number of ways:

1. All Kits have an image to assist in selecting from our extensive product range.
2. Products conform to Australian and International standards with full traceability.
3. We have provided cross referencing throughout the catalogue to make it easier to navigate to the required products.
4. There is a logical sequence throughout: Kits - Replacements Packs - Bulk.
5. Our standard pack bulk section has been simplified for easier selection.
6. Our Merchandiser section provides a complete listing of product supplied on each merchandiser.
7. All Assortments and Kits contain a carefully selected range of complementary components, covering the most commonly used popular products.

The following information will assist those who are new to the Champion quality fastener range.

MASTER KITS



SEE PAGES 70-72

- Premium storage system in reusable metal cases
- High quality products
- Full replacement stock available
- Master Kits are cross referenced to Replacement Packs where available

ASSORTMENTS POLY BOX RED



NON STAINLESS STEEL RANGE SEE PAGES 42-63

- Smaller than Master Kits in a reusable poly box
- Sometimes referred to as a 'Grab Kit'
- The same high quality contents
- Assortments are cross referenced to Replacement Packs where available

ASSORTMENTS POLY BOX BLUE



STAINLESS STEEL RANGE SEE PAGES 66-69

- Smaller than Master Kits in a reusable poly box
- Sometimes referred to as a 'Grab Kit'
- High quality Stainless Steel including marine grade
- Assortments are cross referenced to Replacement Packs where available
- Replacements range available in all cases

REPLACEMENT PACKS



SEE PAGES 81-116

- Replacement Packs are available to refill Master Kits and Assortments
- The same high quality as the original parts
- Cross reference provided on the inside lid of each kit to identify contents and Replacement Pack part numbers

MERCHANDISERS



Free-Standing
Spinner Type
Merchandiser

SEE PAGES 164-215

- Spinners and wall mounts to meet all requirements
- Highest quality products are used throughout the entire Merchandiser range
- Exceptional return for the floor/wall space required
- All items packaged in recyclable and reusable blisters



Wall Mount
Merchandiser

BULK PACKS



SEE PAGES 124-141

- Packaged items in larger, more economical quantities
- Products conform to Australian and International standards with full traceability
- Clamshell and reusable jar packaging

TRIM CLIPS



SEE PAGES 118-123

- Comprehensive range of high quality trim clips suitable for most vehicle makes and models
- Available in packaged and bulk quantities

BULK STANDARD PACKS



SEE PAGES 142-152

- Packaged for supply to customers who require larger quantities of single items
- Products conform to Australian and International standards with full traceability

CLAMSHELL MINI ASSORTMENTS



SEE PAGES 212-213

- Small pack assortments suitable for everyday use
- Quality items throughout the range
- Reusable clamshells
- All items packaged in recyclable materials

AIRLINE FITTINGS



SEE PAGES 156-163

- High quality Ryco 'Australian Made' range
- Extensive range interchangeable with commonly used brands
- Tyre inflator (see page 163)
- Air guns, hoses and accessories

BRASSWARE

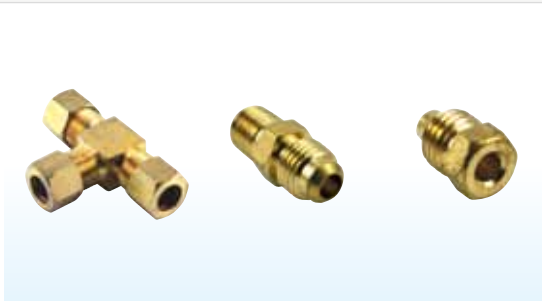

[SEE PAGES 153-155](#)

- High quality
- Brass fittings designed to cover an extensive range of requirements

VACUUM HOSE CONNECTORS & HOSE CLAMPS



[SEE PAGES 135-136](#)

- Extensive range
- Highest quality
- Stainless Steel hose clamps including marine grade 316

PROMOTIONAL ITEMS



[SEE PAGES 219-220](#)

- A range of high quality items in specialised packaging
- Storage cabinets

MISCELLANEOUS ITEMS



[SEE PAGES 216-221](#)

- Tap and die set
- Thread gauges
- Thread tester
- Thread lock
- Thread lube
- Number plate security screws



CHAMPION ASSORTMENTS & MASTER KITS



*Complete Listing of Champion Assortments,
Stainless Steel and Master Kits in Numerical Sequence.*

*All Assortments and Kits contain a carefully
selected range of complementary components, covering the most
commonly used popular products.*

NUMERICAL LISTING

NUMERICAL LISTING ASSORTMENTS

PART NO.	IMAGE PAGE NO.	PRODUCT	MASTER KITS	STAINLESS STEEL
CA21	42	Machine Screws and Nuts – Metric, Pan Head Phillips, Z/P. 12 Sizes: 3 to 6mm x 10 to 25mm Long		
CA22	42	Pipe Support Anchors – Metal with Rubber Protector. 28 Pieces		
CA31	23	Shim Brass – 60mm Wide Rolls. 5 Sizes: .002" to .010" Thickness		
CA32	23	Shim Brass – 150mm x 150mm Sheets. 4 Sizes: .002" to .010" Thickness		
CA33	23	Shim Steel – 60mm Wide Rolls. 4 Sizes: .002" to .010" Thickness		
CA34	23	Shim Steel – 150mm x 150mm Sheets. 4 Sizes: .002" to .010" Thickness		
CA36	23	Stainless Steel Shim – 150mm x 150mm Sheets. 4 Sizes: .003" to .027" Thickness		●
CA38	42	Expansion Plugs – Cup Type Steel, Imperial, Zinc Plated. 13 Sizes: 19/32" to 2-1/16"		
CA42	42	Expansion Plugs – Cup Type Brass, Imperial. 10 Sizes: 3/4" to 2-1/16"		
CA43	42	Expansion Plugs – Cup Type Brass, Metric. 12 Sizes: 20mm to 50mm		
CA52	42	Clevis Pins – Imperial, Zinc Plated. 9 Sizes: 1/4" to 7/16" Dia.		
CA58	43	Drain (Sump) Plugs Steel – Metric and Imperial, Zinc Plated. 9 Sizes		
CA63	43	Wiring Grommets – Rubber. 12 Sizes: 1/8" to 29/32" (Wire Hole Size)		
CA70	43	Brass Fittings – Adaptors, Tails, Elbows, Nuts and Connectors. 20 Types		
CA90	43	Blanking Grommets – Rubber. 8 Sizes: 5/16" to 1-1/8" (Panel Hole Size)		
CA95	43	Brass Manifold Nuts – UNC, UNF, BSF, Metric Fine and Coarse Pitch. 17 Sizes		
CA96	43	Manifold Studs and Nuts – Metric and UNC. Steel Studs and Nuts, Zinc Passivated. 5 Sizes		
CA98	44	Expansion Plugs Steel Disc/Lens Type – Zinc Plated. 16 Sizes: 3/4" to 2"		
CA100	44	Flange Nuts – Zinc Plated. 8 Sizes: 5mm to 12mm, incl. M10 and M12 x 1.25 Fine Pitch		
CA101	44	Extension Springs – 12 Sizes: Lengths 1" to 4-3/4" and 3/16" to 1/2" Dia.		
CA102	44	Compression Springs – 12 Sizes: Lengths 1-1/4" to 4" and 3/16" to 3/4" Dia.		
CA103	44	Accelerator Springs – 9 Sizes: Lengths 4-1/2" to 7" and 3/16" to 7/16" Dia.		
CA105	44	Fuses – Glass, Blade and European. 14 Sizes: 3 Amp. to 35 Amp.		
CA106	45	Wheel Alignment Shims – Imperial. 12 Sizes for GM & Ford Vehicles, 4 Types: 1/32", 1/16" & 1/8" Thick		
CA107	45	Wheel Alignment Shims – Metric. 11 Sizes. Thickness: 1, 1.5, 2 & 3mm. 100 Pieces		
CA108	45	Grease Nipples – Straight and Angle Nipples. UNF, BSF, BSP and NPT Threads. 15 Sizes		
CA109	45	Grease Nipples – Straight and Angle Nipples. Metric, Fine and Coarse. 12 Sizes: 6mm to 10mm Dia.		
CA110	45	Fuses – AF Blade. 8 Sizes: 3, 5, 7.5, 10, 15, 20, 25 & 30 Amp.		
CA111	45	Fuses – Low Profile Blade. 8 Sizes: 3, 5, 7.5, 10, 15, 20, 25 & 30 Amp.		
CA112	46	Fuses – Mini Blade. 8 Sizes: 3, 5, 7.5, 10, 15, 20, 25 & 30 Amp.		
CA113	46	Fuses – AF Circuit Breaker. 7 Sizes: 5, 7.5, 10, 15, 20, 25, 30 Amp.		
CA115	46	Imperial 'O' Rings – Nitrile, 70 Shore. 14 Sizes: 3/16" to 1" I.D.		
CA116	46	Metric 'O' Rings – Nitrile, 70 Shore. 15 Sizes: 5mm to 25mm I.D.		
CA118	46	High Temp and High Pressure 'O' Rings – Viton, Imperial, 75 Shore. 12 Sizes: 7/32" to 1"		
CA120	46	UNF Set Screws with Nuts – High Tensile, GR5, Zinc Plated. 11 Sizes: 1/4" to 3/8" Dia.		
CA124	47	Nylon Cable 'P' Clamps and Cable Tie Mounts – 124 Pieces		
CA125	47	UNC Set Screws and Nuts – High Tensile, GR5, Zinc Plated. 11 Sizes: 1/4" to 3/8" Dia.		
CA126	47	Self-Locking Nuts, Nylon Insert – UNC and UNF, Zinc Plated. 12 Sizes: 3/16" to 1/2"		
CA132	47	Brass Fittings – Olives, Unions, Flare Nuts and Reducing Bushes. 33 Types		
CA134	47	Brass Fittings – Single and Double Unions, Nuts and Elbows. 22 Types		
CA140	47	Drain (Sump) Plug Washers – Fibre, Aluminium and Copper Crush Metric. 12 Sizes: 12 to 25mm I.D.		
CA150	48	Drain (Sump) Plug Washers – Fibre, Metric & Imperial. 10 Sizes: 1/2" to 1" & 18-30mm I.D. – Thickness: 3/32"		
CA155	48	Circlips – Imperial, Internal and External. 14 Sizes: 1/4" to 1"		
CA161	48	Wiring Terminals – Insulated Crimp Type. 14 Types incl. Spade, Ring, Tab and Splice		
CA173	48	Bonded Seal Washers – Imperial. 8 Sizes: 1/8" to 1-1/4" I.D. BSP		
CA174	48	Bonded Seal Washers – Metric. 14 Sizes: Suits 8mm I.D. to 42mm I.D.		
CA177	48	Woodruff Keys – Imperial. 17 Sizes: No.2 to No.'E' (3/32" to 3/8")		

PART NO.	IMAGE PAGE NO.	PRODUCT	MASTER KITS	STAINLESS STEEL
CA178	49	Brass Fittings – Single and Double Unions, Dole Nuts, M/F Elbows, Nipples and Plugs		
CA196	49	Set Screws and Nuts – Metric, High Tensile, GR8.8, Zinc Plated. 13 Sizes: M4 to M10 Dia.		
CA200	49	Flange Head Hex Set Screws and Nuts – Metric J.I.S, H/T, GR8.8, Zinc Plated. 14 Sizes: 5 to 10mm		
CA212	49	High Pressure Series 'O' Rings – Nitrile, Imperial, 90 Shore. 20 Sizes: 3/16" to 2" with Removing Tool		
CA214	215	Stainless Steel Assortment – Screws, Washers and Nuts, 302/A2, 316/A4. 52 Sizes		●
CA225	49	Copper Washers – Imperial. 12 Sizes: 1/4" to 1" I.D. – Thickness: 20G		
CA226	49	Fuel Injection Copper Washers – Metric. 14 Sizes: 6mm to 26mm I.D. – Thickness: 1, 1.5 & 2mm		
CA228	50	Machine Screws and Nuts – Fine Thread Round Head Slotted, Nickel Plated. 11 Sizes: 6/40" to 10/32"		
CA240	50	Wiring Connector Block – M/F with Brass Terminals. 4 Sizes: 2, 4, 6 & 8 Pin		
CA252	50	Machine Screws and Nuts – Mushroom Head Slotted, UNC, Zinc Plated. 8 Sizes: 3/16" to 1/4"		
CA270	50	Self-Locking Nuts, Nylon Insert – Metric, Zinc Plated. 10 Sizes: M5 x 0.8 to M12 x 1.75		
CA276	50	Shim Steel Washers – 22 Sizes: 5/8" to 1-3/8" I.D. – Thickness .006"		
CA280	50	Split Pins – Metric, Zinc Plated. 11 Sizes: 5mm to 13mm Dia. Lengths to 150mm (Large Sizes)		
CA290	51	Machine Screws and Nuts – Round Head Slotted, BSW, Zinc Plated. 8 Sizes: 1/8" x 3/4" to 1/4" x 2"		
CA300	51	Hex Nuts – Metric, Zinc Plated. 12 Sizes: Plain Nuts M3 to M10, Self-Locking Nuts M4 to M10		
CA302	51	Motorcycle Fasteners – Metric Socket Head Cap, Machine & Hex Screws, Nuts & Star Washers, Z/P. 28 Sizes		
CA330	51	Flat Steel Washers – Imperial and Metric, Zinc Plated. 10 Sizes: 3/16" to 3/4" & M10 I.D.		
CA350	51	Self-Tapping Screws – Hex Head, Zinc Plated. 14 Sizes: 6G to 14G – Lengths to 1"		
CA360	51	Self-Locking Nuts, Nylon Insert – Metric, UNC, UNF and Zinc Plated. 10 Sizes: M6 to M10 & 1/4" to 3/8"		
CA365	73	UNF Bolts, Set Screws and Nuts – High Tensile, GR5, Zinc Plated. 16 Sizes: 1/4" to 1/2" Dia.	●	
CA370	73	UNC Bolts, Set Screws and Nuts – High Tensile, GR5, Zinc Plated. 16 Sizes: 1/4" to 1/2" Dia.	●	
CA380	52	Speed Nuts – 'U' and Flat Types, Zinc Passivated. 12 Sizes: 3/32" to 3/16" Dia.		
CA390	52	Fibre Washers – 12 Sizes: 5/32" to 3/4" I.D. – Thickness: 1/16"		
CA400	52	Fibre Washers – 14 Sizes: 1/8" to 1" I.D. – Thickness: 1/32"		
CA407	52	Imperial 'O' Rings – Nitrile, 70 Shore. 32 Sizes: 1/8" to 2" I.D.		
CA408	52	Metric 'O' Rings – Nitrile, 70 Shore. 32 Sizes: 3mm to 50mm I.D.		
CA409	52	'O' Ring Splicing Kit – Nitrile, Imperial, 70 Shore. 5 Sizes: 'O' Ring Cord .070" to .275" (36" each)		
CA410	52	'O' Ring Splicing Kit – Nitrile, Metric, 70 Shore. 9 Sizes: 'O' Ring Cord 1.5mm to 8.5mm (900mm each)		
CA411	53	Air Conditioning 'O' Rings – Suits R134A Gas. HMBR (Green), Imperial, 70 Shore. 10 Sizes: 3/16" to 3/4"		
CA420	53	Self-Tapping Screws – Raised and Pan Head Slotted, Zinc Plated. 12 Sizes: 6G to 12G – Lengths to 1"		
CA430	53	Self-Tapping Screws – Raised, Hex and Pan Head, Zinc Plated. 14 Sizes: 4G to 14G – Lengths to 1-1/2"		
CA431	73	Metric Bolts, Set Screws and Nuts – High Tensile, GR8.8, Zinc Plated. 17 Sizes: M4 to M12 Dia.	●	
CA480	73	Metric Bolts, Set Screws and Nuts – ISO and Fine Pitch, High Tensile, GR8.8, Z/P. 16 Sizes: M4 to M12 Dia.	●	
CA495	73	Flange Head Hex Set Screws and Nuts – Metric, High Tensile, GR8.8, Zinc Plated. 17 Sizes: 5mm to 10mm	●	
CA500	53	Spacing Washers Steel – Imperial. 14 Sizes: 1/4" to 1-1/8" I.D. – Thickness: 22G (.028")		
CA502	53	Rivets Blind Aluminium – 10 Sizes: 3/32" to 3/16" Dia.		
CA505	53	Rivet Nut Inserts – 5 Sizes: 4mm to 10mm Dia.		
CA510	54	Star Washers – Internal and External, Zinc Plated. 14 Sizes: 3/16" to 5/8"		
CA520	54	Spring Washers – Imperial and Metric, Zinc Plated. 11 Sizes: 5/32" to 3/4" & M4 to M16 I.D.		
CA530	54	Self-Drilling Screws – Wafer and Hex Head, Yellow Zinc. 8 Sizes: 8G & 10G – Lengths to 30mm		
CA540	54	Self-Tapping Screws – Pan and Raised Head, Phillips, N/P. 13 Sizes: 4G to 10G – Lengths to 1-1/2"		
CA550	54	Self-Tapping Screws – Pan and Raised Head, Slotted, Zinc Plated. 13 Sizes: 6G to 12G – Lengths to 1"		
CA560	54	Self-Tapping Screws – Pan Head, Slotted, Zinc Plated. 8 Sizes: 6G to 10G – Lengths to 1-1/2"		
CA570	55	Anti-Theft One Way Screws – Self-Tapping and 6mm Thread, incl. Washers and Nuts, Zinc Plated		
CA576	55	Flat Steel Washers – Imperial and Metric, Zinc Plated. 13 Sizes: 3/16" to 3/4" & 6mm to 20mm I.D.		
CA600	55	Flat Steel Heavy Duty Washers – Imperial, Zinc Plated. 8 Sizes: 3/16" to 3/4" I.D. – Thickness: 14G		
CA648	55	Spring Washers – Imperial and Metric, Zinc Plated. 12 Sizes: 5/32" to 5/8" & 4mm to 20mm I.D.		

NUMERICAL LISTING ASSORTMENTS

PART NO.	IMAGE PAGE NO.	PRODUCT	MASTER KITS	STAINLESS STEEL
CA800	55	Split Pins – Imperial, Zinc Plated. 10 Sizes: 1.6mm to 4mm Dia. incl. 7/64" & 9/64" Dia.		
CA825	55	Fibre Washers – 14 Sizes: 1/8" to 1" I.D. – Thickness: 1/32"		
CA1008	56	Spring Washers – Square Section, Zinc Plated, Imperial. 8 Sizes: 3/16" to 3/4" I.D.		
CA1152	56	Split Pins – Zinc Plated. 8 Sizes: 1.6mm to 3.2mm Dia. incl. 7/64" Dia.		
CA1200	56	Self-Tapping Screws – Pan and Raised Head, Phillips, Black Zinc. 14 Sizes: 6G to 12G – Lengths to 1-1/2"		
CA1320	56	Linkages (Ball Joints) – 90° and Inline, Zinc Plated. 10 Sizes: 3/16" to 5/16"		
CA1411	56	Expansion Plugs – Cup Type Steel, Zinc Plated, Metric. 12 Sizes: 18mm to 46.5mm		
CA1412	56	Brass Olives – Suits Copper and Nylon Tube. Sizes: Copper 1/8" to 1/2" & Nylon 3/16" to 3/8", 330 Pieces		
CA1416	57	Socket Set (Grub) Screws – Metric GR8.8 and Imperial, 14 Sizes: 5mm to 8mm & 3/16" to 3/8" BSW		
CA1417	57	Socket Head Cap Screws – Metric, High Tensile, GR8.8, 14 Sizes: M5 to M10 Dia.		
CA1418	57	Socket Head Cap Screws – BSW, High Tensile, 14 Sizes: 3/16" to 5/16" Dia. – Lengths to 1-1/2"		
CA1419	57	Socket Head Cap Screws Countersunk – Metric, GR8.8, Sizes: 4mm to 8mm Dia. – Lengths to 30mm		
CA1420	57	Button Head Cap Screws – Metric, High Tensile. 14 Sizes: 4mm to 8mm Dia. – Lengths to 30mm		
CA1421	57	Roll Pins – Imperial. 18 Sizes: 1/16" to 1/4" Dia. (Small Sizes)		
CA1424	58	'E' Clips and Retainer Springs – 14 Sizes: 3/32" to 5/8"		
CA1435	58	Roll Pins – Imperial. 12 Sizes: 3/16" to 3/8" Dia. (Large Sizes)		
CA1460	58	Polypropylene Washers – 10 Sizes: 18mm to 30mm & 1/2" to 1" I.D. – Thickness: 3mm		
CA1480	58	Hex Set Screws and Nuts – Metric GR8.8, ISO and Fine Pitch, Zinc Plated. 9 Sizes: M6 to M12 Dia.		
CA1630	73	Self-Tapping Screws – Phillips Raised, Pan Slot & Hex Head, incl. Cup Washers. Z/P, N/P. 19 Sizes: 6G to 14G	●	
CA1660	58	Copper Washers – Metric. 10 Sizes: 5mm to 24mm I.D. – Thickness: 1mm		
CA1670	58	Flat Washers, Extra Heavy Duty – Imperial, Zinc Plated. 8 Sizes: 3/16" to 3/4" I.D. – Thickness: up to 9G		
CA1680	59	Polypropylene Washers – Imperial. 16 Sizes: 1/8" to 1" I.D. – Thickness: 1/32"		
CA1690	59	Taper Pins – 14 Sizes: No.0 x 1" to No.5 x 2" (Small Sizes)		
CA1700	59	Taper Pins – 14 Sizes: No.4 x 2-1/2" to No.10 x 6" (Large Sizes)		
CA1705	59	Woodruff Keys – Metric. 17 Sizes: 2mm x 10mm to 10mm x 32mm		
CA1710	59	Self-Tapping Screws – Pan Head Phillips, Zinc Plated. 14 Sizes: 6G to 12G – Lengths to 2"		
CA1715	59	Roll Pins – Metric. 18 Sizes: 2mm to 6mm Dia. (Small Sizes)		
CA1720	60	Self-Tapping Screws – Mushroom Head, Black Zinc. 14 Sizes: 6G to 12G – Lengths to 2"		
CA1725	60	Roll Pins – Metric. 12 Sizes: 5mm to 10mm Dia. (Large Sizes)		
CA1730	60	Panel (Body) Washers – Panel (Body) Steel and Stainless Steel, Zinc Plated. 8 Sizes: 3/16" to 1/2" I.D.		
CA1735	60	Plastic Trim Clips and Screw Grommets – 14 Sizes, 180 Pieces		
CA1740	60	Nylon Washers – Metric and Imperial. 11 Sizes: 12mm to 25mm & 1/2" to 13/16" I.D.		
CA1745	60	'R' Clips – Zinc Plated. 8 Sizes: 1/8" to 1" (Shaft Size)		
CA1750	61	Shim Steel Washers – 14 Sizes: 3/16" to 1" I.D. – Thickness .006"		
CA1755	61	Flat Steel Washers – Imperial, High Tensile, Zinc Plated. 10 Sizes: 1/4" to 1" I.D.		
CA1760	61	Circlips – Metric Internal and External. 14 Sizes: 6mm to 25mm		
CA1765	61	Lock Rings – External SPN Type. 10 Sizes: 1.5mm to 12mm		
CA1770	61	Aluminium Washers – Imperial and Metric. 15 Sizes: 1/4" to 1" I.D. & 5mm to 20mm I.D. – Thickness: 1/16"		
CA1772	61	Torx® Security Machine Screws – Metric, Pan Head, Z/P. 15 Sizes: M4 to M6 Dia. – Lengths 10mm to 30mm		
CA1774	62	Torx® Security Machine Screws – Metric, C/Sunk, Z/P. 13 Sizes: 4mm to 6mm – Lengths 10mm to 30mm		
CA1776	62	Torx® Security Self-Tapping Screws – Pan Head, Z/P. 17 Sizes: 6G to 10G Dia. – Lengths 13mm to 38mm		
CA1778	62	Torx® Security Self-Tapping Screws – Countersunk, Z/P. 17 Sizes: 6G to 10G Dia. – Lengths 13mm to 38mm		
CA1780	62	Star Washers – Internal and External, Zinc Plated. 14 Sizes: 4mm to 16mm		
CA1782	62	Torx® Security Self-Drilling Screws – Pan Head, Z/P. 15 Sizes: 6G to 10G Dia. – Lengths 13mm to 38mm		
CA1784	62	Torx® Security Button Head Screws – Metric, Zinc Plated. 14 Sizes: M4 to M8 Dia. – Lengths 16 to 30mm		
CA1786	63	Machine Screws – Metric, Countersunk, Zinc Plated. 13 Sizes: M3 to M6 Dia. – Lengths 16 to 50mm		
CA1790	63	Drain (Sump) Plug Washers – Aluminium Met & Imp. 8 Sizes: 12-24mm I.D. & 1/2" I.D. – Thickness: 2.5mm		

Torx® is a registered trademark of Camcar Textron Inc.

ASSORTMENTS NUMERICAL LISTING

PART NO.	IMAGE PAGE NO.	PRODUCT	MASTER KITS	STAINLESS STEEL
CA1792	63	Nylon Nuts – Metric, Wing, Dome and Hex Nuts. 9 Sizes: M5 to M8 Dia. & 5mm to 8mm		
CA1794	63	Wing Nuts – Metric and UNC, Zinc Plated. 9 Sizes: M4 to M10, UNC 3/16" to 3/8"		
CA1796	63	Coupling Nuts – Metric and UNC, Zinc Plated. 10 Sizes: M5 to M12 & 3/16" to 7/16"		
CA1798	63	Wing Screws – Metric, Zinc Plated. 8 Sizes: M4 to M6 Dia. – Lengths 16mm to 40mm		
CA1800	66	Stainless Steel Assortment – Bolts and Nuts, Screws, Washers and Split Pins, 304/A2. 38 Sizes		●
CA1808	66	Stainless Steel Grease Nipples – Metric and Imperial, 316/A4. 14 Sizes		●
CA1810	66	Stainless Steel Self-Tapping Screws – Pan Head, Phillips, 304/A2. 15 Sizes: 4G to 10G – Lengths 1/2" to 1-1/2"		●
CA1815	66	Stainless Steel Roll Pins – Metric, 304/A2. 14 Sizes: 2mm to 6mm Dia.		●
CA1816	66	Stainless Steel (Grub) Screws – Metric and Imperial, 316/A4. 14 Sizes: 5mm to 8mm & 3/16" to 3/8" BSW		●
CA1817	66	Stainless Steel Cap Screws – Metric, 316/A4. 14 Sizes: 5mm to 10mm		●
CA1818	66	Stainless Steel Cap Screws – BSW, 316/A4. 14 Sizes: 3/16" to 3/8" – Lengths to 1-1/2"		●
CA1820	67	Stainless Steel Self-Tapping Screws – Countersunk, Phillips, 304/A2. 15 Sizes: 4G to 10G – Lengths to 1-1/2"		●
CA1824	67	Stainless Steel 'E' Clips – Metric, 304/A2. 8 Sizes: 1.9mm to 15mm		●
CA1830	67	Stainless Steel Flat and Panel Washers – 304/A2. 16 Sizes: 1/8" to 3/4" I.D. 6mm & 12mm Metric		●
CA1840	67	Stainless Steel Spring Washers – 304/A2, Imperial. 12 Sizes: 5/32" to 3/4" & 4mm to 16mm I.D.		●
CA1850	67	Stainless Steel Split Pins – Metric, 304/A2. 10 Sizes: 1.6mm to 5mm Dia.		●
CA1860	67	Stainless Steel Machine Screws and Nuts – BSW, 304/A2. 10 Sizes: 1/8" to 1/4"		●
CA1861	68	Stainless Steel Internal Circlips – Metric, 304/A2. 8 Sizes: 10mm to 25mm		●
CA1862	68	Stainless Steel External Circlips – Metric, 304/A2. 8 Sizes: 6mm to 22mm		●
CA1870	68	Stainless Steel Set Screws and Nuts – Metric, 304/A2. 13 Sizes: M4 to M10 Dia.		●
CA1875	68	Stainless Steel Set Screws and Nuts – UNC, 316/A4. 10 Sizes: 1/4" to 3/8" Dia.		●
CA1880	74	Stainless Steel Metric, Set Screws and Nuts – 304/A2. 16 Sizes: M4 to M12 Dia.	●	●
CA1882	68	Torx® Security Self-Tapping Screws – Pan Head, 304/A2. 14 Sizes: 6G to 12G Dia. – Lengths 1/2" to 1-1/2"		●
CA1884	68	Self-Tapping Screws – Raised C/Sunk, Phillips, 316/A4. 19 Sizes: 4G to 10G Dia. – Lengths 1/2" to 2"		●
CA1885	69	Stainless Steel Hex Set Screws & Nuts – Metric, 316/A4. 13 Sizes: 4mm to 10mm Dia. – Lengths 16 to 50mm		●
CA1886	69	Torx® Security Machine Screws – Pan Head, 304/A2. 14 Sizes: M5 to M8 Dia. – Lengths 10 to 30mm		●
CA1888	69	Machine Screws & Nuts – Pan Hd, Phillips, 316/A4. 14 Sizes: M5 to M6 Dia. – Lengths 10 to 50mm		●
CA1890	69	Security Machine Screws & Nuts – C/Sunk, Phillips, 316/A4. 11 Sizes: M5 to M6 Dia. – Lengths 16 to 50mm		●
CA1892	69	Stainless Steel Wing Screws & Nuts – Metric, 316/A4. 11 Sizes: M4 to M6 – Lengths 10mm to 25mm		●
CA1894	69	Stainless Steel Blind Rivets – 304/A2. 16 Sizes: 2.4mm to 5mm Dia.		●
CA2005	74	Fuses – Glass, Blade and European. 28 Sizes: 2 Amp. to 50 Amp. – 24 Types	●	
CA2010	74	Circlips – Metric, Internal. 20 Sizes: 8mm to 50mm (Bore Size)	●	
CA2015	74	Circlips – Metric, External. 20 Sizes: 6mm to 50mm (Shaft Size)	●	
CA2020	74	Roll Pins – Metric. 24 Sizes: 2mm to 10mm Dia. (Large Sizes)	●	
CA2025	74	Roll Pins – Imperial. 24 Sizes: 3/32" to 3/8" Dia.	●	
CA2030	75	Circlips – Imperial, Internal. 20 Sizes: 1/4" to 2" Bore Size	●	
CA2035	75	Circlips – Imperial, External. 20 Sizes: 1/4" to 2" Shaft Size	●	
CA2040	75	Wiring Terminals – Crimp Type. 28 Types incl. Push-On Bullet, Ring, Tab, Splice and Lanced	●	
CA2045	75	Self-Tapping Screws – Pan and Mushroom Head, Phillips, Black Zinc. 28 Sizes: 6G to 12G – Lengths to 2"	●	
CA2050	75	Flat & Spring Steel Washers – Imperial and Metric, Zinc Plated. 25 Sizes: 5/32" to 3/4" & 6 to 20mm I.D.	●	
CA2060	75	Fibre Washers – 36 Sizes: 5/32" to 1" & 14mm to 30mm I.D. – Thickness: 1/32", 1/16", 3/32"	●	
CA2070	76	Brass Hose Fittings – 'T' Pieces, Joiners, Tails, Elbows and Adaptors. 53 Sizes, 106 Pieces	●	
CA2075	76	Vacuum Hose and Tube Connectors – 49 Sizes, 136 Pieces	●	
CA2080	76	Trim Clips – Scrivets. 16 Types, 675 Pieces	●	
CA2085	76	Trim Clips – Xmas Tree Clips. 16 Types, 690 Pieces	●	
CA2096	76	Manifold Studs and Nuts – Metric and Imperial, Steel & Brass, Zinc Passivated. 19 Sizes	●	
CA2140	76	Drain (Sump) Plug Washers – Fibre, Aluminium & Copper Crush Metric. 25 Sizes: 12mm to 25mm I.D.	●	

Torx® is a registered trademark of Camcar Textron Inc.

NUMERICAL LISTING ASSORTMENTS

PART NO.	IMAGE PAGE NO.	PRODUCT	MASTER KITS	STAINLESS STEEL
CA2173	77	Bonded Seal (Dowty) Washers – Metric and Imperial. 22 Sizes: 8mm to 42mm & 1/8" to 1-1/4" I.D. BSP	●	
CA2174	77	Rubber Grommets – Wiring and Blanking. 20 Sizes: 1/8" to 1-1/8"	●	
CA2177	77	Woodruff Keys – Imperial and Metric. 34 Sizes: 3/32" to 3/8" & 2mm to 10mm Dia.	●	
CA2206	77	6mm Bolts & Nuts – H/T GR8.8, incl. Self-Lock Nuts & Washers. Set Screws & Flange Hd Lengths: 16 to 40mm	●	
CA2208	77	8mm Bolts & Nuts – H/T GR8.8, incl. Self-Lock Nuts & Washers. Set Screws & Flange Hd Lengths: 20 to 50mm	●	
CA2210	77	10mm Bolts & Nuts – H/T GR8.8, incl. Self-Lock Nuts & Washers. Set Screws & Flange Hd Lengths: 25 to 50mm	●	
CA2240	78	Flat & Body Steel Washers – Imperial and Metric, Zinc Plated. 20 Sizes: 1/8" to 1" & 6mm to 12mm I.D.	●	
CA2260	78	Fuel Injection Copper Washers – Metric. 24 Sizes: 5mm to 26mm I.D. – Thickness: 1, 1.5 & 2mm	●	
CA2265	78	Plastic Trim Clips and Screw Grommets – 20 Sizes, 275 Pieces	●	
CA2276	78	Shim Steel Washers – 36 Sizes: 3/16" to 1-3/8" I.D. and .006" Thickness	●	
CA2300	78	Socket Head Cap Screws – BSW, High Tensile, 25 Sizes: 3/16" x 5/8" to 1/2" x 2-1/4"	●	
CA2370	78	UNC Bolts, Set Screws and Nuts – High Tensile, GR8. 17 Sizes: 1/4" to 1/2" Dia. Lengths: 3/4" to 2"	●	
CA2385	79	Fuses – Blade, Circuit Breaker, Micro and Mini Blades. 3 Amp. to 30 Amp. – 24 Types	●	
CA2415	79	Grease Nipples – Combination Metric and Imperial, Zinc Plated. 20 Sizes	●	
CA2417	79	Socket Head Cap Screws – Metric, GR8.8, Zinc Plated. 24 Sizes: 3mm to 8mm Dia.	●	
CA2431	79	Metric Bolts, Set Screws & Nuts – High Tensile, Z/P. 6 to 12mm Dia. Lengths: 20mm to 50mm	●	
CA2540	79	Split Pins – Metric, Zinc Plated. 16 Sizes: 1.6mm x 22mm to 6.3mm x 50mm	●	
CA2700	79	Wiring Terminals – Crimp Type incl. Adjustable Ratchet Crimp Tool. Suits: 3, 4 & 5mm Wire. 20 Types	●	
CA2705	80	Machine Screws – Pan Head, Phillips, Zinc Plated. 24 Sizes: M3 to M6 Dia.	●	
CA2710	80	Machine Screws and Nuts – Metric, Countersunk Head, Zinc Plated. 20 Sizes: M3 to M6 Dia.	●	
CA2715	80	Sems Assembly – Metric, Single and Double Washers, Zinc Passivated. 20 Sizes: M5 to M10 Dia.	●	
CA2788	80	Nylon Bolts and Nuts – Hex Head. 19 Sizes: 5, 6 & 8mm Dia.	●	
CBA1	220	Case of Bolts – UNC & UNF, H/T, GR5, Bolts & Set Screws, Nuts to Suit. 38 Sizes: 1/4" to 1/2" Dia, 600pce		
CFM1	220	Case of Bolts – Metric, Fine Pitch, H/T, GR8, Bolts & Set Screws, Nuts to Suit. 39 Sizes: M6 to M12, 600pce		
CHCA120	137	Hose Clamps – Stainless Steel (Zinc Plated Screw). 9 Sizes: 6-16mm to 40-64mm, 120 Pieces		●
CMA1	220	Case of Bolts – Metric, H/T, GR8.8, Bolts and Set Screws, Nuts to Suit. 37 Sizes: M5 to M16, 600 Pieces		
CTRK3NC	209	Imperial 3/16 UNC – incl. Tap, Drill Bit, Installation Tool, Break-off Tool and Thread Inserts		●
CTRK4NC	209	Imperial 1/4 UNC – incl. Tap, Drill Bit, Installation Tool, Break-off Tool and Thread Inserts		●
CTRK5NC	209	Imperial 5/16 UNC – incl. Tap, Drill Bit, Installation Tool, Break-off Tool and Thread Inserts		●
CTRK6NC	209	Imperial 3/8 UNC – incl. Tap, Drill Bit, Installation Tool, Break-off Tool and Thread Inserts		●
CTRK3NF	209	Imperial 3/16 UNF – incl. Tap, Drill Bit, Installation Tool, Break-off Tool and Thread Inserts		●
CTRK4NF	209	Imperial 1/4 UNF – incl. Tap, Drill Bit, Installation Tool, Break-off Tool and Thread Inserts		●
CTRK5NF	209	Imperial 5/16 UNF – incl. Tap, Drill Bit, Installation Tool, Break-off Tool and Thread Inserts		●
CTRK6NF	209	Imperial 3/8 UNF – incl. Tap, Drill Bit, Installation Tool, Break-off Tool and Thread Inserts		●
CTRK508	209	Metric 5mm x 0.8 – incl. Tap, Drill Bit, Installation Tool, Break-off Tool and Thread Inserts		●
CTRK6100	209	Metric 6mm x 1.00 – incl. Tap, Drill Bit, Installation Tool, Break-off Tool and Thread Inserts		●
CTRK8125	209	Metric 8mm x 1.25 – incl. Tap, Drill Bit, Installation Tool, Break-off Tool and Thread Inserts		●
CTRK10150	209	Metric 10mm x 1.50 – incl. Tap, Drill Bit, Installation Tool, Break-off Tool and Thread Inserts		●
CTRK10125	209	Metric 10mm x 1.25 – incl. Tap, Drill Bit, Installation Tool, Break-off Tool and Thread Inserts		●
CTRKMET-5	209	Metric Sizes: 5, 6, 8, 10 & 12mm – incl. 5 x Tap Sizes, Insert Tools, Tang Break-off Tools and Drill Bits		●
BBIMP	220	Bucket of Bolts – Imperial, H/T, GR5, Nuts, Flat & Spring Washers to Suit, Z/P. 20 Sizes: 1/4" to 1/2" Dia.		
BBMET	220	Bucket of Bolts – Metric, H/T, GR8.8, Nuts, Flat and Spring Washers to Suit, Z/P. 20 Sizes: M6 to M12		



**CHAMPION ASSORTMENTS
STAINLESS STEEL & MASTER KITS**

RANGE OF ASSORTMENTS

RANGE OF ASSORTMENTS



ALIGNMENT SHIMS

CA106	Pg 45	Wheel Alignment Shims, Imperial. 12 Sizes for GM & Ford Vehicles, 4 Types in 1/32", 1/16" & 1/8" Thickness	131 Pieces		
CA107	Pg 45	Wheel Alignment Shims, Metric. 11 Sizes – Thickness: 1, 1.5, 2 & 3mm	100 Pieces		



BOLTS & NUTS

UNC

CA125	Pg 47	Set Screws and Nuts. High Tensile, GR5, Zinc Plated. 11 Sizes: 1/4" to 3/8" Dia.	113 Pieces		
CA370	Pg 73	Bolts, Set Screws and Nuts. High Tensile, GR5, Zinc Plated. 16 Sizes: 1/4" to 1/2" Dia.	370 Pieces	●	
CA2370	Pg 78	Bolts, Set Screws and Nuts. High Tensile, GR8. 17 Sizes: 1/4" to 1/2" Dia. Lengths: 3/4" to 2"	393 Pieces	●	

UNF

CA120	Pg 46	Set Screws and Nuts. High Tensile, GR5, Zinc Plated. 11 Sizes: 1/4" to 3/8" Dia.	113 Pieces		
CA365	Pg 73	Bolts, Set Screws and Nuts. High Tensile, GR5, Zinc Plated. 16 Sizes: 1/4" to 1/2" Dia.	365 Pieces	●	

METRIC

CA196	Pg 49	Set Screws with Nuts. High Tensile, GR8.8, Zinc Plated. 13 Sizes: M4 to M10 Dia.	221 Pieces		
CA200	Pg 49	Flange Head Hex Set Screws and Nuts. High Tensile, GR8.8, Zinc Plated. 14 Sizes: 5mm to 10mm	202 Pieces		
CA431	Pg 73	Bolts, Set Screws and Nuts. High Tensile, GR8.8, Zinc Plated. 17 Sizes: M4 to M12 Dia.	431 Pieces	●	
CA495	Pg 73	Flange Head Hex Set Screws & Nuts. High Tensile, GR8.8, Zinc Plated. 17 Sizes: 5mm to 10mm Dia.	455 Pieces	●	
CA2431	Pg79	Bolts, Set Screws and Nuts. High Tensile, Zinc Plated. 6 to 12mm Dia. Lengths: 20mm to 50mm	364 Pieces	●	

METRIC FINE

CA480	Pg 73	Bolts, Set Screws and Nuts. ISO and Fine Pitch, High Tensile, GR8.8, Z/P. 16 Sizes: M4 to M12 Dia.	480 Pieces	●	
CA1480	Pg 58	Hex Set Screws and Nuts. Metric GR8.8, ISO and Fine Pitch, Zinc Plated. 9 Sizes: M6 to M12 Dia.	139 Pieces		
CA2206	Pg 77	6mm H/T GR8.8, incl. Self-Locking Nuts & Washers, Z/P. Set Screws & Flange Head Lengths: 16 to 40mm	753 Pieces	●	
CA2208	Pg 77	8mm H/T GR8.8, incl. Self-Locking Nuts & Washers, Z/P. Set Screws & Flange Head Lengths: 20 to 50mm	508 Pieces	●	
CA2210	Pg 77	10mm H/T GR8.8, incl. Self-Locking Nuts & Washers, Z/P. Set Screws & Flange Head Lengths: 25 to 50mm	401 Pieces	●	

NYLON

CA1792	Pg 63	Metric, Nylon Nuts; Wing, Dome and Hex Nuts. 9 Sizes: M5 to M8 Dia. & 5mm to 8mm	255 Pieces		
CA2788	Pg 80	Nylon Bolts and Nuts. Hex Head. 19 Sizes: 5, 6 & 8mm Dia.	565 Pieces	●	

STAINLESS STEEL METRIC / UNC

CA1870	Pg 68	Set Screws and Nuts. 13 Sizes: M4 to M10 Dia.	174 Pieces		●
CA1875	Pg 68	Set Screws and Nuts, UNC. 10 Sizes: 1/4" to 3/8" Dia.	140 Pieces		●
CA1880	Pg 74	Set Screws and Nuts. 16 Sizes: M4 to M12 Dia.	316 Pieces	●	●
CA1885	Pg 69	Set Screws and Nuts. Metric, Stainless Steel, 316/A4. 13 Sizes: 4-10mm Dia. – Lengths: 16-50mm	328 Pieces		●

● Master Kits ● Stainless Steel



BRASS

CA70	Pg 43	Adaptors, Tails, Elbows, Nuts and Connectors. 20 Types	59 Pieces		
CA132	Pg 47	Olives, Unions, Flare Nuts and Reducing Bushes. 33 Types	111 Pieces		
CA134	Pg 47	Single and Double Unions, Nuts and Elbows. 22 Types	110 Pieces		
CA178	Pg 49	Single and Double Unions, Dole Nuts, M/F Elbows, Nipples and Plugs. 32 Types	155 Pieces		
CA1412	Pg 56	Brass Olives for Copper and Nylon Tube. Sizes: Copper 1/8" to 1/2" and Nylon 3/16" to 3/8"	330 Pieces		
CA2070	Pg 76	Brass Hose Fittings: 'T' Pieces, Joiners, Tails, Elbows and Adaptors. 53 Sizes	106 Pieces	●	



CLIPS & CLAMPS

CIRCLIPS IMPERIAL

CA155	Pg 48	Internal and External. 14 Sizes: 1/4" to 1"	155 Pieces		
CA2030	Pg 75	Internal. 20 Sizes: 1/4" to 2" (Bore Size)	240 Pieces	●	
CA2035	Pg 75	External. 20 Sizes: 1/4" to 2" (Shaft Size)	240 Pieces	●	

CIRCLIPS METRIC

CA1760	Pg 61	Internal and External. 14 Sizes: 6mm to 25mm	155 Pieces		
CA1861	Pg 68	Stainless Steel Internal Circlips 304/A2. 8 Sizes: 10mm to 25mm	80 Pieces	●	
CA1862	Pg 68	Stainless Steel External Circlips 304/A2. 8 Sizes: 6mm to 22mm	120 Pieces	●	
CA2010	Pg 74	Internal. 20 Sizes: 8mm to 50mm (Bore Size)	260 Pieces	●	
CA2015	Pg 74	External. 20 Sizes: 6mm to 50mm (Shaft Size)	260 Pieces	●	

CLAMPS

CA22	Pg 42	Pipe Support Anchors, Metal with Rubber Protector	28 Pieces		
CA124	Pg 47	Nylon Cable 'P' Clamps and Cable Tie Mounts	124 Pieces		
CHCA120	Pg 137	Stainless Steel Hose Clamps. 9 Sizes: 6-16mm to 40-64mm (Zinc Plated Screw)	120 Pieces	●	

'E' CLIPS / RETAINER SPRINGS & SNAP RINGS

CA1424	Pg 58	'E' Clips 10 Sizes: 3/32" to 5/8" (Shaft Size). Retainer Springs 4 Sizes: 11/64" to 17/32" (Shaft Size)	740 Pieces		
CA1824	Pg 67	Stainless Steel 'E' Clips, Metric 304/A2. 8 Sizes: 1.9mm to 15mm	325 Pieces	●	
CA1765	Pg 61	SPN Type External Lock Rings. 10 Sizes: 1.5mm to 12mm	825 Pieces		

'R' CLIPS

CA1745	Pg 60	'R' Clips, Zinc Plated. 8 Sizes: 1/8" to 1" (Shaft Size)	124 Pieces		
---------------	-------	--	------------	--	--

● Master Kits ● Stainless Steel



CLIPS & CLAMPS *Continued*

TRIM CLIPS

CA1735	Pg 60	Plastic Trim Clips and Screw Grommets. 14 Sizes	180 Pieces		
CA2265	Pg 78	Plastic Trim Clips and Screw Grommets. 20 Sizes	275 Pieces	●	
CA2080	Pg 76	Scrivets. 16 Types	675 Pieces	●	
CA2085	Pg 76	Xmas Tree Clips. 16 Types	690 Pieces	●	



FUSES

AF BLADE TYPE

CA110	Pg 45	8 Sizes: 3, 5, 7.5, 10, 15, 20, 25 & 30 Amp.	110 Pieces		
--------------	-------	--	------------	--	--

AF CIRCUIT BREAKER

CA113	Pg 46	7 Sizes: 5, 7.5, 10, 15, 20, 25, 30 Amp.	35 Pieces		
--------------	-------	--	-----------	--	--

BLADE, CIRCUIT BREAKER, MICRO & MINI BLADES

CA2385	Pg 79	3 Amp. to 30 Amp. 24 Types	400 Pieces	●	
---------------	-------	----------------------------	------------	---	--

COMBINATION BLADE, GLASS & EUROPEAN TYPES

CA105	Pg 44	14 Sizes: Glass 3 to 35 Amp. Blade 10 to 20 Amp. European 8 to 25 Amp.	100 Pieces		
--------------	-------	--	------------	--	--

CA2005	Pg 74	28 Sizes: Glass 2 to 50 Amp. Blade 5 to 30 Amp. European 8 to 25 Amp.	300 Pieces	●	
---------------	-------	---	------------	---	--

LOW PROFILE BLADE TYPE

CA111	Pg 45	8 Sizes: 3, 5, 7.5, 10, 15, 20, 25 & 30 Amp.	120 Pieces		
--------------	-------	--	------------	--	--

MINI BLADE TYPE

CA112	Pg 46	8 Sizes: 3, 5, 7.5, 10, 15, 20, 25 & 30 Amp.	120 Pieces		
--------------	-------	--	------------	--	--

● Master Kits ● Stainless Steel



GREASE NIPPLES

COMBINATION

CA2415	Pg 79	Combination Imperial and Metric Grease Nipples, Zinc Plated. 20 Sizes	410 Pieces	●
---------------	-------	---	------------	---

IMPERIAL

CA108	Pg 45	Straight and Angle Nipples, UNF, BSF, BSP and NPT Threads. 15 Sizes	113 Pieces	
--------------	-------	---	------------	--

METRIC

CA109	Pg 45	Straight and Angle Nipples, Fine and Coarse. 12 Sizes: 6mm to 10mm Dia.	105 Pieces	
--------------	-------	---	------------	--

STAINLESS STEEL

CA1808	Pg 66	Stainless Steel Grease Nipples, Metric and Imperial, 316/A4. 14 Sizes	170 Pieces	●
---------------	-------	---	------------	---



GROMMETS

BLANKING

CA90	Pg 43	Blanking Grommets, Rubber. 8 Sizes: 5/16" to 1-1/8" (Panel Hole Size)	91 Pieces	
-------------	-------	---	-----------	--

COMBINATION

CA2174	Pg 77	Rubber Grommets, Wiring and Blanking. 20 Sizes: 1/8" to 1-1/8"	174 Pieces	●
---------------	-------	--	------------	---

WIRING

CA63	Pg 43	Wiring Grommets, Rubber. 12 Sizes: 1/8" to 29/32" (Wire Hole Size)	83 Pieces	
-------------	-------	--	-----------	--



GRUB SCREWS

SOCKET SET

CA1416	Pg 57	Socket Set, Metric GR8.8 and Imperial. 14 Sizes: 5mm to 8mm & 3/16" to 3/8" BSW	164 Pieces	
---------------	-------	---	------------	--

STAINLESS STEEL

CA1816	Pg 66	Stainless Steel, Metric and Imperial, 316/A4. 14 Sizes: 5mm to 8mm & 3/16" to 3/8" BSW	140 Pieces	●
---------------	-------	--	------------	---

● Master Kits ● Stainless Steel



LINKAGES (BALL JOINTS)

90° & INLINE

CA1320	Pg 56	90° and Inline Linkages Light, Heavy Duty and Spring Loaded Types, Z/P. 10 Sizes: 3/16" to 5/16"	20 Pieces		
---------------	-------	--	-----------	--	--



NUTS

BRASS MANIFOLD

CA95	Pg 43	UNC, UNF, BSF, Metric Fine and Coarse Pitch. 17 Sizes	83 Pieces		
-------------	-------	---	-----------	--	--

COUPLING

CA1796	Pg 63	Metric and UNC, Zinc Plated. 10 Sizes: M5 to M12 & 3/16" to 7/16"	92 Pieces		
---------------	-------	---	-----------	--	--

HEX FLANGE

CA100	Pg 44	Zinc Plated. 8 Sizes: 5mm to 12mm, incl. M10 to M12 Fine Pitch	140 Pieces		
--------------	-------	--	------------	--	--

PLAIN & SELF-LOCKING

CA300	Pg 51	Metric, Zinc Plated. 12 Sizes: Plain Nuts M3 to M10, Self-Locking Nuts M4 to M10	320 Pieces		
--------------	-------	--	------------	--	--

CA1765	Pg 61	SPN Type External Lock Rings. 10 Sizes: 1.5mm to 12mm	825 Pieces		
---------------	-------	---	------------	--	--

NYLON NUTS, NYLON INSERT & SELF-LOCKING

CA126	Pg 47	UNC and UNF, Zinc Plated. 12 Sizes: 3/16" to 1/2"	131 Pieces		
--------------	-------	---	------------	--	--

CA270	Pg 50	Metric, Zinc Plated. 10 Sizes: M5 x 0.8 to M12 x 1.75	270 Pieces		
--------------	-------	---	------------	--	--

CA360	Pg 51	Metric, UNC & UNF, Zinc Plated. 10 Sizes: M6 to M10 & 1/4" to 3/8"	166 Pieces		
--------------	-------	--	------------	--	--

CA1792	Pg 63	Nylon Nuts – Metric, Wing, Dome and Hex Nuts. 9 Sizes: M5 to M8 Dia. & 5mm to 8mm	255 Pieces		
---------------	-------	---	------------	--	--

SPEED NUTS

CA380	Pg 52	'U' and Flat Types, Zinc Passivated. 12 Sizes: 3/32" to 3/16" Dia.	390 Pieces		
--------------	-------	--	------------	--	--

WING NUTS

CA1794	Pg 63	Metric and UNC, Zinc Plated. 9 Sizes: M4 to M10, UNC 3/16" to 3/8"	240 Pieces		
---------------	-------	--	------------	--	--

CA1892	Pg 69	Stainless Steel Wing Screws and Nuts. Metric, 316/A4. 11 Sizes: M4 to M6 – Lengths 10mm to 25mm	230 Pieces		●
---------------	-------	---	------------	--	---

● Master Kits ● Stainless Steel



'O' RINGS

AIR CONDITIONING

CA411	Pg 53	Suits R134A Gas. HMBR (Green), Imperial, 70 Shore. 10 Sizes: 3/16" to 3/4"	145 Pieces		
--------------	-------	--	------------	--	--

HIGH PRESSURE

CA118	Pg 46	High Temp and High Pressure. Viton, Imperial, 75 Shore. 12 Sizes: 7/32" to 1"	110 Pieces		
--------------	-------	---	------------	--	--

CA212	Pg 49	Hydraulic and other Apps. Nitrile, Imperial, 90 Shore. 20 Sizes: 3/16" to 2" (Tube Sizes) with Removing Tool	212 Pieces		
--------------	-------	--	------------	--	--

'O' RINGS IMPERIAL

CA115	Pg 46	Nitrile, 70 Shore. 14 Sizes: 3/16" to 1" I.D.	115 Pieces		
--------------	-------	---	------------	--	--

CA407	Pg 52	Nitrile, 70 Shore. 32 Sizes: 1/8" to 2" I.D.	407 Pieces		
--------------	-------	--	------------	--	--

'O' RINGS METRIC

CA116	Pg 46	Nitrile, 70 Shore. 15 Sizes: 5mm to 25mm I.D.	130 Pieces		
--------------	-------	---	------------	--	--

CA408	Pg 52	Nitrile, 70 Shore. 32 Sizes: 3mm to 50mm I.D.	408 Pieces		
--------------	-------	---	------------	--	--

SPLICING KITS

CA409	Pg 52	Imperial, Nitrile, 70 Shore. 5 Sizes: 'O' Ring Cord .070" to .275" (36" each)	5 Pieces		
--------------	-------	---	----------	--	--

CA410	Pg 52	Metric, Nitrile, 70 Shore. 9 Sizes: 'O' Ring Cord 1.5mm to 8.5mm (900mm each)	9 Pieces		
--------------	-------	---	----------	--	--



PINS

CLEVIS PINS

CA52	Pg 42	Imperial, Zinc Plated. 9 Sizes: 1/4", 5/16", 3/8" & 7/16" Dia.	52 Pieces		
-------------	-------	--	-----------	--	--

ROLL PINS IMPERIAL

CA1421	Pg 57	18 Sizes: 1/16" to 1/4" Dia. (Small Sizes)	380 Pieces		
---------------	-------	--	------------	--	--

CA1435	Pg 58	12 Sizes: 3/16" to 3/8" Dia. (Large Sizes)	89 Pieces		
---------------	-------	--	-----------	--	--

CA2025	Pg 74	24 Sizes: 3/32" to 3/8" Dia.	364 Pieces	●	
---------------	-------	------------------------------	------------	---	--

ROLL PINS METRIC

CA1715	Pg 59	18 Sizes: 2mm to 6mm Dia. (Small Sizes)	360 Pieces		
---------------	-------	---	------------	--	--

CA1725	Pg 60	12 Sizes: 5mm to 10mm Dia. (Large Sizes)	82 Pieces		
---------------	-------	--	-----------	--	--

CA1815	Pg 66	Stainless Steel, 304/A2. 14 Sizes: 2mm to 6mm Dia.	210 Pieces	●	
---------------	-------	--	------------	---	--

CA2020	Pg 74	24 Sizes: 2mm to 10mm Dia. (Large Sizes)	360 Pieces	●	
---------------	-------	--	------------	---	--

SPLIT PINS

CA280	Pg 50	Metric, Zinc Plated. 11 Sizes: 5mm to 13mm Dia. Lengths to 150mm (Large Sizes)	93 Pieces		
--------------	-------	--	-----------	--	--

CA800	Pg 55	Imperial, Zinc Plated. 10 Sizes: 1.6mm to 4mm Dia. incl. 7/64" & 9/64" Dia.	795 Pieces		
--------------	-------	---	------------	--	--

CA1152	Pg 56	Zinc Plated. 8 Sizes: 1.6mm to 3.2mm Dia. incl. 7/64" Dia.	800 Pieces		
---------------	-------	--	------------	--	--

CA1850	Pg 67	Stainless Steel, Metric 304/A2. 10 Sizes: 1.6mm to 5mm Dia.	225 Pieces	●	
---------------	-------	---	------------	---	--

CA2540	Pg 79	Metric, Zinc Plated. 16 Sizes: 1.6mm x 22mm to 6.3mm x 50mm	1540 Pieces	●	
---------------	-------	---	-------------	---	--

Pins continued...

● Master Kits ● Stainless Steel

RANGE OF ASSORTMENTS

PINS *Continued*



TAPER PINS

CA1690	Pg 59	14 Sizes: No.0 x 1" to No.5 x 2" (Small Sizes)	140 Pieces		
CA1700	Pg 59	14 Sizes: No.4 x 2-1/2" to No.10 x 6" (Large Sizes)	33 Pieces		



PLUGS

DRAIN (SUMP) PLUGS

CA58	Pg 43	Steel, Metric and Imperial, Zinc Plated. 9 Sizes	58 Pieces		
-------------	-------	--	-----------	--	--

EXPANSION PLUGS IMPERIAL

CA38	Pg 42	Cup Type Steel, Zinc Plated. 13 Sizes: 19/32" to 2-1/16"	52 Pieces		
CA42	Pg 42	Cup Type Brass. 10 Sizes: 3/4" to 2-1/16"	35 Pieces		

EXPANSION PLUGS METRIC

CA1411	Pg 56	Cup Type Steel, Zinc Plated. 12 Sizes: 18mm to 46.5mm	48 Pieces		
CA43	Pg 42	Cup Type Brass. 12 Sizes: 20mm to 50mm	42 Pieces		
CA98	Pg 44	Steel Disc/Lens Type, Zinc Plated. 16 Sizes: 3/4" to 2"	100 Pieces		

RIVETS



CA502	Pg 53	Blind Aluminium. 10 Sizes: 3/32", 1/8", 5/32" & 3/16" Dia.	505 Pieces		
CA505	Pg 53	Rivet Nut Inserts. 5 Sizes: 4mm to 10mm Dia.	80 Pieces		
CA1894	Pg 69	Stainless Steel Blind, 304/A2. 16 Sizes: 2.4mm to 5mm Dia.	330 Pieces		●



SCREWS

BUTTON HEAD

CA1420	Pg 57	Button Head Cap Screws, Metric. 14 Sizes: 4mm to 8mm Dia – Lengths to 30mm	124 Pieces		
---------------	-------	--	------------	--	--

MACHINE SCREWS & NUTS

CA228	Pg 50	Fine Thread Round Head Slotted, Nickel Plated. 11 Sizes: 6/40" to 10/32"	300 Pieces		
CA21	Pg 42	Metric, Pan Head Phillips, Zinc Plated. 12 Sizes: 3mm to 6mm x 10mm to 25mm Long	520 Pieces		
CA252	Pg 50	Mushroom Head Slotted, UNC, Zinc Plated. 8 Sizes: 3/16" to 1/4"	300 Pieces		
CA2705	Pg 80	Pan Head, Phillips, Zinc Plated. 24 Sizes: M3 to M6 Dia.	1785 Pieces	●	
CA2710	Pg 80	Countersunk Head, Zinc Plated. 20 Sizes: M3 to M6 Dia.	1650 Pieces	●	
CA1786	Pg 63	Metric, Countersunk Head, Zinc Plated. 13 Sizes: M3 to M6 Dia. – Lengths 16mm to 50mm	345 Pieces		
CA290	Pg 51	Round Head Slotted, BSW, Zinc Plated. 8 Sizes: 1/8" x 3/4" to 1/4" x 2"	360 Pieces		
CA1888	Pg 69	Pan Head, Phillips, 316/A4. 14 Sizes: M5 to M6 Dia. – Lengths 10mm to 50mm	345 Pieces		●
CA1890	Pg 69	Countersunk Head, Phillips, 316/A4. 11 Sizes: M5 to M6 Dia. – Lengths 16mm to 50mm	295 Pieces		●

Screws continued...

● Master Kits ● Stainless Steel

SCREWS *Continued*



Sems Assembly



Wing Screw

MOTORCYCLE FASTENERS

CA302	Pg 51	Metric Socket Head Cap, Machine & Hex Screws, & Star Washers, Zinc Plated. 28 Sizes	191 Pieces		
--------------	-------	---	------------	--	--

SEMS ASSEMBLY

CA2715	Pg 80	Single and Double Washers, Zinc Passivated. 20 Sizes: M5 to M10 Dia.	380 Pieces	●	
---------------	-------	--	------------	---	--

SOCKET HEAD CAP SCREWS

CA1418	Pg 57	BSW, High Tensile. 14 Sizes: 3/16" to 5/16" Dia. – Lengths to 1-1/2"	92 Pieces		
---------------	-------	--	-----------	--	--

CA2300	Pg 78	BSW, High Tensile. 25 Sizes: 3/16" x 5/8" to 1/2" x 2-1/4"	300 Pieces	●	
---------------	-------	--	------------	---	--

CA1417	Pg 57	Metric, High Tensile, GR8.8, 14 Sizes: M5 to M10 Dia.	90 Pieces		
---------------	-------	---	-----------	--	--

CA1419	Pg 57	Countersunk Metric, GR8.8, Sizes: 4mm to 8mm Dia. – Lengths to 30mm	124 Pieces		
---------------	-------	---	------------	--	--

CA2417	Pg 79	Metric, GR8.8, Zinc Plated. 24 Sizes: 3mm to 8mm Dia.	430 Pieces	●	
---------------	-------	---	------------	---	--

SOCKET SET (GRUB) SCREWS

CA1416	Pg 57	Metric GR8.8 and Imperial. 14 Sizes: 5mm to 8mm & 3/16" to 3/8" BSW	164 Pieces		
---------------	-------	---	------------	--	--

STAINLESS STEEL

CA214	Pg 215	Screws, Washers and Nuts, 302/A2, 316/A4. 52 Sizes	210 Pieces	●	
--------------	--------	--	------------	---	--

CA1800	Pg 66	Bolts, Screws, Washers and Split Pins, 304/A2. 38 Sizes	324 Pieces	●	
---------------	-------	---	------------	---	--

CA1816	Pg 66	Socket Set (Grub) Screws. Metric and Imperial, 316/A4. 14 Sizes: 5mm to 8mm & 3/16" to 3/8" BSW	140 Pieces	●	
---------------	-------	---	------------	---	--

CA1817	Pg 66	Cap Screws. Metric, 316/A4. 14 Sizes: 5mm to 10mm	80 Pieces	●	
---------------	-------	---	-----------	---	--

CA1818	Pg 66	Cap Screws. BSW, 316/A4. 14 Sizes: 3/16" to 3/8" – Lengths to 1-1/2"	91 Pieces	●	
---------------	-------	--	-----------	---	--

CA1860	Pg 67	Machine Screws and Nuts. BSW, 304/A2. 10 Sizes: 1/8" to 1/4"	256 Pieces	●	
---------------	-------	--	------------	---	--

CA1892	Pg 69	Wing Screws and Nuts. Metric, 316/A4. 11 Sizes: M4 to M6 – Lengths 10mm to 25mm	230 Pieces	●	
---------------	-------	---	------------	---	--

WING SCREWS

CA1798	Pg 63	Metric, Zinc Plated. 8 Sizes: M4 to M6 Dia. – Lengths 16mm to 40mm	95 Pieces		
---------------	-------	--	-----------	--	--



SECURITY SCREWS

TORX® SECURITY BUTTON HEAD

CA1784	Pg 62	Button Head, Metric, Zinc Plated. 14 Sizes: M4 to M8 Dia. – Lengths 16mm to 30mm	270 Pieces		
---------------	-------	--	------------	--	--

TORX® SECURITY SELF-TAPPING

CA1776	Pg 62	Pan Head, Zinc Plated. 17 Sizes: 6G to 10G Dia. – Lengths 13mm to 38mm	425 Pieces		
---------------	-------	--	------------	--	--

CA1778	Pg 62	Countersunk Head, Zinc Plated. 17 Sizes: 6G to 10G Dia. – Lengths 13mm to 38mm	425 Pieces		
---------------	-------	--	------------	--	--

CA1782	Pg 62	Self-Drilling, Pan Head, Zinc Plated. 15 Sizes: 6G to 10G Dia. – Lengths 13mm to 38mm	375 Pieces		
---------------	-------	---	------------	--	--

CA1882	Pg 68	Stainless Steel, Pan Head, 304/A2. 14 Sizes: 6G to 12G Dia. – Lengths 1/2" to 1-1/2"	210 Pieces	●	
---------------	-------	--	------------	---	--

Security Screws continued...

Torx® is a registered trademark of Camcar Textron Inc.

● Master Kits ● Stainless Steel

RANGE OF ASSORTMENTS

SECURITY SCREWS *Continued*

TORX® SECURITY MACHINE SCREWS

CA1772	Pg 61	Metric, Pan Head, Zinc Plated. 15 Sizes: M4 to M6 Dia. – Lengths 10mm to 30mm	365 Pieces		
CA1774	Pg 62	Countersunk Head, Zinc Plated. 13 Sizes: 4mm to 6mm Dia. – Lengths 10mm to 30mm	325 Pieces		
CA1886	Pg 69	Pan Head, 304/A2. 14 Sizes: M5 to M8 Dia. – Lengths 10mm to 30mm	140 Pieces		●



SELF-TAPPING SCREWS

CA350	Pg 51	Hex Head, Zinc Plated. 14 Sizes: 6G to 14G – Lengths to 1"	350 Pieces		
CA420	Pg 53	Raised and Pan Head Slotted, Zinc Plated. 12 Sizes: 6G to 12G – Lengths to 1"	420 Pieces		
CA430	Pg 53	Raised, Hex and Pan Head, Zinc Plated. 14 Sizes: 4G to 14G – Lengths to 1-1/2"	430 Pieces		
CA540	Pg 54	Pan and Raised Head, Phillips, Nickel Plated. 13 Sizes: 4G to 10G – Lengths to 1-1/2"	540 Pieces		
CA550	Pg 54	Pan and Raised Head, Slotted, Zinc Plated. 13 Sizes: 6G to 12G – Lengths to 1"	610 Pieces		
CA560	Pg 54	Pan Head, Slotted, Zinc Plated. 8 Sizes: 6G to 10G – Lengths to 1-1/2"	400 Pieces		
CA1710	Pg 59	Pan Head Phillips, Zinc Plated. 14 Sizes: 6G to 12G – Lengths to 2"	415 Pieces		

COMBINATION

CA1630	Pg 73	Phillips Raised, Pan Slot and Hex Head, incl. Cup Washers. Zinc and Nickel Plated. 19 Sizes: 6G to 14G	1680 Pieces	●	
---------------	-------	--	-------------	---	--

SELF-DRILLING

CA530	Pg 54	Wafer and Hex Head, Yellow Zinc. 8 Sizes: 8G & 10G – Lengths to 30mm	400 Pieces		
--------------	-------	--	------------	--	--

STAINLESS STEEL

CA1810	Pg 66	Pan Head, Phillips, 304/A2. 15 Sizes: 4G to 10G – Lengths 1/2" to 1-1/2"	415 Pieces		●
CA1820	Pg 67	Countersunk, Phillips, 304/A2. 15 Sizes: 4G to 10G – Lengths to 1-1/2"	415 Pieces		●
CA1884	Pg 68	Stainless Steel, Raised Countersunk Head, 316/A4. 19 Sizes: 4G to 10G Dia. – Lengths 1/2" to 2"	440 Pieces		●

ANTI-THEFT ONE WAY SCREWS (NUMBER PLATES)

CA570	Pg 55	Self-Tapping and 6mm Screws and Nuts, incl. Washers and Speed Nut Clips, Zinc Plated	570 Pieces		
--------------	-------	--	------------	--	--



SELF-TAPPING SCREWS (BLACK ZINC)

CA1200	Pg 56	Pan and Raised Head, Phillips, Black Zinc. 14 Sizes: 6G to 12G – Lengths to 1-1/2"	415 Pieces		
CA1720	Pg 60	Mushroom Head, Black Zinc. 14 Sizes: 6G to 12G – Lengths to 2"	415 Pieces		
CA2045	Pg 75	Pan and Mushroom Head, Phillips, Black Zinc. 28 Sizes: 6G to 12G – Lengths to 2"	830 Pieces	●	

Torx® is a registered trademark of Camcar Textron Inc.

● Master Kits ● Stainless Steel



SHIM STOCK

Steel AS1365, Brass AS1566 and Stainless Steel AS1449

BRASS

CA32 Pg 23 150mm x 150mm Sheets. 4 Sizes: .002" to .010" Thickness

CA31 Pg 23 60mm Wide Rolls. 5 Sizes: .002" to .010" Thickness

STEEL

CA34 Pg 23 150mm x 150mm Sheets. 4 Sizes: .002" to .010" Thickness

CA33 Pg 23 60mm Wide Rolls. 4 Sizes: .002" to .010" Thickness

STAINLESS STEEL

CA36 Pg 23 150mm x 150mm Sheets. 4 Sizes: .003" to .027" Thickness

BRASS ROLLS

BRASS SHEETS

CSB500 Pg 23 .002" Thickness. 150mm x 600mm

CSB700 Pg 23 .002" Thickness. 6 Sheets of 150mm x 150mm

CSB501 Pg 23 .003" Thickness. 150mm x 600mm

CSB701 Pg 23 .003" Thickness. 6 Sheets of 150mm x 150mm

CSB502 Pg 23 .005" Thickness. 150mm x 600mm

CSB702 Pg 23 .005" Thickness. 6 Sheets of 150mm x 150mm

CSB503 Pg 23 .010" Thickness. 150mm x 600mm

CSB703 Pg 23 .010" Thickness. 6 Sheets of 150mm x 150mm

STEEL ROLLS

STEEL SHEETS

CSS600 Pg 23 .002" Thickness. 150mm x 600mm

CSS800 Pg 23 .002" Thickness. 6 Sheets of 150mm x 150mm

CSS601 Pg 23 .003" Thickness. 150mm x 600mm

CSS801 Pg 23 .003" Thickness. 6 Sheets of 150mm x 150mm

CSS602 Pg 23 .005" Thickness. 150mm x 600mm

CSS802 Pg 23 .005" Thickness. 6 Sheets of 150mm x 150mm

CSS603 Pg 23 .010" Thickness. 150mm x 600mm

CSS803 Pg 23 .010" Thickness. 6 Sheets of 150mm x 150mm

● Master Kits ● Stainless Steel



SPRINGS

ACCELERATOR

CA103 Pg 44 9 Sizes: Lengths 4-1/2" to 7" and 3/16" to 7/16" Dia. 36 Pieces

COMPRESSION

CA102 Pg 44 12 Sizes: Lengths 1-1/4" to 4" and 3/16" to 3/4" Dia. 72 Pieces

EXTENSION

CA101 Pg 44 12 Sizes: Lengths 1" to 4-3/4" and 3/16" to 1/2" Dia. 48 Pieces



STUDS & NUTS

BRASS MANIFOLD NUTS

CA95 Pg 43 UNC, UNF, BSF, Metric Fine and Coarse Pitch. 17 Sizes 83 Pieces

STEEL MANIFOLD STUDS & NUTS

CA96 Pg 43 Metric and UNC. Steel Studs and Nuts, Zinc Passivated. 5 Sizes 96 Pieces

STEEL & BRASS MANIFOLD STUDS & NUTS

CA2096 Pg 76 Metric and Imperial, Zinc Passivated. 19 Sizes 200 Pieces ●



THREAD INSERT REPAIR KITS

STAINLESS STEEL IMPERIAL

CTRK3NC Pg 209 3/16" UNC – incl. Tap, Drill Bit, Installation Tool, Break-off Tool and Thread Inserts 12 Pieces ●

CTRK4NC Pg 209 1/4" UNC – incl. Tap, Drill Bit, Installation Tool, Break-off Tool and Thread Inserts 12 Pieces ●

CTRK5NC Pg 209 5/16" UNC – incl. Tap, Drill Bit, Installation Tool, Break-off Tool and Thread Inserts 12 Pieces ●

Thread Insert Repair Kits continued...

● Master Kits ● Stainless Steel

THREAD INSERT REPAIR KITS *Continued*

STAINLESS STEEL IMPERIAL					
CTRK6NC	Pg 209	3/8" UNC – incl. Tap, Drill Bit, Installation Tool, Break-off Tool and Thread Inserts	12 Pieces		●
CTRK3NF	Pg 209	3/16" UNF – incl. Tap, Drill Bit, Installation Tool, Break-off Tool and Thread Inserts	12 Pieces		●
CTRK4NF	Pg 209	1/4" UNF – incl. Tap, Drill Bit, Installation Tool, Break-off Tool and Thread Inserts	12 Pieces		●
CTRK5NF	Pg 209	5/16" UNF – incl. Tap, Drill Bit, Installation Tool, Break-off Tool and Thread Inserts	12 Pieces		●
CTRK6NF	Pg 209	3/8" UNF – incl. Tap, Drill Bit, Installation Tool, Break-off Tool and Thread Inserts	12 Pieces		●
STAINLESS STEEL METRIC					
CTRK508	Pg 209	5mm x 0.8mm – incl. Tap, Drill Bit, Installation Tool, Break-off Tool and Thread Inserts	12 Pieces		●
CTRK6100	Pg 209	6mm x 1.00mm – incl. Tap, Drill Bit, Installation Tool, Break-off Tool and Thread Inserts	12 Pieces		●
CTRK8125	Pg 209	8mm x 1.25mm – incl. Tap, Drill Bit, Installation Tool, Break-off Tool and Thread Inserts	12 Pieces		●
CTRK10150	Pg 209	10mm x 1.50mm – incl. Tap, Drill Bit, Installation Tool, Break-off Tool and Thread Inserts	12 Pieces		●
CTRK10125	Pg 209	10mm x 1.25mm – incl. Tap, Drill Bit, Installation Tool, Break-off Tool and Thread Inserts	12 Pieces		●
CTRKMET-5	Pg 209	Sizes: 5, 6, 8, 10 & 12mm, incl. 5 x Tap Sizes, Insert Tools, Tang Break-off Tools and Drill Bits	60 Pieces		●



WASHERS

ALUMINIUM					
CA1770	Pg 61	Imperial and Metric. 15 Sizes: 1/4" to 1" I.D. & 5mm to 20mm I.D. – Thickness: 1/16"	315 Pieces		
BONDED SEAL					
CA173	Pg 48	Imperial. 8 Sizes: 1/8" to 1-1/4" I.D. BSP	82 Pieces		
CA174	Pg 48	Metric. 14 Sizes: Suits 8mm I.D. to 42mm I.D.	91 Pieces		
CA2173	Pg 77	Metric and Imperial. 22 Sizes: 8mm to 42mm & 1/8" to 1-1/4" I.D. BSP	173 Pieces	●	
COPPER					
CA225	Pg 49	Imperial. 12 Sizes: 1/4" to 1" I.D. – Thickness: 20G	260 Pieces		
CA1660	Pg 58	Metric. 10 Sizes: 5mm to 24mm I.D. – Thickness: 1mm	260 Pieces		
DRAIN (SUMP) PLUG					
CA140	Pg 47	Fibre, Aluminium and Copper Crush Metric. 12 Sizes: 12mm to 25mm I.D.	102 Pieces		
CA150	Pg 48	Fibre, Metric and Imperial. 10 Sizes: 1/2" to 1" & 18mm to 30mm I.D. – Thickness: 3/32"	143 Pieces		
CA1790	Pg 63	Aluminium Metric and Imperial. 8 Sizes: 12mm to 24mm I.D. & 1/2" I.D. – Thickness: 2.5mm	100 Pieces		
CA2140	Pg 76	Fibre, Aluminium and Copper Crush Metric. 25 Sizes: 12mm to 25mm I.D.	1015 Pieces	●	
FIBRE					
CA390	Pg 52	12 Sizes: 5/32" to 3/4" I.D. – Thickness: 1/16"	405 Pieces		
CA400	Pg 52	14 Sizes: 1/8" to 1" I.D. – Thickness: 1/32"	430 Pieces		
CA825	Pg 55	14 Sizes: 1/8" to 1" I.D. – Thickness: 1/32"	825 Pieces		
CA2060	Pg 75	36 Sizes: 5/32" to 1" & 14mm to 30mm I.D. – Thickness: 1/32", 1/16", 3/32"	1023 Pieces	●	

Washers continued...

● Master Kits ● Stainless Steel

RANGE OF ASSORTMENTS

WASHERS *Continued*

FLAT & BODY STEEL

CA2240	Pg 78	Imperial and Metric, Zinc Plated. 20 Sizes: 1/8" to 1" & 6mm to 12mm I.D.	2190 Pieces	●
---------------	-------	---	-------------	---

FLAT & SPRING STEEL

CA2050	Pg 75	Imperial and Metric, Zinc Plated. 25 Sizes: 5/32" to 3/4" & 6mm to 20mm I.D.	1158 Pieces	●
---------------	-------	--	-------------	---

FLAT STEEL

CA330	Pg 51	Imperial and Metric, Zinc Plated. 10 Sizes: 3/16" to 3/4" & M10 I.D.	330 Pieces	
CA576	Pg 55	Imperial and Metric, Zinc Plated. 13 Sizes: 3/16" to 3/4" & 6mm to 20mm I.D.	695 Pieces	
CA1730	Pg 60	Panel (Body) Steel and Stainless Steel, Zinc Plated. 8 Sizes: 3/16" to 1/2" I.D.	143 Pieces	●
CA1755	Pg 61	Imperial, High Tensile, Zinc Plated. 10 Sizes: 1/4" to 1" I.D.	175 Pieces	

FLAT STEEL HEAVY DUTY

CA600	Pg 55	Imperial, Zinc Plated. 8 Sizes: 3/16" to 3/4" I.D. – Thickness: 14G	605 Pieces	
--------------	-------	---	------------	--

FLAT STEEL EXTRA HEAVY DUTY

CA1670	Pg 58	Imperial, Zinc Plated. 8 Sizes: 3/16" to 3/4" I.D. – Thickness: up to 9G	325 Pieces	
---------------	-------	--	------------	--

FUEL INJECTION COPPER

CA226	Pg 49	Metric. 14 Sizes: 6mm to 26mm I.D. – Thickness: 1, 1.5 & 2mm	305 Pieces	
CA2260	Pg 78	Metric. 24 Sizes: 5mm to 26mm I.D. – Thickness: 1, 1.5 & 2mm	565 Pieces	●

NYLON

CA1740	Pg 60	Metric and Imperial. 11 Sizes: 12mm to 25mm & 1/2" to 13/16" I.D.	160 Pieces	
---------------	-------	---	------------	--

POLYPROPYLENE

CA1460	Pg 58	Metric and Imperial. 10 Sizes: 18mm to 30mm & 1/2" to 1" I.D. – Thickness: 3mm	123 Pieces	
CA1680	Pg 59	Imperial. 16 Sizes: 1/8" to 1" I.D. – Thickness: 1/32"	490 Pieces	

SHIM STEEL

CA276	Pg 50	Imperial. 22 Sizes: 5/8" to 1-3/8" I.D. – Thickness: .006"	276 Pieces	
CA1750	Pg 61	Imperial. 14 Sizes: 3/16" to 1" I.D. – Thickness: .006"	190 Pieces	
CA2276	Pg 78	Imperial. 36 Sizes: 3/16" to 1-3/8" I.D. – Thickness: .006"	466 Pieces	●

SPACING STEEL

CA500	Pg 53	Imperial. 14 Sizes: 1/4" to 1-1/8" I.D. – Thickness: 22G (.028")	545 Pieces	
--------------	-------	--	------------	--

SPRING

CA520	Pg 54	Imperial and Metric, Zinc Plated. 11 Sizes: 5/32" to 3/4" & M4 to M16 I.D.	535 Pieces	
CA648	Pg 55	Imperial and Metric, Zinc Plated. 12 Sizes: 5/32" to 5/8" & 4mm to 20mm I.D.	933 Pieces	
CA1008	Pg 56	Square Section, Zinc Plated, Imperial. 8 Sizes: 3/16" to 3/4" I.D.	895 Pieces	

STAINLESS STEEL FLAT & PANEL

CA1830	Pg 67	304/A2, Imperial. 16 Sizes: 1/8" to 3/4" Flat & 3/16" to 3/8" Panel I.D.	385 Pieces	●
---------------	-------	--	------------	---

STAINLESS STEEL SPRING

CA1840	Pg 67	304/A2, Imperial. 12 Sizes: 5/32" to 3/4" & 4mm to 16mm I.D.	345 Pieces	●
---------------	-------	--	------------	---

STAR

CA510	Pg 54	Internal and External, Zinc Plated. 14 Sizes: 3/16" to 5/8"	500 Pieces	
CA1780	Pg 62	Internal and External, Zinc Plated. 14 Sizes: 4mm to 16mm	560 Pieces	

● Master Kits ● Stainless Steel



VACUUM HOSE CONNECTORS

CA2075	Pg 76	Vacuum Hose and Tube Connectors. 49 Sizes	136 Pieces	●
---------------	-------	---	------------	---



WIRING TERMINALS

INSULATED CRIMP TYPE

CA161	Pg 48	Insulated Crimp Type. 14 Types incl. Spade, Ring, Tab & Splice	136 Pieces	
CA2040	Pg 75	Crimp Type. 28 Types incl. Push-On Bullet, Ring, Tab, Splice & Lanced	364 Pieces	●
CA2700	Pg 79	Crimp Type incl. Adjustable Ratchet Crimp Tool. Suitable for 3, 4 & 5mm Wire. 20 Types	700 Pieces	●

CONNECTOR BLOCK

CA240	Pg 50	Wiring Connector Block, M/F with Brass Terminals. 4 Sizes: 2, 4, 6 & 8 Pin	240 Pieces	
--------------	-------	--	------------	--



WOODRUFF KEYS

COMBINATION

CA2177	Pg 77	Imperial and Metric. 34 Sizes: 3/32" to 3/8" & 2mm to 10mm Dia.	341 Pieces	●
---------------	-------	---	------------	---

IMPERIAL

CA177	Pg 48	Imperial. 17 Sizes: No.2 to No.'E' (3/32" to 3/8")	177 Pieces	
--------------	-------	--	------------	--

METRIC

CA1705	Pg 59	Metric. 17 Sizes: 2mm x 10mm to 10mm x 32mm	164 Pieces	
---------------	-------	---	------------	--

● Master Kits ● Stainless Steel



All Assortments and Kits contain a carefully selected range of components, covering the most commonly used popular products.

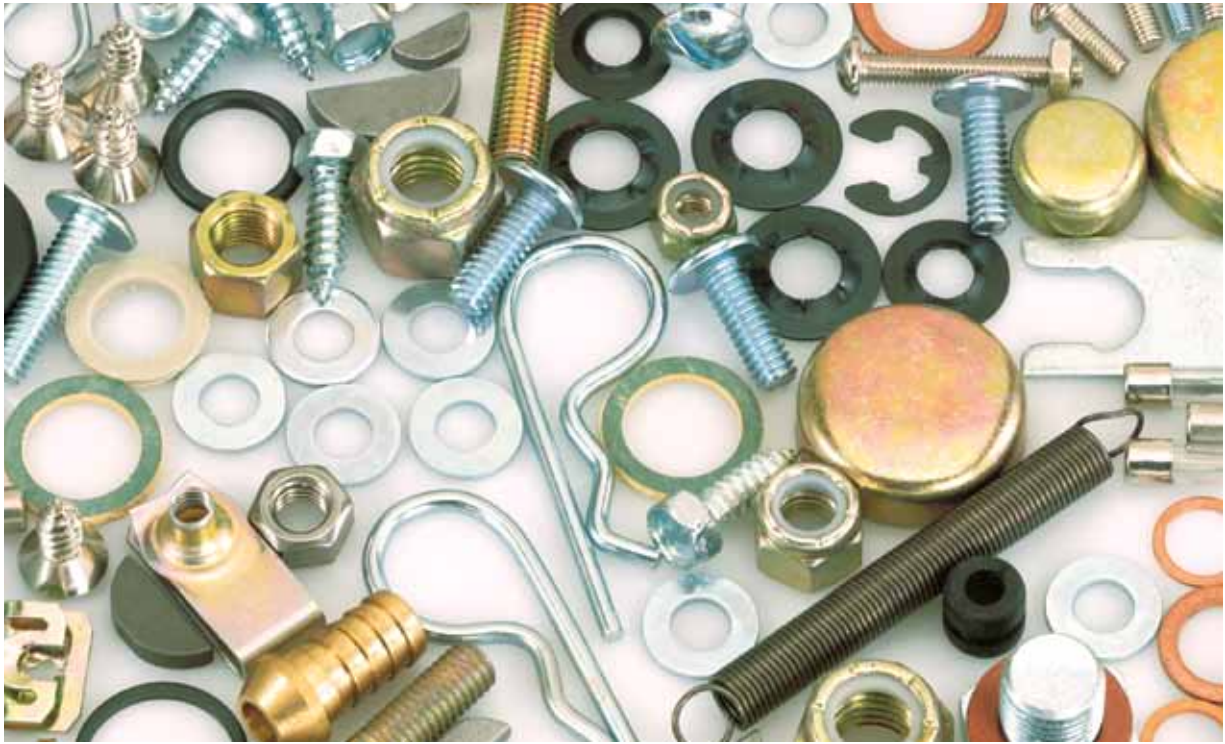

CHAMPION ASSORTMENTS & MASTER KITS



*Complete Listing of Champion Poly Box
Stainless Steel and Master Kit Assortments
in Alphabetical Sequence*

ALPHA LISTING

PRODUCT	PART NO.	IMAGE PAGE NO.	MASTER KITS	STAINLESS STEEL
ALIGNMENT SHIMS				
Wheel Alignment Shims – Imperial. 12 Sizes for GM & Ford vehicles, 4 Types: 1/32", 1/16" & 1/8" Thick	CA106	45		
Wheel Alignment Shims – Metric. 11 Sizes – Thickness: 1, 1.5, 2 & 3mm	CA107	45		
BOLTS & NUTS				
6mm Bolts & Nuts – GR8.8, incl. Self-Lock Nuts & Washers. Set Screws & Flange Hd Lengths: 16 to 40mm	CA2206	77	●	
8mm Bolts & Nuts – GR8.8, incl. Self-Lock Nuts & Washers. Set Screws & Flange Hd Lengths: 20 to 50mm	CA2208	77	●	
10mm Bolts & Nuts – GR8.8, incl. Self-Lock Nuts & Washers. Set Screws & Flange Hd Lengths: 25 to 50mm	CA2210	77	●	
Flange Head Hex Set Screws & Nuts – Metric J.I.S, High Tensile, GR8.8, Zinc Plated. 14 Sizes: 5mm to 10mm	CA200	49		
Set Screws and Nuts – Metric GR8.8, ISO and Fine Pitch, Zinc Plated. 9 Sizes: M6 to M12 Dia.	CA1480	58		
Metric Bolts, Set Screws and Nuts – High Tensile, GR8.8, Zinc Plated. 17 Sizes: M4 to M12 Dia.	CA431	73	●	
Flange Head Hex Set Screws & Nuts – Metric, High Tensile, GR8.8, Z/P. 17 Sizes: 5mm to 10mm Dia.	CA495	73	●	
Set Screws and Nuts – Metric, High Tensile, GR8.8, Zinc Plated. 13 Sizes: M4 to M10 Dia.	CA196	49		
Metric Bolts, Set Screws & Nuts – High Tensile, Z/P. 6 to 12mm Dia. Lengths: 20 to 50mm	CA2431	79	●	
Metric Bolts, Set Screws & Nuts – ISO & Fine Pitch, H/T, GR8.8, Z/P. 16 Sizes: M4 to M12 Dia.	CA480	73	●	
Stainless Steel Hex Set Screws & Nuts – Metric, 316/A4. 13 Sizes: 4-10mm Dia. – Lengths 16-50mm	CA1885	69		●
Nylon Bolts and Nuts – Hex Head. 19 Sizes: 5, 6 & 8mm Dia.	CA2788	80	●	
Stainless Steel Metric Set Screws and Nuts – 304/A2. 16 Sizes: M4 to M12 Dia.	CA1880	74	●	●
Stainless Steel Set Screws and Nuts – Metric, 304/A2. 13 Sizes: M4 to M10 Dia.	CA1870	68		●
Stainless Steel Set Screws and Nuts – UNC, 316/A4. 10 Sizes: 1/4" to 3/8" Dia.	CA1875	68		●
UNC Bolts, Set Screws and Nuts – High Tensile, GR8. 17 Sizes: 1/4" to 1/2" Dia. Lengths: 3/4" to 2"	CA2370	78	●	
UNC Bolts, Set Screws and Nuts – High Tensile, GR5, Zinc Plated. 16 Sizes: 1/4" to 1/2" Dia.	CA370	73	●	
UNC Set Screws and Nuts – High Tensile, GR5, Zinc Plated. 11 Sizes: 1/4" to 3/8" Dia.	CA125	47		
UNF Bolts, Set Screws and Nuts – High Tensile, GR5, Zinc Plated. 16 Sizes: 1/4" to 1/2" Dia.	CA365	73	●	
UNF Set Screws with Nuts – High Tensile, GR5, Zinc Plated. 11 Sizes: 1/4" to 3/8" Dia.	CA120	46		
BOLTS & NUTS Promotional Items				
Bucket of Bolts – Imperial, H/T, GR5, Nuts, Flat & Spring Washers to Suit, Z/P. 20 Sizes: 1/4" to 1/2" Dia. 900pce	BBIMP	220		
Bucket of Bolts – Metric, H/T, GR8.8, Nuts, Flat & Spring Washers to Suit, Z/P. 20 Sizes: M6 to M12, 900pce	BBMET	220		
<i>Contents for BBIMP and BBMET see page 220</i>				
Case of Bolts – Metric, H/T, GR8.8, Bolts & Set Screws with Nuts to Suit. 37 Sizes: M5 to M16, 600pce	CMA1	220		
Case of Bolts – UNC & UNF, H/T, GR5, Bolts & Set Screws, Nuts to Suit. 38 Sizes: 1/4" to 1/2" Dia, 600pce	CBA1	220		
Case of Bolts – Metric, Fine Pitch, H/T, GR8, Bolts & Set Screws, Nuts to Suit. 39 Sizes: M6 to M12, 600pce	CFM1	220		
BRASS				
Brass Fittings – Adaptors, Tails, Elbows, Nuts and Connectors. 20 Types	CA70	43		
Brass Fittings – Olives, Unions, Flare Nuts and Reducing Bushes. 33 Types	CA132	47		
Brass Fittings – Single and Double Unions, Nuts and Elbows. 22 Types	CA134	47		
Brass Fittings – Single and Double Unions, Dole Nuts, M/F Elbows, Nipples and Plugs	CA178	49		
Brass Olives – Suits Copper & Nylon Tube. Sizes: Copper 1/8" to 1/2" & Nylon 3/16" to 3/8", 330 Pieces	CA1412	56		
Brass Hose Fittings – 'T' Pieces, Joiners, Tails, Elbows and Adaptors. 53 Sizes, 106 Pieces	CA2070	76	●	

PRODUCT	PART NO.	IMAGE PAGE NO.	MASTER KITS	STAINLESS STEEL
CLIPS & CLAMPS				
Circlips – Imperial, External. 20 Sizes: 1/4" to 2" (Shaft Size)	CA2035	75	●	
Circlips – Imperial, Internal. 20 Sizes: 1/4" to 2" (Bore Size)	CA2030	75	●	
Circlips – Imperial, Internal and External. 14 Sizes: 1/4" to 1"	CA155	48		
Circlips – Metric, External. 20 Sizes: 6mm to 50mm (Shaft Size)	CA2015	74	●	
Circlips – Metric, Internal. 20 Sizes: 8mm to 50mm (Bore Size)	CA2010	74	●	
Circlips – Metric, Internal and External. 14 Sizes: 6mm to 25mm	CA1760	61		
'E' Clips and Retainer Springs – 14 Sizes: 3/32" to 5/8"	CA1424	58		
Hose Clamps – Stainless Steel (Zinc Plated Screw). 9 Sizes: 6-16mm to 40-64mm, 120 Pieces	CHCA120	137		●
Lock Rings – External SPN Type. 10 Sizes: 1.5mm to 12mm	CA1765	61		
Nylon Cable 'P' Clamps and Cable Tie Mounts – 124 Pieces	CA124	47		
Pipe Support Anchors – Metal with Rubber Protector. 28 Pieces	CA22	42		
Plastic Trim Clips and Screw Grommets – 14 Sizes, 180 Pieces	CA1735	60		
Plastic Trim Clips and Screw Grommets – 20 Sizes, 275 Pieces	CA2265	78	●	
'R' Clips – Zinc Plated. 8 Sizes: 1/8" to 1" (Shaft Size)	CA1745	60		
Stainless Steel 'E' Clips – Metric, 304/A2. 8 Sizes: 1.9mm to 15mm	CA1824	67		●
Stainless Steel External Circlips – Metric, 304/A2. 8 Sizes: 6mm to 22mm	CA1862	68		●
Stainless Steel Internal Circlips – Metric, 304/A2. 8 Sizes: 10mm to 25mm	CA1861	68		●
Trim Clips – Scrivets. 16 Types, 675 Pieces	CA2080	76	●	
Trim Clips – Xmas Tree Clips. 16 Types, 690 Pieces	CA2085	76	●	
FUSES				
Fuses – AF Blade. 8 Sizes: 3, 5, 7.5, 10, 15, 20, 25 & 30 Amp.	CA110	45		
Fuses – AF Circuit Breaker. 7 Sizes: 5, 7.5, 10, 15, 20, 25, 30 Amp.	CA113	46		
Fuses – Blade, Circuit Breaker, Micro and Mini Blades. 3 Amp. to 30 Amp. – 24 Types	CA2385	79	●	
Fuses – Glass, Blade and European. 14 Sizes: 3 Amp. to 35 Amp.	CA105	44		
Fuses – Glass, Blade and European. 28 Sizes: 2 Amp. to 50 Amp. – 24 Types	CA2005	74	●	
Fuses – Low Profile Blade. 8 Sizes: 3, 5, 7.5, 10, 15, 20, 25 & 30 Amp.	CA111	45		
Fuses – Mini Blade. 8 Sizes: 3, 5, 7.5, 10, 15, 20, 25 & 30 Amp.	CA112	46		
GREASE NIPPLES				
Grease Nipples – Straight and Angle Nipples. UNF, BSF, BSP and NPT Threads. 15 Sizes	CA108	45		
Grease Nipples – Straight and Angle Nipples. Metric, Fine and Coarse. 12 Sizes: 6mm to 10mm Dia.	CA109	45		
Grease Nipples – Combination Metric and Imperial, Zinc Plated. 20 Sizes	CA2415	79	●	
Stainless Steel Grease Nipples – Metric and Imperial, 316/A4. 14 Sizes	CA1808	66		●
GROMMETS				
Blanking Grommets – Rubber. 8 Sizes: 5/16" to 1-1/8" (Panel Hole Size)	CA90	43		
Rubber Grommets – Wiring and Blanking. 20 Sizes: 1/8" to 1-1/8"	CA2174	77	●	
Wiring Grommets – Rubber. 12 Sizes: 1/8" to 29/32" (Wire Hole Size)	CA63	43		

PRODUCT	PART NO.	IMAGE PAGE NO.	MASTER KITS	STAINLESS STEEL
GRUB SCREWS				
Stainless Steel (Grub) Screws – Metric & Imperial, 316/A4. 14 Sizes: 5 to 8mm & 3/16" to 3/8" BSW	CA1816	66		●
Socket Set (Grub) Screws – Metric GR8.8 & Imperial. 14 Sizes: 5 to 8mm & 3/16" to 3/8" BSW	CA1416	57		
LINKAGES				
Linkages (Ball Joints) – 90° and Inline, Zinc Plated. 10 Sizes: 3/16" to 5/16"	CA1320	56		
NUTS				
Brass Manifold Nuts – UNC, UNF, BSF, Metric Fine and Coarse Pitch. 17 Sizes	CA95	43		
Coupling Nuts – Metric and UNC, Zinc Plated. 10 Sizes: M5 to M12 & 3/16" to 7/16"	CA1796	63		
Flange Nuts – Zinc Plated. 8 Sizes: 5mm to 12mm, incl. M10 to M12 Fine Pitch	CA100	44		
Hex Nuts – Metric, Zinc Plated. 12 Sizes: Plain Nuts M3 to M10, Self-Locking Nuts M4 to M10	CA300	51		
Lock Rings – External SPN Type. 10 Sizes: 1.5mm to 12mm	CA1765	61		
Nylon Nuts – Metric, Wing, Dome and Hex Nuts. 9 Sizes: M5 to M8 Dia. & 5mm to 8mm	CA1792	63		
Rivet Nut Inserts – 5 Sizes: 4mm to 10mm Dia.	CA505	53		
Self-Locking Nuts, Nylon Insert – Metric, Zinc Plated. 10 Sizes: M5 x 0.8 to M12 x 1.75	CA270	50		
Self-Locking Nuts, Nylon Insert – Metric, UNC, UNF & Zinc Plated. 10 Sizes: M6 to M10 & 1/4" to 3/8"	CA360	51		
Self-Locking Nuts, Nylon Insert – UNC and UNF, Zinc Plated. 12 Sizes: 3/16" to 1/2"	CA126	47		
Speed Nuts – 'U' and Flat Types, Zinc Passivated. 12 Sizes: 3/32" to 3/16" Dia.	CA380	52		
Wing Nuts – Metric and UNC, Zinc Plated. 9 Sizes: M4 to M10, UNC 3/16" to 3/8"	CA1794	63		
Wing Screws and Nuts – Metric, Stainless Steel, 316/A4. 11 Sizes: M4 to M6 – Lengths 10 to 25mm	CA1892	69		●
'O' RINGS				
Air Conditioning 'O' Rings – Suits R134A Gas. HMBR (Green), Imperial, 70 Shore. 10 Sizes: 3/16" to 3/4"	CA411	53		
High Pressure Series 'O' Rings – Nitrile, Imperial, 90 Shore. 20 Sizes: 3/16" to 2" with Removing Tool	CA212	49		
High Temp and High Pressure 'O' Rings – Viton, Imperial, 75 Shore. 12 Sizes: 7/32" to 1"	CA118	46		
Imperial 'O' Rings – Nitrile, 70 Shore. 14 Sizes: 3/16" to 1" I.D.	CA115	46		
Imperial 'O' Rings – Nitrile, 70 Shore. 32 Sizes: 1/8" to 2" I.D.	CA407	52		
Metric 'O' Rings – Nitrile, 70 Shore. 15 Sizes: 5mm to 25mm I.D.	CA116	46		
Metric 'O' Rings – Nitrile, 70 Shore. 32 Sizes: 3mm to 50mm I.D.	CA408	52		
'O' Ring Splicing Kit – Nitrile, Imperial, 70 Shore. 5 Sizes: 'O' Ring Cord .070" to .275" (36" each)	CA409	52		
'O' Ring Splicing Kit – Nitrile, Metric, 70 Shore. 9 Sizes: 'O' Ring Cord 1.5mm to 8.5mm (900mm each)	CA410	52		
PINS				
Clevis Pins – Imperial, Zinc Plated. 9 Sizes: 1/4" to 7/16" Dia.	CA52	42		
Roll Pins – Imperial. 12 Sizes: 3/16" to 3/8" Dia. (Large Sizes)	CA1435	58		
Roll Pins – Imperial. 18 Sizes: 1/16" to 1/4" Dia. (Small Sizes)	CA1421	57		
Roll Pins – Imperial. 24 Sizes: 3/32" to 3/8" Dia.	CA2025	74	●	
Roll Pins – Metric. 12 Sizes: 5mm to 10mm Dia. (Large Sizes)	CA1725	60		
Roll Pins – Metric. 18 Sizes: 2mm to 6mm Dia. (Small Sizes)	CA1715	59		
Roll Pins – Metric. 24 Sizes: 2mm to 10mm Dia. (Large Sizes)	CA2020	74	●	

PRODUCT	PART NO.	IMAGE PAGE NO.	MASTER KITS	STAINLESS STEEL
PINS <i>Continued</i>				
Split Pins – Imperial, Zinc Plated. 10 Sizes: 1.6mm to 4mm Dia. incl. 7/64" & 9/64" Dia.	CA800	55		
Split Pins – Metric, Zinc Plated. 11 Sizes: 5mm to 13mm Dia. – Lengths to 150mm (Large Sizes)	CA280	50		
Split Pins – Zinc Plated. 8 Sizes: 1.6mm to 3.2mm Dia. incl. 7/64" Dia.	CA1152	56		
Split Pins – Metric, Zinc Plated. 16 Sizes: 1.6mm x 22mm to 6.3mm x 50mm	CA2540	79	●	
Stainless Steel Roll Pins – Metric, 304/A2. 14 Sizes: 2mm to 6mm Dia.	CA1815	66		●
Stainless Steel Split Pins – Metric, 304/A2. 10 Sizes: 1.6mm to 5mm Dia.	CA1850	67		●
Taper Pins – 14 Sizes: No.4 x 2-1/2" to No.10 x 6" (Large Sizes)	CA1700	59		
Taper Pins – 14 Sizes: No.0 x 1" to No.5 x 2" (Small Sizes)	CA1690	59		
PLUGS				
Expansion Plugs – Cup Type Brass, Imperial. 10 Sizes: 3/4" to 2-1/16"	CA42	42		
Expansion Plugs – Cup Type Brass, Metric. 12 Sizes: 20mm to 50mm	CA43	42		
Expansion Plugs – Cup Type Steel, Imperial, Zinc Plated. 13 Sizes: 19/32" to 2-1/16"	CA38	42		
Expansion Plugs – Cup Type Steel, Zinc Plated, Metric. 12 Sizes: 18mm to 46.5mm	CA1411	56		
Expansion Plugs Steel Disc/Lens Type – Zinc Plated. 16 Sizes: 3/4" to 2"	CA98	44		
Drain (Sump) Plugs Steel – Metric and Imperial, Zinc Plated. 9 Sizes	CA58	43		
RIVETS				
Rivets Blind Aluminium – 10 Sizes: 3/32" to 3/16" Dia.	CA502	53		
Rivet Nut Inserts – 5 Sizes: 4mm to 10mm Dia.	CA505	53		
Rivets Stainless Steel Blind – 304/A2. 16 Sizes: 2.4mm to 5mm Dia.	CA1894	69		●
SCREWS				
Button Head Cap Screws – Metric. 14 Sizes: 4mm to 8mm Dia – Lengths to 30mm	CA1420	57		
Machine Screws & Nuts – Fine Thread Round Head Slotted, Nickel Plated. 11 Sizes: 6/40" to 10/32"	CA228	50		
Machine Screws & Nuts – Metric, Pan Head Phillips, Z/P. 12 Sizes: 3mm to 6mm x 10mm to 25mm Long	CA21	42		
Machine Screws – Metric, Countersunk, Z/P. 13 Sizes: M3 to M6 Dia. – Lengths 16 to 50mm	CA1786	63		
Machine Screws – Metric, Pan Head, Phillips, Zinc Plated. 24 Sizes: M3 to M6 Dia.	CA2705	80	●	
Machine Screws & Nuts – Metric, Countersunk Head, Zinc Plated. 20 Sizes: M3 to M6 Dia.	CA2710	80	●	
Machine Screws & Nuts – Mushroom Head Slotted, UNC, Zinc Plated. 8 Sizes: 3/16" to 1/4"	CA252	50		
Machine Screws & Nuts – Pan Hd, Phillips, 316/A4. 14 Sizes: M5 to M6 Dia. – Lengths 10 to 50mm	CA1888	69		●
Machine Screws & Nuts – C/Sunk, Phillips, 316/A4. 11 Sizes: M5 to M6 Dia. – Lengths 16 to 50mm	CA1890	69		●
Machine Screws & Nuts – Round Head Slotted, BSW, Zinc Plated. 8 Sizes: 1/8" x 3/4" to 1/4" x 2"	CA290	51		
Motorcycle Fasteners – Metric Socket Head Cap, Machine & Hex Screws, & Star Washers, Z/P. 28 Sizes	CA302	51		
Torx® Security Machine Screws – Metric, Pan Head, 304/A2. 14 Sizes: M5 to M8 Dia. – Lengths 10 to 30mm	CA1886	69		●
Torx® Security Machine Screws – Metric, Pan Head, Z/P. 15 Sizes: M4 to M6 Dia. – Lengths 10 to 30mm	CA1772	61		
Torx® Security Machine Screws – Metric, Countersunk, Z/P. 13 Sizes: 4 to 6mm – Lengths 10 to 30mm	CA1774	62		
Torx® Security Button Head Screws – Metric, Zinc Plated. 14 Sizes: M4 to M8 Dia. – Lengths 16 to 30mm	CA1784	62		
Torx® Security Self-Drilling Screws – Pan Head, Zinc Plated. 15 Sizes: 6G to 10G Dia. – Lengths 13 to 38mm	CA1782	62		
Wing Screws – Metric, Zinc Plated. 8 Sizes: M4 to M6 Dia. – Lengths 16mm to 40mm	CA1798	63		

Torx® is a registered trademark of Camcar Textron Inc.

PRODUCT	PART NO.	IMAGE PAGE NO.	MASTER KITS	STAINLESS STEEL
SCREWS <i>Continued</i>				
Sems Assembly – Metric, Single and Double Washers, Zinc Passivated. 20 Sizes: M5 to M10 Dia.	CA2715	80	●	
Socket Head Cap Screws – BSW, High Tensile. 14 Sizes: 3/16" to 5/16" Dia – Lengths to 1-1/2"	CA1418	57		
Socket Head Cap Screws – BSW, High Tensile. 25 Sizes: 3/16" x 5/8" to 1/2" x 2-1/4"	CA2300	78	●	
Socket Head Cap Screws – Metric, High Tensile, GR8.8, 14 Sizes: M5 to M10 Dia.	CA1417	57		
Socket Head Cap Screws Countersunk – Metric, GR8.8, Sizes: 4mm to 8mm Dia – Lengths to 30mm	CA1419	57		
Socket Head Cap Screws – Metric, GR8.8, Zinc Plated. 24 Sizes: 3mm to 8mm Dia.	CA2417	79	●	
Socket Set (Grub) Screws – Metric GR8.8, Imperial. 14 Sizes: 5 to 8mm & 3/16" to 3/8" BSW	CA1416	57		
Stainless Steel (Grub) Screws – Metric & Imperial, 316/A4. 14 Sizes: 5 to 8mm & 3/16" to 3/8" BSW	CA1816	66		●
Stainless Steel Assortment – Bolts, Screws, Washers and Split Pins, 304/A2. 38 Sizes	CA1800	66		●
Stainless Steel Assortment – Screws, Washers and Nuts, 302/A2, 316/A4. 52 Sizes	CA214	215		●
Stainless Steel Cap Screws – Metric, 316/A4. 14 Sizes: 5mm to 10mm	CA1817	66		●
Stainless Steel Cap Screws – BSW, 316/A4. 14 Sizes: 3/16" to 3/8" – Lengths to 1-1/2"	CA1818	66		●
Stainless Steel Machine Screws & Nuts – BSW, 304/A2. 10 Sizes: 1/8" to 1/4"	CA1860	67		●
Stainless Steel Wing Screws & Nuts – Metric, 316/A4. 11 Sizes: M4 to M6 – Lengths 10mm to 25mm	CA1892	69		●
SELF-TAPPING SCREWS				
Anti-Theft One Way Screws – Self-Tapping and 6mm Thread, incl. Washers and Nuts, Zinc Plated	CA570	55		
Self-Drilling Screws – Wafer and Hex Head, Yellow Zinc. 8 Sizes: 8G & 10G – Lengths to 30mm	CA530	54		
Self-Tapping Screws – Pan and Raised Head, Phillips, Black Zinc. 14 Sizes: 6G to 12G – Lengths to 1-1/2"	CA1200	56		
Self-Tapping Screws – Mushroom Head, Black Zinc. 14 Sizes: 6G to 12G – Lengths to 2"	CA1720	60		
Self-Tapping Screws – Pan and Mushroom Head, Phillips, Black Zinc. 28 Sizes: 6G to 12G – Lengths to 2"	CA2045	75	●	
Self-Tapping Screws – Pan and Raised Head, Phillips, N/P. 13 Sizes: 4G to 10G – Lengths to 1-1/2"	CA540	54		
Self-Tapping Screws – Pan and Raised Head, Slotted, Zinc Plated. 13 Sizes: 6G to 12G – Lengths to 1"	CA550	54		
Self-Tapping Screws – Pan Head, Slotted, Zinc Plated. 8 Sizes: 6G to 10G – Lengths to 1-1/2"	CA560	54		
Self-Tapping Screws – Pan Head Phillips, Zinc Plated. 14 Sizes: 6G to 12G – Lengths to 2"	CA1710	59		
Self-Tapping Screws – Raised and Pan Head Slotted, Zinc Plated. 12 Sizes: 6G to 12G – Lengths to 1"	CA420	53		
Self-Tapping Screws – Raised, Hex and Pan Head, Z/P. 14 Sizes: 4G to 14G – Lengths to 1-1/2"	CA430	53		
Self-Tapping Screws – Hex Head, Zinc Plated. 14 Sizes: 6G to 14G – Lengths to 1"	CA350	51		
Self-Tapping Screws – Phillips Raised, Pan Slot & Hex Head, incl. Cup Washers. Z/P, N/P. 19 Sizes: 6G to 14G	CA1630	73	●	
Self-Tapping Screws – Raised C/Sunk, Phillips, 316/A4. 19 Sizes: 4G to 10G Dia. – Lengths 1/2" to 2"	CA1884	68		●
Stainless Steel Self-Tapping Screws – Countersunk, Phillips, 304/A2. 15 Sizes: 4G to 10G – Lengths to 1-1/2"	CA1820	67		●
Stainless Steel Self-Tapping Screws – Pan Head, Phillips, 304/A2. 15 Sizes: 4G to 10G – Lengths 1/2" to 1-1/2"	CA1810	66		●
Torx® Security Self-Tapping Screws – Pan Head, Z/P. 17 Sizes: 6G to 10G Dia. – Lengths 13 to 38mm	CA1776	62		
Torx® Security Self-Tapping Screws – Countersunk, Z/P. 17 Sizes: 6G to 10G Dia. – Lengths 13 to 38mm	CA1778	62		
Torx® Security Self-Tapping Screws – Pan Head, 304/A2. 14 Sizes: 6G to 12G Dia. – Lengths 1/2" to 1-1/2"	CA1882	68		●
SHIM STOCK				
Shim Brass – 150mm x 150mm Sheets. 4 Sizes: .002" to .010" Thickness	CA32	23		
Shim Brass – 60mm Wide Rolls. 5 Sizes: .002" to .010" Thickness	CA31	23		
Shim Steel – 150mm x 150mm Sheets. 4 Sizes: .002" to .010" Thickness	CA34	23		
Shim Steel – 60mm Wide Rolls. 4 Sizes: .002" to .010" Thickness	CA33	23		

Torx® is a registered trademark of Camcar Textron Inc.

PRODUCT	PART NO.	IMAGE PAGE NO.	MASTER KITS	STAINLESS STEEL
SHIM STOCK <i>Continued</i>				
Shim Steel Washers – 14 Sizes: 3/16" to 1" I.D. and .006" Thickness	CA1750	61		
Shim Steel Washers – 36 Sizes: 3/16" to 1-3/8" I.D. and .006" Thickness	CA2276	78	●	
Shim Steel Washers – 22 Sizes: 5/8" to 1-3/8" I.D. and .006" Thickness	CA276	50		
Stainless Steel Shim – 150mm x 150mm Sheets. 4 Sizes: .003" to .027" Thickness	CA36	23		●
SPRINGS				
Accelerator Springs – 9 Sizes: Lengths 4-1/2" to 7" and 3/16" to 7/16" Dia.	CA103	44		
Compression Springs – 12 Sizes: Lengths 1-1/4" to 4" and 3/16" to 3/4" Dia.	CA102	44		
Extension Springs – 12 Sizes: Lengths 1" to 4-3/4" and 3/16" to 1/2" Dia.	CA101	44		
STUDS & NUTS				
Brass Manifold Nuts – UNC, UNF, BSF, Metric Fine and Coarse Pitch. 17 Sizes	CA95	43		
Manifold Studs and Nuts – Metric and UNC. Steel Studs and Nuts, Zinc Passivated. 5 Sizes	CA96	43		
Manifold Studs and Nuts – Metric and Imperial, Steel and Brass, Zinc Passivated. 19 Sizes	CA2096	76	●	
THREAD INSERT REPAIR KIT ASSORTMENTS				
Imperial 3/16 UNC – incl. Tap, Drill Bit, Installation Tool, Break-off Tool and Thread Inserts	CTRK3NC	209		●
Imperial 1/4 UNC – incl. Tap, Drill Bit, Installation Tool, Break-off Tool and Thread Inserts	CTRK4NC	209		●
Imperial 5/16 UNC – incl. Tap, Drill Bit, Installation Tool, Break-off Tool and Thread Inserts	CTRK5NC	209		●
Imperial 3/8 UNC – incl. Tap, Drill Bit, Installation Tool, Break-off Tool and Thread Inserts	CTRK6NC	209		●
Imperial 3/16 UNF – incl. Tap, Drill Bit, Installation Tool, Break-off Tool and Thread Inserts	CTRK3NF	209		●
Imperial 1/4 UNF – incl. Tap, Drill Bit, Installation Tool, Break-off Tool and Thread Inserts	CTRK4NF	209		●
Imperial 5/16 UNF – incl. Tap, Drill Bit, Installation Tool, Break-off Tool and Thread Inserts	CTRK5NF	209		●
Imperial 3/8 UNF – incl. Tap, Drill Bit, Installation Tool, Break-off Tool and Thread Inserts	CTRK6NF	209		●
Metric 5mm x 0.8 – incl. Tap, Drill Bit, Installation Tool, Break-off Tool and Thread Inserts	CTRK508	209		●
Metric 6mm x 1.00 – incl. Tap, Drill Bit, Installation Tool, Break-off Tool and Thread Inserts	CTRK6100	209		●
Metric 8mm x 1.25 – incl. Tap, Drill Bit, Installation Tool, Break-off Tool and Thread Inserts	CTRK8125	209		●
Metric 10mm x 1.50 – incl. Tap, Drill Bit, Installation Tool, Break-off Tool and Thread Inserts	CTRK10150	209		●
Metric 10mm x 1.25 – incl. Tap, Drill Bit, Installation Tool, Break-off Tool and Thread Inserts	CTRK10125	209		●
Metric Size: 5, 6, 8, 10 & 12mm – incl. 5 x Tap Sizes, Insert Tools, Tang Break-off Tools and Drill Bits	CTRKMET-5	209		●
VACUUM HOSE CONNECTORS				
Vacuum Hose and Tube Connectors – 49 Sizes, 136 Pieces	CA2075	76	●	
WASHERS				
Aluminium Washers – Imperial & Metric. 15 Sizes: 1/4" to 1" I.D. & 5 to 20mm I.D. – Thickness: 1/16"	CA1770	61		
Bonded Seal Washers – Imperial. 8 Sizes: 1/8" to 1-1/4" I.D. BSP	CA173	48		
Bonded Seal Washers – Metric. 14 Sizes: Suits 8mm I.D. to 42mm I.D.	CA174	48		
Bonded Seal (Dowty) Washers – Metric & Imperial. 22 Sizes: 8mm to 42mm & 1/8" to 1-1/4" I.D. BSP	CA2173	77	●	
Copper Washers – Metric. 10 Sizes: 5mm to 24mm I.D. – Thickness: 1mm	CA1660	58		
Copper Washers – Imperial. 12 Sizes: 1/4" to 1" I.D. – Thickness: 20G	CA225	49		
Fuel Injection Copper Washers – Metric. 14 Sizes: 6mm to 26mm I.D. – Thickness: 1, 1.5 & 2mm	CA226	49		
Fuel Injection Copper Washers – Metric. 24 Sizes: 5mm to 26mm I.D. – Thickness: 1, 1.5 & 2mm	CA2260	78	●	

PRODUCT	PART NO.	IMAGE PAGE NO.	MASTER KITS	STAINLESS STEEL
WASHERS <i>Continued</i>				
Drain (Sump) Plug Washers – Fibre, Aluminium & Copper Crush Metric. 12 Sizes: 12mm to 25mm I.D.	CA140	47		
Drain (Sump) Plug Washers – Fibre, Aluminium & Copper Crush Metric. 25 Sizes: 12mm to 25mm I.D.	CA2140	76	●	
Drain (Sump) Plug Washers – Aluminium Met & Imp. 8 Sizes: 12-24mm I.D. & 1/2" I.D. – Thickness: 2.5mm	CA1790	63		
Drain (Sump) Plug Washers – Fibre, Met & Imp. 10 Sizes: 1/2" to 1" & 18-30mm I.D. – Thickness: 3/32"	CA150	48		
Nylon Washers – Metric and Imperial. 11 Sizes: 12mm to 25mm & 1/2" to 13/16" I.D.	CA1740	60		
Polypropylene Washers – 10 Sizes: 18mm to 30mm & 1/2" to 1" I.D. – Thickness: 3mm	CA1460	58		
Fibre Washers – 14 Sizes: 1/8" to 1" I.D. – Thickness: 1/32"	CA825	55		
Fibre Washers – 36 Sizes: 5/32" to 1" & 14mm to 30mm I.D. – Thickness: 1/32", 1/16", 3/32"	CA2060	75	●	
Fibre Washers – 12 Sizes: 5/32" to 3/4" I.D. – Thickness: 1/16"	CA390	52		
Fibre Washers – 14 Sizes: 1/8" to 1" I.D. – Thickness: 1/32"	CA400	52		
Flat and Body Steel Washers – Imperial and Metric, Z/P. 20 Sizes: 1/8" to 1" & 6mm to 12mm I.D.	CA2240	78	●	
Flat and Spring Steel Washers – Imperial and Metric, Z/P. 25 Sizes: 5/32" to 3/4" & 6mm to 20mm I.D.	CA2050	75	●	
Flat Steel Heavy Duty Washers – Imperial, Zinc Plated. 8 Sizes: 3/16" to 3/4" I.D. – Thickness: 14G	CA600	55		
Flat Steel Washers – Imperial and Metric, Zinc Plated. 13 Sizes: 3/16" to 3/4" & 6mm to 20mm I.D.	CA576	55		
Flat Steel Washers – Imperial, High Tensile, Zinc Plated. 10 Sizes: 1/4" to 1" I.D.	CA1755	61		
Flat Steel Washers – Imperial and Metric, Zinc Plated. 10 Sizes: 3/16" to 3/4" & M10 I.D.	CA330	51		
Flat Washers, Extra Heavy Duty – Imperial, Z/P. 8 Sizes: 3/16" to 3/4" I.D. – Thickness: up to 9G	CA1670	58		
Panel (Body) Washers – Panel (Body) Steel and Stainless Steel, Zinc Plated. 8 Sizes: 3/16" to 1/2" I.D.	CA1730	60		
Polypropylene Washers – Imperial. 16 Sizes: 1/8" to 1" I.D. – Thickness: 1/32"	CA1680	59		
Shim Steel Washers – 14 Sizes: 3/16" to 1" I.D. – Thickness .006"	CA1750	61		
Shim Steel Washers – 36 Sizes: 3/16" to 1-3/8" I.D. – Thickness .006"	CA2276	78	●	
Shim Steel Washers – 22 Sizes: 5/8" to 1-3/8" I.D. – Thickness .006"	CA276	50		
Spacing Washers Steel – Imperial. 14 Sizes: 1/4" to 1-1/8" I.D. – Thickness: 22G (.028")	CA500	53		
Spring Washers – Imperial and Metric, Zinc Plated. 11 Sizes: 5/32" to 3/4" & M4 to M16 I.D.	CA520	54		
Spring Washers – Imperial and Metric, Zinc Plated. 12 Sizes: 5/32" to 5/8" & 4mm to 20mm I.D.	CA648	55		
Spring Washers – Square Section, Zinc Plated, Imperial. 8 Sizes: 3/16" to 3/4" I.D.	CA1008	56		
Stainless Steel Flat and Panel Washers – 304/A2. 16 Sizes: 1/8" to 3/4" I.D.	CA1830	67		●
Stainless Steel Spring Washers – 304/A2, Imperial. 12 Sizes: 5/32" to 3/4" & 4mm to 16mm I.D.	CA1840	67		●
Star Washers – Internal and External, Zinc Plated. 14 Sizes: 3/16" to 5/8"	CA510	54		
Star Washers – Internal and External, Zinc Plated. 14 Sizes: 4mm to 16mm	CA1780	62		
WIRING TERMINALS				
Wiring Connector Block – M/F with Brass Terminals. 4 Sizes: 2, 4, 6 & 8 Pin	CA240	50		
Wiring Terminals – Crimp Type incl. Adjustable Ratchet Crimp Tool. Suits: 3, 4 & 5mm Wire. 20 Types	CA2700	79	●	
Wiring Terminals – Crimp Type. 28 Types incl. Push-On Bullet, Ring, Tab, Splice and Lanced	CA2040	75	●	
Wiring Terminals – Insulated Crimp Type. 14 Types incl. Spade, Ring, Tab and Splice	CA161	48		
WOODRUFF KEYS				
Woodruff Keys – Imperial. 17 Sizes: No.2 to No.'E' (3/32" to 3/8")	CA177	48		
Woodruff Keys – Imperial and Metric. 34 Sizes: 3/32" to 3/8" & 2mm to 10mm Dia.	CA2177	77	●	
Woodruff Keys – Metric. 17 Sizes: 2mm x 10mm to 10mm x 32mm	CA1705	59		

ASSORTMENTS – CHAMPION RED CASES

PART NO.	IMAGE PAGE NO.	ASSORTMENTS
CA21	42	Machine Screws and Nuts – Metric, Pan Head Phillips, Z/P. 12 Sizes: 3mm to 6mm x 10mm to 25mm Long
CA22	42	Pipe Support Anchors – Metal with Rubber Protector. 28 Pieces
CA38	42	Expansion Plugs – Cup Type Steel, Imperial, Zinc Plated. 13 Sizes: 19/32" to 2-1/16"
CA42	42	Expansion Plugs – Cup Type Brass, Imperial. 10 Sizes: 3/4" to 2-1/16"
CA43	42	Expansion Plugs – Cup Type Brass, Metric. 12 Sizes: 20mm to 50mm
CA52	42	Clevis Pins – Imperial, Zinc Plated. 9 Sizes: 1/4" to 7/16" Dia.
CA58	43	Drain (Sump) Plugs Steel – Metric and Imperial, Zinc Plated. 9 Sizes
CA63	43	Wiring Grommets – Rubber. 12 Sizes: 1/8" to 29/32" (Wire Hole Size)
CA70	43	Brass Fittings – Adaptors, Tails, Elbows, Nuts and Connectors. 20 Types
CA90	43	Blanking Grommets – Rubber. 8 Sizes: 5/16" to 1-1/8" (Panel Hole Size)
CA95	43	Brass Manifold Nuts – UNC, UNF, BSF, Metric Fine and Coarse Pitch. 17 Sizes
CA96	43	Manifold Studs and Nuts – Metric and UNC. Steel Studs and Nuts, Zinc Passivated. 5 Sizes
CA98	44	Expansion Plugs Steel Disc/Lens Type – Zinc Plated. 16 Sizes: 3/4" to 2"
CA100	44	Flange Nuts – Zinc Plated. 8 Sizes: 5mm to 12mm, incl. M10 to M12 x 1.25 Fine Pitch
CA101	44	Extension Springs – 12 Sizes: Lengths 1" to 4-3/4" and 3/16" to 1/2" Dia.
CA102	44	Compression Springs – 12 Sizes: Lengths 1-1/4" to 4" and 3/16" to 3/4" Dia.
CA103	44	Accelerator Springs – 9 Sizes: Lengths 4-1/2" to 7" and 3/16" to 7/16" Dia.
CA105	44	Fuses – Glass, Blade and European. 14 Sizes: 3 Amp. to 35 Amp.
CA106	45	Wheel Alignment Shims – Imperial. 12 Sizes for GM & Ford vehicles, 4 Types in 1/32", 1/16" & 1/8" Thickness. 131 Pieces
CA107	45	Wheel Alignment Shims – Metric. 11 Sizes. Thickness: 1, 1.5, 2 & 3mm. 100 Pieces
CA108	45	Grease Nipples – Straight and Angle Nipples. UNF, BSF, BSP and NPT Threads. 15 Sizes
CA109	45	Grease Nipples – Straight and Angle Nipples. Metric, Fine and Coarse. 12 Sizes: 6mm to 10mm Dia.
CA110	45	Fuses – AF Blade. 8 Sizes: 3, 5, 7.5, 10, 15, 20, 25 & 30 Amp.
CA111	45	Fuses – Low Profile Blade. 8 Sizes: 3, 5, 7.5, 10, 15, 20, 25 & 30 Amp.
CA112	46	Fuses – Mini Blade. 8 Sizes: 3, 5, 7.5, 10, 15, 20, 25 & 30 Amp.
CA113	46	Fuses – AF Circuit Breaker. 7 Sizes: 5, 7.5, 10, 15, 20, 25, 30 Amp.

PART NO.	IMAGE PAGE NO.	ASSORTMENTS
CA115	46	Imperial 'O' Rings – Nitrile, 70 Shore. 14 Sizes: 3/16" to 1" I.D.
CA116	46	Metric 'O' Rings – Nitrile, 70 Shore. 15 Sizes: 5mm to 25mm I.D.
CA118	46	High Temp and High Pressure 'O' Rings – Viton, Imperial, 75 Shore. 12 Sizes: 7/32" to 1"
CA120	46	UNF Set Screws with Nuts – High Tensile, GR5, Zinc Plated. 11 Sizes: 1/4" to 3/8" Dia.
CA124	47	Nylon Cable 'P' Clamps and Cable Tie Mounts – 124 Pieces
CA125	47	UNC Set Screws and Nuts – High Tensile, GR5, Zinc Plated. 11 Sizes: 1/4" to 3/8" Dia.
CA126	47	Self-Locking Nuts, Nylon Insert – UNC and UNF, Zinc Plated. 12 Sizes: 3/16" to 1/2"
CA132	47	Brass Fittings – Olives, Unions, Flare Nuts and Reducing Bushes. 33 Types
CA134	47	Brass Fittings – Single and Double Unions, Nuts and Elbows. 22 Types
CA140	47	Drain (Sump) Plug Washers – Fibre, Aluminium and Copper Crush Metric. 12 Sizes: 12mm to 25mm I.D.
CA150	48	Drain (Sump) Plug Washers – Fibre, Metric & Imperial. 10 Sizes: 1/2" to 1" & 18mm to 30mm I.D. – Thickness: 3/32"
CA155	48	Circlips – Imperial, Internal and External. 14 Sizes: 1/4" to 1"
CA161	48	Wiring Terminals – Insulated Crimp Type. 14 Types incl. Spade, Ring, Tab and Splice
CA173	48	Bonded Seal Washers – Imperial. 8 Sizes: 1/8" to 1-1/4" I.D. BSP
CA174	48	Bonded Seal Washers – Metric. 14 Sizes: Suits 8mm I.D. to 42mm I.D.
CA177	48	Woodruff Keys – Imperial. 17 Sizes: No.2 to No.'E' (3/32" to 3/8")
CA178	49	Brass Fittings – Single and Double Unions, Dole Nuts, M/F Elbows, Nipples and Plugs
CA196	49	Set Screws and Nuts – Metric, High Tensile, GR8.8, Zinc Plated. 13 Sizes: M4 to M10 Dia.
CA200	49	Flange Head Hex Set Screws and Nuts – Metric J.I.S, High Tensile, GR8.8, Zinc Plated. 14 Sizes: 5 to 10mm
CA212	49	High Pressure Series 'O' Rings – Nitrile, Imperial, 90 Shore. 20 Sizes: 3/16" to 2" with Removing Tool
CA225	49	Copper Washers – Imperial. 12 Sizes: 1/4" to 1" I.D. – Thickness: 20G
CA226	49	Fuel Injection Copper Washers – Metric. 14 Sizes: 6mm to 26mm I.D. – Thickness: 1, 1.5 & 2mm
CA228	50	Machine Screws and Nuts – Fine Thread Round Head Slotted, Nickel Plated. 11 Sizes: 6/40" to 10/32"
CA240	50	Wiring Connector Block – M/F with Brass Terminals. 4 Sizes: 2, 4, 6 & 8 Pin
CA252	50	Machine Screws and Nuts – Mushroom Head Slotted, UNC, Zinc Plated. 8 Sizes: 3/16" to 1/4"
CA270	50	Self-Locking Nuts, Nylon Insert – Metric, Zinc Plated. 10 Sizes: M5 x 0.8 to M12 x 1.75
CA276	50	Shim Steel Washers – 22 Sizes: 5/8" to 1-3/8" I.D. – Thickness .006"
CA280	50	Split Pins – Metric, Zinc Plated. 11 Sizes: 5mm to 13mm Dia. Lengths to 150mm (Large Sizes)
CA290	51	Machine Screws and Nuts – Round Head Slotted, BSW, Zinc Plated. 8 Sizes: 1/8" x 3/4" to 1/4" x 2"
CA300	51	Hex Nuts – Metric, Zinc Plated. 12 Sizes: Plain Nuts M3 to M10, Self-Locking Nuts M4 to M10
CA302	51	Motorcycle Fasteners – Metric Socket Head Cap, Machine and Hex Screws, Nuts and Star Washers, Z/P. 28 Sizes

PART NO.	IMAGE PAGE NO.	ASSORTMENTS
CA330	51	Flat Steel Washers – Imperial and Metric, Zinc Plated. 10 Sizes: 3/16" to 3/4" & M10 I.D.
CA350	51	Self-Tapping Screws – Hex Head, Zinc Plated. 14 Sizes: 6G to 14G – Lengths to 1"
CA360	51	Self-Locking Nuts, Nylon Insert – Metric, UNC, UNF and Zinc Plated. 10 Sizes: M6 to M10 & 1/4" to 3/8"
CA380	52	Speed Nuts – 'U' and Flat Types, Zinc Passivated. 12 Sizes: 3/32" to 3/16" Dia.
CA390	52	Fibre Washers – 12 Sizes: 5/32" to 3/4" I.D. – Thickness: 1/16"
CA400	52	Fibre Washers – 14 Sizes: 1/8" to 1" I.D. – Thickness: 1/32"
CA407	52	Imperial 'O' Rings – Nitrile, 70 Shore. 32 Sizes: 1/8" to 2" I.D.
CA408	52	Metric 'O' Rings – Nitrile, 70 Shore. 32 Sizes: 3mm to 50mm I.D.
CA409	52	'O' Ring Splicing Kit – Nitrile, Imperial, 70 Shore. 5 Sizes: 'O' Ring Cord .070" to .275" (36" each)
CA410	52	'O' Ring Splicing Kit – Nitrile, Metric, 70 Shore. 9 Sizes: 'O' Ring Cord 1.5mm to 8.5mm (900mm each)
CA411	53	Air Conditioning 'O' Rings – Suits R134A Gas. HMBR (Green), Imperial, 70 Shore. 10 Sizes: 3/16" to 3/4"
CA420	53	Self-Tapping Screws – Raised and Pan Head Slotted, Zinc Plated. 12 Sizes: 6G to 12G – Lengths to 1"
CA430	53	Self-Tapping Screws – Raised, Hex and Pan Head, Zinc Plated. 14 Sizes: 4G to 14G – Lengths to 1-1/2"
CA500	53	Spacing Washers Steel – Imperial. 14 Sizes: 1/4" to 1-1/8" I.D. – Thickness: 22G (.028")
CA502	53	Rivets Blind Aluminium – 10 Sizes: 3/32" to 3/16" Dia.
CA505	53	Rivet Nut Inserts – 5 Sizes: 4mm to 10mm Dia.
CA510	54	Star Washers – Internal and External, Zinc Plated. 14 Sizes: 3/16" to 5/8"
CA520	54	Spring Washers – Imperial and Metric, Zinc Plated. 11 Sizes: 5/32" to 3/4" & M4 to M16 I.D.
CA530	54	Self Drilling Screws – Wafer and Hex Head, Yellow Zinc. 8 Sizes: 8G & 10G – Lengths to 30mm
CA540	54	Self-Tapping Screws – Pan and Raised Head, Phillips, Nickel Plated. 13 Sizes: 4G to 10G – Lengths to 1-1/2"
CA550	54	Self-Tapping Screws – Pan and Raised Head, Slotted, Zinc Plated. 13 Sizes: 6G to 12G – Lengths to 1"
CA560	54	Self-Tapping Screws – Pan Head, Slotted, Zinc Plated. 8 Sizes: 6G to 10G – Lengths to 1-1/2"
CA570	55	Anti-Theft One Way Screws – Self-Tapping and 6mm Thread, incl. Washers and Nuts, Zinc Plated
CA576	55	Flat Steel Washers – Imperial and Metric, Zinc Plated. 13 Sizes: 3/16" to 3/4" & 6mm to 20mm I.D.
CA600	55	Flat Steel Heavy Duty Washers – Imperial, Zinc Plated. 8 Sizes: 3/16" to 3/4" I.D. – Thickness: 14G
CA648	55	Spring Washers – Imperial and Metric, Zinc Plated. 12 Sizes: 5/32" to 5/8" & 4mm to 20mm I.D.
CA800	55	Split Pins – Imperial, Zinc Plated. 10 Sizes: 1.6mm to 4mm Dia. incl. 7/64" & 9/64" Dia.
CA825	55	Fibre Washers – 14 Sizes: 1/8" to 1" I.D. – Thickness: 1/32"
CA1008	56	Spring Washers – Square Section, Zinc Plated, Imperial. 8 Sizes: 3/16" to 3/4" I.D.
CA1152	56	Split Pins – Zinc Plated. 8 Sizes: 1.6mm to 3.2mm Dia. incl. 7/64" Dia.
CA1200	56	Self-Tapping Screws – Pan and Raised Head, Phillips, Black Zinc. 14 Sizes: 6G to 12G – Lengths to 1-1/2"
CA1320	56	Linkages (Ball Joints) – 90° and Inline, Zinc Plated. 10 Sizes: 3/16" to 5/16"
CA1411	56	Expansion Plugs – Cup Type Steel, Zinc Plated, Metric. 12 Sizes: 18mm to 46.5mm
CA1412	56	Brass Olives – Suits Copper and Nylon Tube. Sizes: Copper 1/8" to 1/2" and Nylon 3/16" to 3/8", 330 Pieces
CA1416	57	Socket Set (Grub) Screws – Metric GR8.8 and Imperial. 14 Sizes: 5mm to 8mm & 3/16" to 3/8" BSW
CA1417	57	Socket Head Cap Screws – Metric, High Tensile, GR8.8, 14 Sizes: M5 to M10 Dia.
CA1418	57	Socket Head Cap Screws – BSW, High Tensile, 14 Sizes: 3/16" to 5/16" Dia. – Lengths to 1-1/2"
CA1419	57	Socket Head Cap Screws Countersunk – Metric, GR8.8, Sizes: 4mm to 8mm Dia. – Lengths to 30mm

PART NO.	IMAGE PAGE NO.	ASSORTMENTS
CA1420	57	Button Head Cap Screws – Metric, High Tensile. 14 sizes: 4mm to 8mm Dia. – Lengths to 30mm
CA1421	57	Roll Pins – Imperial. 18 Sizes: 1/16" to 1/4" Dia. (Small Sizes)
CA1424	58	'E' Clips and Retainer Springs – 14 Sizes: 3/32" to 5/8"
CA1435	58	Roll Pins – Imperial. 12 Sizes: 3/16" to 3/8" Dia. (Large Sizes)
CA1460	58	Polypropylene Washers – 10 Sizes: 18mm to 30mm & 1/2" to 1" I.D. – Thickness: 3mm
CA1480	58	Hex Set Screws and Nuts – Metric GR8.8, ISO and Fine Pitch, Zinc Plated. 9 Sizes: M6 to M12 Dia.
CA1660	58	Copper Washers – Metric. 10 Sizes: 5mm to 24mm I.D. – Thickness: 1mm
CA1670	58	Flat Washers, Extra Heavy Duty – Imperial, Zinc Plated. 8 Sizes: 3/16" to 3/4" I.D. – Thickness: up to 9G
CA1680	59	Polypropylene Washers – Imperial. 16 Sizes: 1/8" to 1" I.D. – Thickness: 1/32"
CA1690	59	Taper Pins – 14 Sizes: No.0 x 1" to No.5 x 2" (Small Sizes)
CA1700	59	Taper Pins – 14 Sizes: No.4 x 2-1/2" to No.10 x 6" (Large Sizes)
CA1705	59	Woodruff Keys – Metric. 17 Sizes: 2mm x 10mm to 10mm x 32mm
CA1710	59	Self-Tapping Screws – Pan Head Phillips, Zinc Plated. 14 Sizes: 6G to 12G – Lengths to 2"
CA1715	59	Roll Pins – Metric. 18 Sizes: 2mm to 6mm Dia. (Small Sizes)
CA1720	60	Self-Tapping Screws – Mushroom Head, Black Zinc. 14 Sizes: 6G to 12G – Lengths to 2"
CA1725	60	Roll Pins – Metric. 12 Sizes: 5mm to 10mm Dia. (Large Sizes)
CA1730	60	Panel (Body) Washers – Panel (Body) Steel and Stainless Steel, Zinc Plated. 8 Sizes: 3/16" to 1/2" I.D.
CA1735	60	Plastic Trim Clips and Screw Grommets – 14 Sizes, 180 Pieces
CA1740	60	Nylon Washers – Metric and Imperial. 11 Sizes: 12mm to 25mm & 1/2" to 13/16" I.D.
CA1745	60	'R' Clips – Zinc Plated. 8 Sizes: 1/8" to 1" (Shaft Size)
CA1750	61	Shim Steel Washers – 14 Sizes: 3/16" to 1" I.D. – Thickness .006"
CA1755	61	Flat Steel Washers – Imperial, High Tensile, Zinc Plated. 10 Sizes: 1/4" to 1" I.D.
CA1760	61	Circlips – Metric Internal and External. 14 Sizes: 6mm to 25mm
CA1765	61	Lock Rings – External SPN Type. 10 Sizes: 1.5mm to 12mm
CA1770	61	Aluminium Washers – Imperial and Metric. 15 Sizes: 1/4" to 1" I.D. & 5mm to 20mm I.D. – Thickness: 1/16"
CA1772	61	Torx® Security Machine Screws – Metric, Pan Head, Zinc Plated. 15 Sizes: M4 to M6 Dia. – Lengths 10 to 30mm
CA1774	62	Torx® Security Machine Screws – Metric, Countersunk, Z/P. 13 Sizes: 4mm to 6mm – Lengths 10mm to 30mm
CA1776	62	Torx® Security Self-Tapping Screws – Pan Head, Zinc Plated. 17 Sizes: 6G to 10G Dia. – Lengths 13mm to 38mm
CA1778	62	Torx® Security Self-Tapping Screws – Countersunk, Zinc Plated. 17 Sizes: 6G to 10G Dia. – Lengths 13mm to 38mm
CA1780	62	Star Washers – Internal and External, Zinc Plated. 14 Sizes: 4mm to 16mm
CA1782	62	Torx® Security Self-Drilling Screws – Pan Head, Zinc Plated. 15 Sizes: 6G to 10G Dia. – Lengths 13mm to 38mm
CA1784	62	Torx® Security Button Head Screws – Metric, Zinc Plated. 14 Sizes: M4 to M8 Dia. – Lengths 16mm to 30mm
CA1786	63	Machine Screws – Metric, Countersunk, Zinc Plated. 13 Sizes: M3 to M6 Dia. – Lengths 16mm to 50mm
CA1790	63	Drain (Sump) Plug Washers – Aluminium, Metric & Imperial. 8 Sizes: 12 to 24mm I.D. & 1/2" I.D. – Thickness: 2.5mm
CA1792	63	Nylon Nuts – Metric, Wing, Dome and Hex Nuts. 9 Sizes: M5 to M8 Dia. & 5mm to 8mm
CA1794	63	Wing Nuts – Metric and UNC, Zinc Plated. 9 Sizes: M4 to M10, UNC 3/16" to 3/8"
CA1796	63	Coupling Nuts – Metric and UNC, Zinc Plated. 10 Sizes: M5 to M12 & 3/16" to 7/16"
CA1798	63	Wing Screws – Metric, Zinc Plated. 8 Sizes: M4 to M6 Dia. – Lengths 16mm to 40mm

Torx® is a registered trademark of Camcar Textron Inc.



CA21 MACHINE SCREWS & NUTS

- Metric, Pan Head Phillips, Zinc Plated.
- 12 Sizes: 3mm to 6mm x 10mm to 25mm Long • 520 Pieces

Replacement Packs: Page 82 (C21-1 to C21-16)



CA22 PIPE SUPPORT ANCHORS

- Metal with Rubber Protector
- 28 Pieces

Replacement Packs: Page 82 (C22-1 to C22-6)



CA38 EXPANSION PLUGS

- Cup Type Steel, Imperial, Zinc Plated.
- 13 Sizes: 19/32" to 2-1/16" • 52 Pieces

Replacement Packs: Page 82 (C38-1 to C38-13)



CA42 EXPANSION PLUGS

- Cup Type Brass, Imperial.
- 10 Sizes: 3/4" to 2-1/16" • 35 Pieces

Replacement Packs: Page 82 (C42-1 to C42-10)



CA43 EXPANSION PLUGS

- Cup Type Brass, Metric.
- 12 Sizes: 20mm to 50mm • 42 Pieces

Replacement Packs: Page 82 (C43-1 to C43-12)



CA52 CLEVIS PINS

- Imperial, Zinc Plated.
- 9 Sizes: 1/4" to 7/16" Dia. • 52 Pieces

Replacement Packs: Page 82 (C52-1 to C52-9)



CA58 DRAIN (SUMP) PLUGS STEEL

- Metric and Imperial, Zinc Plated.
- 9 Sizes • 58 Pieces

Replacement Packs are not available. Refer to page 82 for refills.



CA63 WIRING GROMMETS

- Rubber
- 12 Sizes: 1/8" to 29/32" (Wire Hole Size) • 83 Pieces

Replacement Packs: Page 82 (C63-1 to C63-12)



CA70 BRASS FITTINGS

- Adaptors, Tails, Elbows, Nuts and Connectors.
- 20 Types • 59 Pieces

Replacement Packs are not available. Refer to page 83 for refills.



CA90 BLANKING GROMMETS

- Rubber
- 8 Sizes: 5/16" to 1-1/8" (Panel Hole Size) • 91 Pieces

Replacement Packs: Page 83 (C90-1 to C90-8)



CA95 BRASS MANIFOLD NUTS

- UNC, UNF, BSF, Metric Fine and Coarse Pitch.
- 17 Sizes • 83 Pieces

Replacement Packs: Page 83 (C95-1 to C95-17)



CA96 MANIFOLD STUDS & NUTS

- Metric and UNC. Steel Studs and Nuts, Zinc Passivated.
- 5 Sizes • 96 Pieces

Replacement Packs: Page 83 (C96-1 to C96-15)



CA98 EXPANSION PLUGS STEEL

- Disc/Lens Type, Zinc Plated.
- 16 Sizes: 3/4" to 2" • 100 Pieces

Replacement Packs: Page 83 (C98-1 to C98-16)



CA100 FLANGE NUTS

- Zinc Plated
- 8 Sizes: 5mm to 12mm, incl. M10 to M12 Fine Pitch • 140 Pieces

Replacement Packs: Page 83 (C100-1 to C100-7)



CA101 EXTENSION SPRINGS

- Plain Finish
- 12 Sizes: Lengths 1" to 4-3/4" and 3/16" to 1/2" Dia. • 48 Pieces

Replacement Packs: Page 83 (C101-25 to C101-36)



CA102 COMPRESSION SPRINGS

- Plain Finish
- 12 Sizes: Lengths 1-1/4" to 4" and 3/16" to 3/4" Dia. • 72 Pieces

Replacement Packs: Page 84 (C102-25 to C102-36)



CA103 ACCELERATOR SPRINGS

- Plain Finish
- 9 Sizes: Lengths 4-1/2" to 7" and 3/16" to 7/16" Dia. • 36 Pieces

Replacement Packs: Page 84 (C103-1 to C103-9)



CA105 FUSES

- Glass, Blade and European. • 100 Pieces
- 14 Sizes: Glass 3-35 Amp. Blade 10-20 Amp. European 8-25 Amp.

Replacement Packs: Page 84 (C105-1 to C105-16)



CA106 WHEEL ALIGNMENT SHIMS

- Imperial • Suitable for GM and Ford Vehicles
 - 12 Sizes: 4 Types in 1/32", 1/16" & 1/8" Thickness • 131 Pieces
- Replacement Packs: Page 84 (C106-1 to C106-12)



CA107 WHEEL ALIGNMENT SHIMS

- Metric
 - 11 Sizes: 1, 1.5, 2 & 3mm Thickness • 100 Pieces
- Replacement Packs: Page 84 (C107-1 to C107-11)



CA108 GREASE NIPPLES

- Straight and Angle Nipples. UNF, BSF, BSP and NPT Threads.
 - 15 Sizes • 113 Pieces
- Replacement Packs: Page 84 (C108-1 to C108-17)



CA109 GREASE NIPPLES

- Straight and Angle Nipples. Metric, Fine and Coarse.
 - 12 Sizes: 6mm to 10mm Dia. • 105 Pieces
- Replacement Packs: Page 84 (C109-1 to C109-14)



CA110 FUSES

- AF Blade
 - 8 Sizes: 3, 5, 7.5, 10, 15, 20, 25 & 30 Amp. • 110 Pieces
- Replacement Packs: Page 84 (C110-1 to C110-8)



CA111 FUSES

- Low Profile Blade
 - 8 Sizes: 3, 5, 7.5, 10, 15, 20, 25 & 30 Amp. • 120 Pieces
- Replacement Packs: Page 85 (C111-1 to C111-8)



CA112 FUSES

- Mini Blade
 - 8 Sizes: 3, 5, 7.5, 10, 15, 20, 25 & 30 Amp. • 120 Pieces
- Replacement Packs: Page 85 (C112-1 to C112-8)

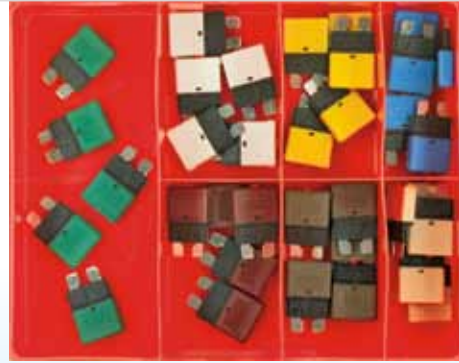

CA113 FUSES

- AF Circuit Breaker
 - 7 Sizes: 5, 7.5, 10, 15, 20, 25, 30 Amp. • 35 Pieces
- Replacement Packs: Page 85 (C113-1 to C113-7)



CA115 'O' RINGS

- Imperial, Nitrile, 70 Shore
 - 14 Sizes: 3/16" to 1" I.D. • 115 Pieces
- Replacement Packs: Page 85 (C115-1 to C115-14)



CA116 'O' RINGS

- Metric, Nitrile, 70 Shore
 - 15 Sizes: 5mm to 25mm I.D. • 130 Pieces
- Replacement Packs: Page 85 (C116-1 to C116-15)

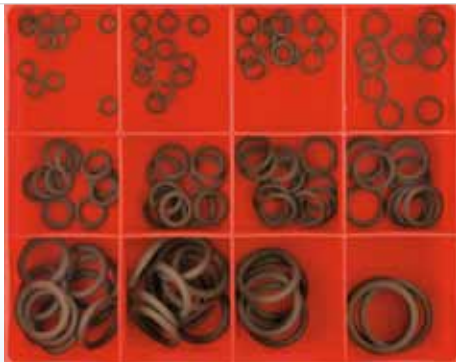

CA118 'O' RINGS

- High Temp and High Pressure. Viton, Imperial, 75 Shore.
 - 12 Sizes: 7/32" to 1" • 110 Pieces
- Replacement Packs: Page 85 (C118-1 to C118-12)



CA120 UNF SET SCREWS & NUTS

- High Tensile, GR5, Zinc Plated.
 - 11 Sizes: 1/4" to 3/8" Dia. • 113 Pieces
- Replacement Packs: Page 85 (C120-1 to C120-14)



CA124 'P' CLAMPS & CABLE TIE MOUNTS

- Nylon Cable 'P' Clamps and Cable Tie Mounts
- 124 Pieces

Replacement Packs: Page 86 (C124-1 to C124-8)



CA125 UNC SET SCREWS & NUTS

- High Tensile, GR5, Zinc Plated
- 11 Sizes: 1/4" to 3/8" Dia. • 113 Pieces

Replacement Packs: Page 86 (C125-1 to C125-14)



CA126 SELF-LOCKING NUTS

- Nylon Insert – UNC and UNF, Zinc Plated.
- 12 Sizes: 3/16" to 1/2" • 131 Pieces

Replacement Packs: Page 86 (C126-1 to C126-12)



CA132 BRASS FITTINGS

- Olives, Unions, Flare Nuts and Reducing Bushes.
- 33 Types • 111 Pieces

Replacement Packs are not available. Refer to page 86 for refills.



CA134 BRASS FITTINGS

- Single and Double Unions, Nuts and Elbows.
- 22 Types • 110 Pieces

Replacement Packs are not available. Refer to page 86 for refills.



CA140 DRAIN (SUMP) PLUG WASHERS

- Fibre, Aluminium and Copper Crush Metric.
- 12 Sizes: 12mm to 25mm I.D. • 102 Pieces

Replacement Packs: Page 86/87 (C140-1 to C140-12)



CA150 DRAIN (SUMP) PLUG WASHERS

- Fibre, Metric & Imperial. • 10 Sizes: 1/2" to 1" & 18 to 30mm I.D.
- Thickness: 3/32" • 143 Pieces

Replacement Packs: Page 87 (C150-1 to C150-11)



CA155 CIRCLIPS

- Imperial, Internal and External.
- 14 Sizes: 1/4" to 1" • 155 Pieces

Replacement Packs: Page 87 (C155-1 to C155-14)



CA161 WIRING TERMINALS

- Insulated Crimp Type
- 14 Types incl. Spade, Ring, Tab and Splice • 136 Pieces

Replacement Packs: Page 87 (C161-1 to C161-14)



CA173 BONDED SEAL WASHERS

- Imperial
- 8 Sizes: 1/8" to 1-1/4" I.D. BSP • 82 Pieces

Replacement Packs are not available. Refer to page 132 for refills.



CA174 BONDED SEAL WASHERS

- Metric
- 14 Sizes: Suits 8mm I.D. to 42mm I.D. • 91 Pieces

Replacement Packs are not available. Refer to page 132 for refills.



CA177 WOODRUFF KEYS

- Imperial
- 17 Sizes: No.2 to No.'E' (3/32" to 3/8") • 177 Pieces

Replacement Packs: Page 87 (C177-1 to C177-17)



CA178 BRASS FITTINGS

- Single & Double Unions, Dole Nuts, M/F Elbows, Nipples & Plugs
- 32 Types • 155 Pieces

Replacement Packs are not available. Refer to page 87 for refills.



CA196 SET SCREWS & NUTS

- Metric, High Tensile, GR8.8, Zinc Plated.
- 13 Sizes: M4 to M10 Dia. • 221 Pieces

Replacement Packs: Page 88 (C196-1 to C196-17)



CA200 FLANGE HD HEX SET SCREWS & NUTS

- Metric J.I.S, High Tensile, GR8.8, Zinc Plated.
- 14 Sizes: 5mm to 10mm • 202 Pieces

Replacement Packs are not available. Refer to page 145 for refills.

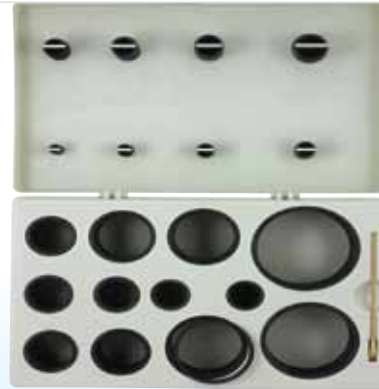

CA212 'O' RINGS

- High Pressure Series. Nitrile, Imperial, 90 Shore.
- 20 Sizes: 3/16" to 2" with Removing Tool • 212 Pieces

Replacement Packs: Page 88 (C212-1 to C212-32)



CA225 COPPER WASHERS

- Imperial
- 12 Sizes: 1/4" to 1" I.D. • Thickness: 20G • 260 Pieces

Replacement Packs: Page 88 (C225-1 to C225-12)



CA226 FUEL INJECTION COPPER WASHERS

- Metric • 14 Sizes: 6mm to 26mm I.D.
- Thickness: 1, 1.5 & 2mm • 305 Pieces

Replacement Packs: Page 88 (C226-1 to C226-14)



CA228 MACHINE SCREWS & NUTS

- Fine Thread Round Head Slotted, Nickel Plated.
- 11 Sizes: 6/40" to 10/32" • 300 Pieces

Replacement Packs: Page 89 (C228-1 to C228-14)



CA240 WIRING CONNECTOR BLOCK

- M/F with Brass Terminals
- 4 Sizes: 2, 4, 6 & 8 Pin • 240 Pieces

Replacement Packs: Page 89 (C240-1 to C240-10)



CA252 MACHINE SCREWS & NUTS

- Mushroom Head Slotted, UNC, Zinc Plated.
- 8 Sizes: 3/16" to 1/4" • 300 Pieces

Replacement Packs: Page 89 (C252-1 to C252-10)



CA270 SELF-LOCKING NUTS

- Nylon Insert, Metric, Zinc Plated.
- 10 Sizes: M5 x 0.8 to M12 x 1.75 • 270 Pieces

Replacement Packs: Page 89 (C270-1 to C270-10)



CA276 SHIM STEEL WASHERS

- .006" Thickness
- 22 Sizes: 5/8" to 1-3/8" I.D. • 276 Pieces

Replacement Packs: Page 89 (C276-1 to C276-38)



CA280 SPLIT PINS

- Metric, Zinc Plated. • 11 Sizes: 5mm to 13mm Dia.
- Lengths to 150mm (Large Sizes) • 93 Pieces

Replacement Packs are not available. Refer to page 131 for refills.



CA290 MACHINE SCREWS & NUTS

- Round Head Slotted, BSW, Zinc Plated.
- 8 Sizes: 1/8" x 3/4" to 1/4" x 2" • 360 Pieces

Replacement Packs: Page 89 (C290-1 to C290-11)



CA300 HEX NUTS

- Metric Plain and Self-Locking, Zinc Plated.
- 12 Sizes: Plain M3 to M10, Self-Locking M4 to M10 • 320 Pieces

Replacement Packs: Page 90 (C300-1 to C300-12)



CA302 MOTORCYCLE FASTENERS

- Metric Socket Head Cap, Machine and Hex Screws, and Star Washers. Zinc Plated • 28 Sizes • 191 Pieces

Replacement Packs are not available



CA330 FLAT STEEL WASHERS

- Imperial and Metric, Zinc Plated.
- 10 Sizes: 3/16" to 3/4" & M10 I.D. • 330 Pieces

Replacement Packs: Page 90 (C330-1 to C330-10)



CA350 SELF-TAPPING SCREWS

- Hex Head, Zinc Plated.
- 14 Sizes: 6G to 14G • Lengths to 1" • 350 Pieces

Replacement Packs: Page 90 (C350-1 to C350-14)



CA360 SELF-LOCKING NUTS

- Nylon Insert, Metric, UNC, UNF and Zinc Plated.
- 10 Sizes: M6 to M10 & 1/4" to 3/8" • 166 Pieces

Replacement Packs: Page 90 (C360-1 to C360-10)



CA380 SPEED NUTS

- 'U' and Flat Types • Zinc Passivated
 - 12 Sizes: 3/32" to 3/16" Dia. • 390 Pieces
- Replacement Packs: Page 91 (C380-1 to C380-12)



CA390 FIBRE WASHERS

- 12 Sizes: 5/32" to 3/4" I.D.
 - Thickness: 1/16" • 405 Pieces
- Replacement Packs: Page 91 (C390-1 to C390-12)



CA400 FIBRE WASHERS

- 14 Sizes: 1/8" to 1" I.D.
 - Thickness: 1/32" • 430 Pieces
- Replacement Packs: Page 91 (C400-1 to C400-14)

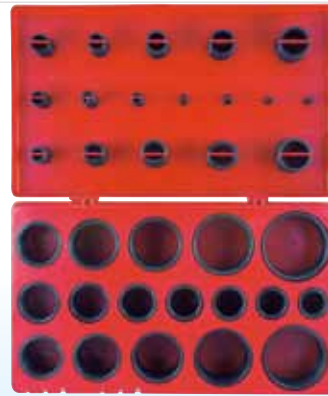

CA407 IMPERIAL 'O' RINGS

- Nitrile, 70 Shore.
 - 32 Sizes: 1/8" to 2" I.D. • 407 Pieces
- Replacement Packs: Page 91 (C407-1 to C407-32)



CA408 METRIC 'O' RINGS

- Nitrile, 70 Shore
 - 32 Sizes: 3mm to 50mm I.D. • 408 Pieces
- Replacement Packs: Page 92 (C408-1 to C408-32)



CA409 'O' RING SPLICING KIT, IMPERIAL

CA410 'O' RING SPLICING KIT, METRIC

- Nitrile, 70 Shore.
 - 5 Imperial Sizes: 'O' Ring Cord .070" to .275" (36" each)
 - 9 Metric Sizes: 'O' Ring Cord 1.5mm to 8.5mm (900mm each)
- Replacement Packs are not available

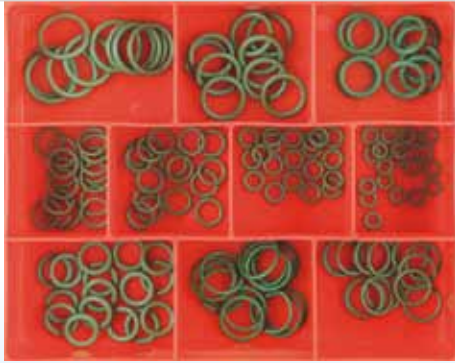

CA411 AIR CONDITIONING 'O' RINGS

- Suits R134A Gas. HMBR (Green), Imperial, 70 Shore.
- 10 Sizes: 3/16" to 3/4" • 145 Pieces

Replacement Packs: Page 92 (C411-1 to C411-10)



CA420 SELF-TAPPING SCREWS

- Raised and Pan Head Slotted, Zinc Plated.
- 12 Sizes: 6G to 12G • Lengths to 1" • 420 Pieces

Replacement Packs: Page 92 (C420-1 to C420-12)



CA430 SELF-TAPPING SCREWS

- Raised, Hex and Pan Head, Zinc Plated.
- 14 Sizes: 4G to 14G • Lengths to 1-1/2" • 430 Pieces

Replacement Packs: Page 92 (C430-1 to C430-14)



CA500 SPACING WASHERS STEEL

- Imperial
- 14 Sizes: 1/4" to 1-1/8" I.D. • Thickness: 22G (.028") • 545 Pieces

Replacement Packs: Page 93 (C500-1 to C500-14)



CA502 RIVETS

- Blind Aluminium
- 10 Sizes: 3/32" to 3/16" Dia. • 505 Pieces

Replacement Packs: Page 93 (C502-1 to C502-10)



CA505 RIVET NUT INSERTS

- 5 Sizes: 4mm to 10mm Dia. • 80 Pieces

Replacement Packs: Page 94 (C505-1 to C505-5)



CA510 STAR WASHERS

- Internal and External, Zinc Plated.
- 14 Sizes: 3/16" to 5/8" • 500 Pieces

Replacement Packs: Page 94 (C510-1 to C510-14)



CA520 SPRING WASHERS

- Imperial and Metric, Zinc Plated.
- 11 Sizes: 5/32" to 3/4" & M4 to M16 I.D. • 535 Pieces

Replacement Packs: Page 94 (C520-1 to C520-10)



CA530 SELF-DRILLING SCREWS

- Wafer and Hex Head, Yellow Zinc.
- 8 Sizes: 8G & 10G • Lengths to 30mm • 400 Pieces

Replacement Packs: Page 94 (C530-1 to C530-8)



CA540 SELF-TAPPING SCREWS

- Pan and Raised Head, Phillips, Nickel Plated.
- 13 Sizes: 4G to 10G • Lengths to 1-1/2" • 540 Pieces

Replacement Packs: Page 94 (C540-1 to C540-13)



CA550 SELF-TAPPING SCREWS

- Pan and Raised Head, Slotted, Zinc Plated.
- 13 Sizes: 6G to 12G • Lengths to 1" • 610 Pieces

Replacement Packs: Page 94 (C550-1 to C550-16)



CA560 SELF-TAPPING SCREWS

- Pan Head, Slotted, Zinc Plated.
- 8 Sizes: 6G to 10G • Lengths to 1-1/2" • 400 Pieces

Replacement Packs: Page 94 (C560-1 to C560-8)



CA570 ANTI-THEFT ONE WAY SCREWS

- Self-Tapping & 6mm Thread, incl. Washers & Nuts, Zinc Plated.
- 570 Pieces

Refer to page 94 for refills



CA576 FLAT STEEL WASHERS

- Imperial and Metric, Zinc Plated.
- 13 Sizes: 3/16" to 3/4" & 6mm to 20mm I.D. • 695 Pieces

Replacement Packs: Page 95 (C576-1 to C576-12)



CA600 FLAT STEEL HEAVY DUTY WASHERS

- Imperial, Zinc Plated.
- 8 Sizes: 3/16" to 3/4" I.D. • Thickness: 14G • 605 Pieces

Replacement Packs: Page 95 (C600-1 to C600-8)



CA648 SPRING WASHERS

- Imperial and Metric, Zinc Plated.
- 12 Sizes: 5/32" to 5/8" & 4mm to 20mm I.D. • 933 Pieces

Replacement Packs: Page 95 (C648-1 to C648-12)



CA800 SPLIT PINS

- Imperial, Zinc Plated.
- 10 Sizes: 1.6mm to 4mm Dia. incl. 7/64" & 9/64" Dia. • 795 Pieces

Replacement Packs: Page 95 (C800-1 to C800-10)



CA825 FIBRE WASHERS

- 14 Sizes: 1/8" to 1" I.D.
- Thickness: 1/32" • 825 Pieces

Replacement Packs: Page 95 (C825-1 to C825-14)



CA1008 SPRING WASHERS

- Square Section, Zinc Plated, Imperial.
- 8 Sizes: 3/16" to 3/4" I.D. • 895 Pieces

Replacement Packs: Page 95 (C1008-1 to C1008-8)



CA1152 SPLIT PINS

- Zinc Plated
- 8 Sizes: 1.6mm to 3.2mm Dia. incl. 7/64" Dia. • 800 Pieces

Replacement Packs: Page 95 (C1152-1 to C1152-8)



CA1200 SELF-TAPPING SCREWS

- Pan and Raised Head, Phillips, Black Zinc.
- 14 Sizes: 6G to 12G • Lengths to 1-1/2" • 415 Pieces

Replacement Packs: Page 95 (C1200-1 to C1200-14)



CA1320 LINKAGES (BALL JOINTS)

- 90° and Inline, Zinc Plated.
- 10 Sizes: 3/16" to 5/16" • 20 Pieces

Refer to page 217 for refills



CA1411 EXPANSION PLUGS

- Cup Type Steel, Zinc Plated, Metric.
- 12 Sizes: 18mm to 46.5mm • 48 Pieces

Replacement Packs: Page 96 (C1411-1 to C1411-12)



CA1412 BRASS OLIVES

- Suits Copper and Nylon Tube
- Sizes: Copper 1/8" to 1/2" and Nylon 3/16" to 3/8" • 330 Pieces

Replacement Packs: Page 96 (C1412-1 to C1412-12)



CA1416 SOCKET SET (GRUB) SCREWS

- Metric GR8.8 and Imperial.
 - 14 Sizes: 5mm to 8mm & 3/16" to 3/8" BSW • 164 Pieces
- Replacement Packs: Page 96 (C1416-1 to C1416-14)



CA1417 SOCKET HEAD CAP SCREWS

- Metric, High Tensile, GR8.8
 - 14 Sizes: M5 to M10 Dia. • 90 Pieces
- Replacement Packs: Page 96 (C1417-1 to C1417-14)



CA1418 SOCKET HEAD CAP SCREWS

- BSW, High Tensile.
 - 14 Sizes: 3/16" to 5/16" Dia. • Lengths to 1-1/2" • 92 Pieces
- Replacement Packs: Page 96 (C1418-1 to C1418-14)



CA1419 SOCKET HEAD CAP SCREWS

- Countersunk, Metric, GR8.8
 - Sizes: 4mm to 8mm Dia. • Lengths to 30mm • 124 Pieces
- Replacement Packs: Page 96 (C1419-1 to C1419-14)



CA1420 BUTTON HEAD CAP SCREWS

- Metric
 - 14 sizes: 4mm to 8mm Dia. • Lengths to 30mm • 124 Pieces
- Replacement Packs: Page 97 (C1420-1 to C1420-14)



CA1421 ROLL PINS

- Imperial
 - 18 Sizes: 1/16" to 1/4" Dia. (Small Sizes) • 380 Pieces
- Replacement Packs: Page 97 (C1421-1 to C1421-18)



CA1424 'E' CLIPS & RETAINER SPRINGS

- 14 Sizes: 3/32" to 5/8" • 740 Pieces

Replacement Packs: Page 97 (C1424-1 to C1424-14)



CA1435 ROLL PINS

- Imperial
- 12 Sizes: 3/16" to 3/8" Dia. (Large Sizes) • 89 Pieces

Replacement Packs: Page 97 (C1435-1 to C1435-12)



CA1460 POLYPROPYLENE WASHERS

- 10 Sizes: 18mm to 30mm & 1/2" to 1" I.D. • Thickness: 3mm
- 123 Pieces

Replacement Packs: Page 97 (C1460-1 to C1460-11)



CA1480 HEX SET SCREWS & NUTS

- Metric GR8.8, ISO and Fine Pitch, Zinc Plated.
- 9 Sizes: M6 to M12 Dia. • 139 Pieces

Refer to page 93 for refills. Replacement Packs C431 and C480



CA1660 COPPER WASHERS

- Metric
- 10 Sizes: 5mm to 24mm I.D. • Thickness: 1mm • 260 Pieces

Replacement Packs: Page 98 (C1660-1 to C1660-10)



CA1670 FLAT WASHERS

- Extra Heavy Duty, Imperial, Zinc Plated.
- 8 Sizes: 3/16" to 3/4" I.D. • Thickness: up to 9G • 325 Pieces

Replacement Packs: Page 98 (C1670-1 to C1670-8)



CA1680 POLYPROPYLENE WASHERS

- Imperial
 - 16 Sizes: 1/8" to 1" I.D. • Thickness: 1/32" • 490 Pieces
- Replacement Packs: Page 98 (C1680-1 to C1680-16)



CA1690 TAPER PINS

- 14 Sizes: No.0 x 1" to No.5 x 2" (Small Sizes)
 - 140 Pieces
- Replacement Packs: Page 98 (C1690-1 to C1690-14)



CA1700 TAPER PINS

- 14 Sizes: No.4 x 2-1/2" to No.10 x 6" (Large Sizes)
 - 33 Pieces
- Refer to page 132 for refills



CA1705 WOODRUFF KEYS

- Metric
 - 17 Sizes: 2mm x 10mm to 10mm x 32mm • 164 Pieces
- Replacement Packs: Page 98 (C1705-1 to C1705-17)



CA1710 SELF-TAPPING SCREWS

- Pan Head Phillips, Zinc Plated
 - 14 Sizes: 6G to 12G • Lengths to 2" • 415 Pieces
- Replacement Packs: Page 99 (C1710-1 to C1710-14)



CA1715 ROLL PINS

- Metric
 - 18 Sizes: 2mm to 6mm Dia. (Small Sizes) • 360 Pieces
- Replacement Packs: Page 99 (C1715-1 to C1715-18)



CA1720 SELF-TAPPING SCREWS

- Mushroom Head, Black Zinc.
 - 14 Sizes: 6G to 12G • Lengths to 2" • 415 Pieces
- Replacement Packs: Page 99 (C1720-1 to C1720-14)



CA1725 ROLL PINS

- Metric
 - 12 Sizes: 5mm to 10mm Dia. (Large Sizes) • 82 Pieces
- Replacement Packs: Page 99 (C1725-1 to C1725-12)



CA1730 PANEL (BODY) WASHERS

- Panel (Body) Steel and Stainless Steel, Zinc Plated.
 - 8 Sizes: 3/16" to 1/2" I.D. • 143 Pieces
- Replacement Packs: Page 99 (C1730-1 to C1730-8)



CA1735 PLASTIC TRIM CLIPS

- Including Screw Grommets
 - 14 Sizes • 180 Pieces
- Replacement Packs: Page 99 (C1735-1 to C1735-14)



CA1740 NYLON WASHERS

- Metric and Imperial
 - 11 Sizes: 12mm to 25mm & 1/2" to 13/16" I.D. • 160 Pieces
- Replacement Packs: Page 99 (C1740-1 to 1740-11)



CA1745 'R' CLIPS

- Zinc Plated
 - 8 Sizes: 1/8" to 1" (Shaft Size) • 124 Pieces
- Replacement Packs: Page 100 (C1745-1 to C1745-8)



CA1750 SHIM STEEL WASHERS

- 14 Sizes: 3/16" to 1" I.D.
- Thickness .006" • 190 Pieces

Replacement Packs: Page 100 (C1750-1 to C1750-14)



CA1755 FLAT STEEL WASHERS

- Imperial, High Tensile, Zinc Plated.
- 10 Sizes: 1/4" to 1" I.D. • 175 Pieces

Replacement Packs: Page 100 (C1755-1 to C1755-10)



CA1760 CIRCLIPS

- Metric, Internal and External.
- 14 Sizes: 6mm to 25mm • 155 Pieces

Replacement Packs: Page 100 (C1760-1 to C1760-14)



CA1765 LOCK RINGS

- External SPN Type
- 10 Sizes: 1.5mm to 12mm • 825 Pieces

Replacement Packs: Page 100 (C1765-1 to C1765-10)



CA1770 ALUMINIUM WASHERS

- Imperial and Metric • 15 Sizes: 1/4" to 1" I.D. & 5mm to 20mm I.D.
- Thickness: 1/16" • 315 Pieces

Replacement Packs: Page 100 (C1770-1 to C1770-15)



CA1772 TORX® SECURITY MACHINE SCREWS

- Metric, Pan Head, Zinc Plated.
- 15 Sizes: M4 to M6 Dia. • Lengths: 10mm to 30mm • 365 Pieces

Replacement Packs: Page 100 (C1772-1 to C1772-15)



CA1774 TORX® SECURITY MACHINE SCREWS

- Metric, Countersunk, Zinc Plated.
 - 13 Sizes: 4mm to 6mm • Lengths: 10mm to 30mm • 325 Pieces
- Replacement Packs: Page 101 (C1774-1 to C1774-13)



CA1776 TORX® SECURITY SELF-TAPPING SCREWS

- Pan Head, Zinc Plated.
 - 17 Sizes: 6G to 10G Dia. • Lengths: 13mm to 38mm • 425 Pieces
- Replacement Packs: Page 101 (C1776-1 to C1776-17)



CA1778 TORX® SECURITY SELF-TAPPING SCREWS

- Countersunk, Zinc Plated.
 - 17 Sizes: 6G to 10G Dia. • Lengths: 13mm to 38mm • 425 Pieces
- Replacement Packs: Page 101 (C1778-1 to C1778-17)



CA1780 STAR WASHERS

- Internal and External, Zinc Plated.
 - 14 Sizes: 4mm to 16mm • 560 Pieces
- Replacement Packs: Page 101 (C1780-1 to C1780-14)



CA1782 TORX® SECURITY SELF-DRILLING SCREWS

- Pan Head, Zinc Plated.
 - 15 Sizes: 6G to 10G Dia. • Lengths: 13mm to 38mm • 375 Pieces
- Replacement Packs: Page 101 (C1782-1 to C1782-15)



CA1784 TORX® SECURITY BUTTON HEAD SCREWS

- Metric, Zinc Plated.
 - 14 Sizes: M4 to M8 Dia. • Lengths: 16mm to 30mm • 270 Pieces
- Replacement Packs: Page 101 (C1784-1 to C1784-14)

Torx® is a registered trademark of Camcar Textron Inc.



CA1786 MACHINE SCREWS

- Metric, Countersunk, Zinc Plated.
 - 13 Sizes: M3 to M6 Dia. • Lengths: 16mm to 50mm • 345 Pieces
- Replacement Packs: Page 102 (C1786-1 to C1786-14)



CA1790 DRAIN (SUMP) PLUG WASHERS

- Aluminium Metric & Imperial. • 8 Sizes: 12mm to 24mm & 1/2" I.D.
 - Thickness: 2.5mm • 100 Pieces
- Replacement Packs: Page 102 (C1790-1 to C1790-8)



CA1792 NYLON NUTS

- Metric, Wing, Dome and Hex Nuts.
 - 9 Sizes: M5 to M8 Dia. & 5mm to 8mm • 255 Pieces
- Replacement Packs: Page 102 (C1792-1 to C1792-9)



CA1794 WING NUTS

- Metric and UNC, Zinc Plated.
 - 9 Sizes: M4 to M10, UNC 3/16" to 3/8" • 240 Pieces
- Replacement Packs: Page 102 (C1794-1 to C1794-9)



CA1796 COUPLING NUTS

- Metric and UNC, Zinc Plated.
 - 10 Sizes: M5 to M12 & 3/16" to 7/16" • 92 Pieces
- Replacement Packs: Page 102 (C1796-1 to C1796-10)











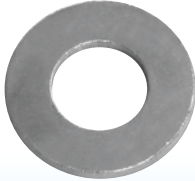





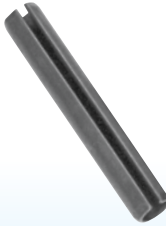













CA1798 WING SCREWS

- Metric, Zinc Plated.
 - 8 Sizes: M4 to M6 Dia. • Lengths: 16mm to 40mm • 95 Pieces
- Replacement Packs: Page 102 (C1798-1 to C1798-8)

STAINLESS STEEL

STAINLESS
STEEL

				
SPRING WASHER	FLAT WASHER	PANEL WASHER	INTERNAL STAR (SHAKEPROOF) WASHER	EXTERNAL STAR (SHAKEPROOF) WASHER
				
EXTERNAL SHAFT CIRCLIP	INTERNAL SHAFT CIRCLIP	'E' TYPE CLIP	ROLL PIN	RIVET
				
GREASE NIPPLE	TORX BUTTON HEAD SCREW	TORX SELF-TAPPING SCREW	GRUB SCREW	HEX PLAIN NUT
				
PAN TORX SELF TAPPING SCREW	COUNTERSUNK TORX SELF-TAPPING SCREW	PAN HEAD SELF-TAPPING SCREW	RAISED HEAD SELF-TAPPING SCREW	PAN TORX MACHINE SCREW
				
COUNTERSUNK TORX MACHINE SCREW	HEX BOLT	SOCKET HEAD	WING SCREW	COUNTERSUNK PHILLIPS MACHINE SCREW
				
PAN HEAD MACHINE SCREW	DOME NUT	SELF-LOCKING NUT	WING NUT	SPLIT (COTTER) PIN

Torx® is a registered trademark of Camcar Textron Inc.



STAINLESS STEEL ASSORTMENTS

PART NO.	IMAGE PAGE NO.	ASSORTMENTS
CA214	215	Stainless Steel Assortment – Screws, Washers and Nuts, 302/A2, 316/A4. 52 Sizes
CA1800	66	Stainless Steel Assortment – Bolts, Screws, Washers and Split Pins, 304/A2. 38 Sizes
CA1808	66	Stainless Steel Grease Nipples – Metric and Imperial, 316/A4. 14 Sizes
CA1810	66	Stainless Steel Self-Tapping Screws – Pan Head, Phillips, 304/A2. 15 Sizes: 4G to 10G – Lengths 1/2" to 1-1/2"
CA1815	66	Stainless Steel Roll Pins – Metric, 304/A2. 14 Sizes: 2mm to 6mm Dia.
CA1816	66	Stainless Steel (Grub) Screws – Metric and Imperial, 316/A4. 14 Sizes: 5mm to 8mm & 3/16" to 3/8" BSW
CA1817	66	Stainless Steel Cap Screws – Metric, 316/A4. 14 Sizes: 5mm to 10mm
CA1818	66	Stainless Steel Cap Screws – BSW, 316/A4. 14 Sizes: 3/16" to 3/8" – Lengths to 1-1/2"
CA1820	67	Stainless Steel Self-Tapping Screws – Countersunk, Phillips, 304/A2. 15 Sizes: 4G to 10G – Lengths to 1-1/2"
CA1824	67	Stainless Steel 'E' Clips – Metric, 304/A2. 8 Sizes: 1.9mm to 15mm
CA1830	67	Stainless Steel Flat and Panel Washers – 304/A2. 16 Sizes: 1/8" to 3/4" I.D.
CA1840	67	Stainless Steel Spring Washers – 304/A2, Imperial. 12 Sizes: 5/32" to 3/4" & 4mm to 16mm I.D.
CA1850	67	Stainless Steel Split Pins – Metric, 304/A2. 10 Sizes: 1.6mm to 5mm Dia.
CA1860	67	Stainless Steel Machine Screws and Nuts – BSW, 304/A2. 10 Sizes: 1/8" to 1/4"
CA1861	68	Stainless Steel Internal Circlips – Metric, 304/A2. 8 Sizes: 10mm to 25mm
CA1862	68	Stainless Steel External Circlips – Metric, 304/A2. 8 Sizes: 6mm to 22mm
CA1870	68	Stainless Steel Set Screws and Nuts – Metric, 304/A2. 13 Sizes: M4 to M10 Dia.
CA1875	68	Stainless Steel Set Screws and Nuts – UNC, 316/A4. 10 Sizes: 1/4" to 3/8" Dia.
CA1882	68	Torx® Stainless Steel Security Self-Tapping Screws – Pan Head, 304/A2. 14 Sizes: 6G to 12G Dia. – Lengths 1/2" to 1-1/2"
CA1884	68	Stainless Steel Self-Tapping Screws – Raised Countersunk, Phillips, 316/A4. 19 Sizes: 4G to 10G Dia. – Lengths 1/2" to 2"
CA1885	69	Stainless Steel Hex Set Screws and Nuts – Metric, 316/A4. 13 Sizes: 4mm to 10mm Dia. – Lengths 16 to 50mm
CA1886	69	Torx® Stainless Steel Security Machine Screws – Pan Head, 304/A2. 14 Sizes: M5 to M8 Dia. – Lengths 10 to 30mm
CA1888	69	Stainless Steel Machine Screws & Nuts – Pan Hd, Phillips, 316/A4. 14 Sizes: M5 to M6 Dia. – Lengths 10 to 50mm
CA1890	69	Stainless Steel Machine Screws & Nuts – Countersunk, Phillips, 316/A4. 11 Sizes: M5 to M6 Dia. – Lengths 16 to 50mm
CA1892	69	Stainless Steel Wing Screws & Nuts – Metric, 316/A4. 11 Sizes: M4 to M6 – Lengths 10mm to 25mm
CA1894	69	Stainless Steel Rivets Blind – 304/A2. 16 Sizes: 2.4mm to 5mm Dia.

STAINLESS STEEL



CA1800 ASSORTED PRODUCTS

- Bolts, Screws, Washers and Split Pins, 304/A2.
- 38 Sizes • 324 Pieces

Refer to page 102 for Replacement Packs



CA1808 GREASE NIPPLES

- Metric and Imperial, 316/A4.
- 14 Sizes • 170 Pieces

Replacement Packs: Page 103 (C1808-1 to C1808-14)



CA1810 SELF-TAPPING SCREWS

- Pan Head, Phillips, 304/A2.
- 15 Sizes: 4G to 10G • Lengths: 1/2" to 1-1/2" • 415 Pieces

Replacement Packs: Page 103 (C1810-1 to C1810-15)



CA1815 ROLL PINS

- Metric, 304/A2.
- 14 Sizes: 2mm to 6mm Dia. • 210 Pieces

Replacement Packs: Page 103 (C1815-1 to C1815-14)



CA1816 GRUB SCREWS

- Metric and Imperial, 316/A4.
- 14 Sizes: 5mm to 8mm & 3/16" to 3/8" BSW • 140 Pieces

Replacement Packs: Page 103 (C1816-1 to C1816-14)



CA1817 CAP SCREWS - METRIC

CA1818 CAP SCREWS - IMPERIAL

- Metric, 316/A4. • 14 Sizes: 5mm to 10mm
- Imperial, BSW, 316/A4. • 14 Sizes: 3/16" to 3/8" • Lengths to 1-1/2"

Replacement Packs: Page 103 (C1817-1 to 14) (C1818-1 to 14)



CA1820 SELF-TAPPING SCREWS

- Countersunk, Phillips, 304/A2.
 - 15 Sizes: 4G to 10G • Lengths to 1-1/2" • 415 Pieces
- Replacement Packs: Page 104 (C1820-1 to C1820-15)



CA1824 'E' CLIPS

- Metric, 304/A2.
 - 8 Sizes: 1.9mm to 15mm • 325 Pieces
- Replacement Packs: Page 104 (C1824-1 to C1824-8)



CA1830 FLAT & PANEL WASHERS

- 304/A2
 - 16 Sizes: 1/8" to 3/4" I.D. • 385 Pieces
- Replacement Packs: Page 104 (C1830-1 to C1830-16)



CA1840 SPRING WASHERS

- 304/A2, Imperial.
 - 12 Sizes: 5/32" to 3/4" & 4mm to 16mm I.D. • 345 Pieces
- Replacement Packs: Page 104 (C1840-1 to C1840-12)



CA1850 SPLIT PINS

- Metric, 304/A2.
 - 10 Sizes: 1.6mm to 5mm Dia. • 225 Pieces
- Replacement Packs: Page 104 (C1850-1 to C1850-10)



CA1860 MACHINE SCREWS & NUTS

- BSW, 304/A2.
 - 10 Sizes: 1/8" to 1/4" • 256 Pieces
- Replacement Packs: Page 104 (C1860-1 to C1860-14)



CA1861 INTERNAL CIRCLIPS

- Metric, 304/A2.
- 8 Sizes: 10mm to 25mm • 80 Pieces

Replacement Packs: Page 104 (C1861-1 to C1861-8)

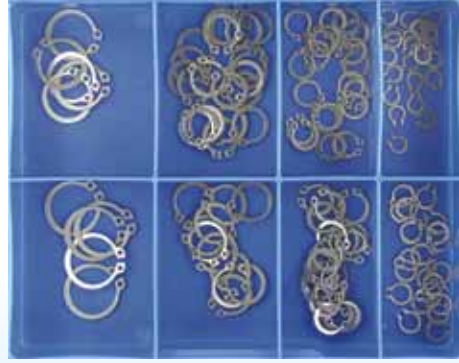

CA1862 EXTERNAL CIRCLIPS

- Metric, 304/A2.
- 8 Sizes: 6mm to 22mm • 120 Pieces

Replacement Packs: Page 105 (C1862-1 to C1862-8)



CA1870 SET SCREWS & NUTS

- Metric, 304/A2.
- 13 Sizes: M4 to M10 Dia. • 174 Pieces

Replacement Packs: Page 105 (C1870-1 to C1870-17)



CA1875 SET SCREWS & NUTS

- UNC, 316/A4.
- 10 Sizes: 1/4" to 3/8" Dia. • 140 Pieces

Replacement Packs: Page 105 (C1875-1 to C1875-10)



CA1882 TORX® SECURITY SELF-TAPPING SCREWS

- Pan Head, 304/A2.
- 14 Sizes: 6G to 12G Dia. • Lengths 1/2" to 1-1/2" • 210 Pieces

Replacement Packs: Page 105 (C1882-1 to C1882-14)



CA1884 SELF-TAPPING SCREWS

- Raised Countersunk, Phillips, 316/A4.
- 19 Sizes: 4G to 10G Dia. • Lengths: 1/2" to 2" • 440 Pieces

Replacement Packs: Page 105 (C1884-1 to C1884-19)

Torx® is a registered trademark of Camcar Textron Inc.



CA1885 SET SCREWS & NUTS

- Metric, 316/A4.
 - 13 Sizes: 4mm to 10mm Dia. • Lengths 16mm to 50mm • 328 Pieces
- Replacement Packs: Page 106 (C1885-1 to C1885-18)



CA1886 TORX® SECURITY MACHINE SCREWS

- Metric, Pan Head, 304/A2.
 - 14 Sizes: M5 to M8 Dia. • Lengths: 10mm to 30mm • 140 Pieces
- Replacement Packs: Page 106 (C1886-1 to C1886-14)



CA1888 MACHINE SCREWS & NUTS

- Pan Head, Phillips, 316/A4.
 - 14 Sizes: M5 to M6 Dia. • Lengths 10mm to 50mm • 345 Pieces
- Replacement Packs: Page 106 (C1888-1 to C1888-14)



CA1890 MACHINE SCREWS & NUTS

- Countersunk, Phillips, 316/A4.
 - 11 Sizes: M5 to M6 Dia. • Lengths: 16mm to 50mm • 295 Pieces
- Replacement Packs: Page 106 (C1890-1 to C1890-11)



CA1892 WING SCREWS & NUTS

- Metric, 316/A4.
 - 11 Sizes: M4 to M6 • Lengths: 10mm to 25mm • 230 Pieces
- Replacement Packs: Page 106 (C1892-1 to C1892-11)



CA1894 RIVETS

- Blind, 304/A2.
 - 16 Sizes: 2.4mm to 5mm Dia. • 330 Pieces
- Replacement Packs: Page 106 (C1894-1 to C1894-16)

STORAGE SYSTEMS

MASTER KIT METAL CABINETS
COMPLETE WITH ROLL OUT TRAYS



4 & 6
DRAWER
CAPACITY

CSD4 4 DRAWER 305H x 410W x 320D

CSD6 6 DRAWER 430H x 410W x 320D

*Storage cabinets are not
supplied with assortments*

Champion master kit cabinets are available in either 4 or 6 drawer capacity

These sturdy metal cabinets are complete with roll out trays

Attractively powder coated in red to complement the master kits



MASTER KITS – METAL CASE

Master Kits are supplied in a strong reusable metal case, complete with locking tab and a heavy duty insert tray.

All assortment componentry is of the highest quality and conforms to Australian and International standards.

Replacement packs and refill items are readily available.
See Replacement Pack section page 82-116



Champion Master Kits Cover an Extensive Range of Products

MASTER KITS

MASTER KITS - METAL CASES

Master Kits are supplied in a strong reusable metal case, complete with locking tab and a heavy duty insert tray.

Assortment componentry is of the highest quality and conforms to Australian and International standards.

Replacement packs and refill items are readily available.

For Storage Cabinets and Wire Rack Merchandisers see pages 80 & 219

PART NO.	IMAGE PAGE NO.	MASTER KIT
CA365	73	UNF Bolts, Set Screws and Nuts – High Tensile, GR5, Zinc Plated. 16 Sizes: 1/4" to 1/2" Dia.
CA370	73	UNC Bolts, Set Screws and Nuts – High Tensile, GR5, Zinc Plated. 16 Sizes: 1/4" to 1/2" Dia.
CA431	73	Metric Bolts, Set Screws and Nuts – High Tensile, GR8.8, Zinc Plated. 17 Sizes: M4 to M12 Dia.
CA480	73	Metric Bolts, Set Screws and Nuts – ISO and Fine Pitch, High Tensile, GR8.8, Z/P. 16 Sizes: M4 to M12 Dia.
CA495	73	Flange Head Hex Set Screws and Nuts – Metric, High Tensile, GR8.8, Zinc Plated. 17 Sizes: 5mm to 10mm
CA1630	73	Self-Tapping Screws – Phillips Raised, Pan Slot and Hex Head, incl. Cup Washers. Z/P and N/P. 19 Sizes: 6G to 14G
CA1880	74	Stainless Steel Metric Set Screws and Nuts – 304/A2. 16 Sizes: M4 to M12 Dia.
CA2005	74	Fuses – Glass, Blade and European. 28 Sizes: 2 Amp. to 50 Amp. – 24 Types
CA2010	74	Circlips – Metric, Internal. 20 Sizes: 8mm to 50mm (Bore Size)
CA2015	74	Circlips – Metric, External. 20 Sizes: 6mm to 50mm (Shaft Size)
CA2020	74	Roll Pins – Metric. 24 Sizes: 2mm to 10mm Dia. (Large Sizes)
CA2025	74	Roll Pins – Imperial. 24 Sizes: 3/32" to 3/8" Dia.
CA2030	75	Circlips – Imperial, Internal. 20 Sizes: 1/4" to 2" (Bore Size)
CA2035	75	Circlips – Imperial, External. 20 Sizes: 1/4" to 2" (Shaft Size)
CA2040	75	Wiring Terminals – Crimp Type. 28 Types incl. Push-On Bullet, Ring, Tab, Splice and Lanced
CA2045	75	Self-Tapping Screws – Pan and Mushroom Head, Phillips, Black Zinc. 28 Sizes: 6G to 12G, Lengths to 2"
CA2050	75	Flat and Spring Steel Washers – Imperial and Metric, Zinc Plated. 25 Sizes: 5/32" to 3/4" & 6mm to 20mm I.D.
CA2060	75	Fibre Washers – 36 Sizes: 5/32" to 1" & 14mm to 30mm I.D. – Thickness: 1/32", 1/16", 3/32"
CA2070	76	Brass Hose Fittings – 'T' Pieces, Joiners, Tails, Elbows and Adaptors. 53 Sizes, 106 Pieces
CA2075	76	Vacuum Hose and Tube Connectors – 49 Sizes, 136 Pieces
CA2080	76	Trim Clips – Scrivets. 16 Types, 675 Pieces
CA2085	76	Trim Clips – Xmas Tree Clips. 16 Types, 690 Pieces
CA2096	76	Manifold Studs and Nuts – Metric and Imperial, Steel and Brass, Zinc Passivated. 19 Sizes
CA2140	76	Drain (Sump) Plug Washers – Fibre, Aluminium and Copper Crush Metric. 25 Sizes: 12mm to 25mm I.D.
CA2173	77	Bonded Seal (Dowty) Washers – Metric and Imperial. 22 Sizes: 8mm to 42mm & 1/8" to 1-1/4" I.D. BSP
CA2174	77	Rubber Grommets – Wiring and Blanking. 20 Sizes: 1/8" to 1-1/8"
CA2177	77	Woodruff Keys – Imperial and Metric. 34 Sizes: 3/32" to 3/8" & 2mm to 10mm Dia.
CA2206	77	6mm Bolts & Nuts – H/T, incl. Self-Locking Nuts & Washers. Set Screws & Flange Head. Lengths: 16 to 40mm
CA2208	77	8mm Bolts & Nuts – H/T, incl. Self-Locking Nuts & Washers. Set Screws & Flange Head. Lengths: 20 to 50mm
CA2210	77	10mm Bolts & Nuts – H/T, incl. Self-Locking Nuts & Washers. Set Screws & Flange Head. Lengths: 25 to 50mm
CA2240	78	Flat and Body Steel Washers – Imperial and Metric, Zinc Plated. 20 Sizes: 1/8" to 1" & 6mm to 12mm I.D.
CA2260	78	Fuel Injection Copper Washers – Metric. 24 Sizes: 5mm to 26mm I.D. – Thickness: 1, 1.5 & 2mm
CA2265	78	Plastic Trim Clips and Screw Grommets – 20 Sizes, 275 Pieces
CA2276	78	Shim Steel Washers – 36 Sizes: 3/16" to 1-3/8" I.D. – Thickness: .006"
CA2300	78	Socket Head Cap Screws – BSW, High Tensile, 25 Sizes: 3/16" x 5/8" to 1/2" x 2-1/4"
CA2370	78	UNC Bolts, Set Screws and Nuts – High Tensile, GR8. 17 Sizes: 1/4" to 1/2" Dia. Lengths: 3/4" to 2"
CA2385	79	Fuses – Blade, Circuit Breaker, Micro and Mini Blades. 3 Amp. to 30 Amp. – 24 Types
CA2415	79	Grease Nipples – Combination Metric and Imperial, Zinc Plated. 20 Sizes
CA2417	79	Socket Head Cap Screws – Metric, GR8.8, Zinc Plated. 24 Sizes: 3mm to 8mm Dia.
CA2431	79	Metric Bolts, Set Screws and Nuts – High Tensile, Zinc Plated. 6 to 12mm Dia. Lengths: 20 to 50mm
CA2540	79	Split Pins – Metric, Zinc Plated. 16 Sizes: 1.6mm x 22mm to 6.3mm x 50mm
CA2700	79	Wiring Terminals – Crimp Type incl. Adjustable Ratchet Crimp Tool. Suitable for 3, 4 & 5mm Wire. 20 Types
CA2705	80	Machine Screws and Nuts – Pan Head, Phillips, Zinc Plated. 24 Sizes: M3 to M6 Dia.
CA2710	80	Machine Screws and Nuts – Metric, Countersunk Head, Zinc Plated. 20 Sizes: M3 to M6 Dia.
CA2715	80	Sems Assembly – Metric, Single and Double Washers, Zinc Passivated. 20 Sizes: M5 to M10 Dia.
CA2788	80	Nylon Bolts and Nuts – Hex Head. 19 Sizes: 5, 6 & 8mm Dia.



CA365 UNF BOLTS, SET SCREWS & NUTS

- High Tensile • GR5 • Zinc Plated
 - 16 Sizes: 1/4" to 1/2" Dia. • 365 Pieces
- Replacement Packs: Page 90 (C365-1 to C365-21)



CA370 UNC BOLTS, SET SCREWS & NUTS

- High Tensile • GR5 • Zinc Plated
 - 16 Sizes: 1/4" to 1/2" Dia. • 370 Pieces
- Replacement Packs: Page 91 (C370-1 to C370-21)



CA431 BOLTS, SET SCREWS & NUTS

- Metric • High Tensile • GR8.8 • Zinc Plated
 - 17 Sizes: M4 to M12 Dia. • 431 Pieces
- Replacement Packs: Page 93 (C431-1 to C431-22)



CA480 BOLTS, SET SCREWS & NUTS

- Metric • ISO and Fine Pitch • High Tensile • GR8.8
 - Zinc Plated • 16 Sizes: M4 to M12 Dia. • 480 Pieces
- Replacement Packs: Page 93 (C480-1 to C480-22)



CA495 BOLTS, SET SCREWS & NUTS

- Metric • Flange Head Plated • High Tensile • GR8.8
 - Zinc Plated • 17 Sizes: 5mm to 10mm Dia. • 455 Pieces
- Replacement Packs: Page 93 (C495-1 to C495-21)



CA1630 SELF-TAPPING SCREWS

- Phillips Raised, Pan Slot and Hex Head, incl. Cup Washers • Z/P
 - N/P • 19 Sizes: 6G to 14G • 1680 Pieces
- Replacement Packs: Page 97/98 (C1630-1 to C1630-22)



CA1880 SET SCREWS & NUTS

- Stainless Steel • Metric • GR 304/A2
 - 16 Sizes: M4 to M12 Dia. • 316 Pieces
- Replacement Packs: Page 105 (C1880-1 to C1880-22)



CA2005 FUSES

- Glass 2 to 50 Amp. • Blade 5 to 30 Amp. • European 8 to 25 Amp.
 - 28 Sizes • 24 Types • 300 Pieces
- Replacement Packs: Page 107 (C2005-1 to C2005-24)



CA2010 CIRCLIPS

- Internal • Metric
 - 20 Sizes: 8mm to 50mm (Bore Size) • 260 Pieces
- Replacement Packs: Page 107 (C2010-1 to C2010-20)



CA2015 CIRCLIPS

- External • Metric
 - 20 Sizes: 6mm to 50mm (Shaft Size) • 260 Pieces
- Replacement Packs: Page 107 (C2015-1 to C2015-20)



CA2020 ROLL PINS

- Metric • Large Sizes • 24 Sizes: 2mm to 10mm Dia.
 - 360 Pieces
- Replacement Packs: Page 107 (C2020-1 to C2020-24)



CA2025 ROLL PINS

- Imperial • 24 Sizes: 3/32" to 3/8" Dia.
 - 364 Pieces
- Replacement Packs: Page 108 (C2025-1 to C2025-24)



CA2030 CIRCLIPS

- Internal • Imperial • 20 Sizes: 1/4" to 2" (Bore Size)
 - 240 Pieces
- Replacement Packs: Page 108 (C2030-1 to C2030-20)



CA2035 CIRCLIPS

- External • Imperial • 20 Sizes: 1/4" to 2" (Shaft Size)
 - 240 Pieces
- Replacement Packs: Page 108 (C2035-1 to C2035-20)



CA2040 WIRING TERMINALS

- Crimp Type, incl. Push-On Bullet, Ring, Tab, Splice & Lanced
 - 28 Types • 364 Pieces
- Replacement Packs: Page 108 (C2040-1 to C2040-28)



CA2045 SELF-TAPPING SCREWS

- Pan and Mushroom Head • Phillips Drive • Black Zinc
 - 28 Sizes: 6G to 12G • Lengths: up to 2" • 830 Pieces
- Replacement Packs: p95 (C1200-1 to 14), p99 (C1720-1 to 14)



CA2050 FLAT & SPRING STEEL WASHERS

- Imperial and Metric • Zinc Plated
 - 25 Sizes: 5/32" to 3/4" & 6mm to 20mm I.D. • 1158 Pieces
- Replacement Packs: p95 (C756-1 to 12), p95 (C648-1 to 6)



CA2060 FIBRE WASHERS

- 36 sizes: 5/32" to 1" & 14mm to 30mm I.D.
 - Thickness: 1/32", 1/16", 3/32" • 1023 Pieces
- Rep. Packs: p91 (C400-1 to 14) (C390-1 to 12), p87 (C150-1 to 11)



CA2070 BRASS HOSE FITTINGS

- 'T' Pieces, Joiners, Tails, Elbows and Adaptors
 - 53 Sizes • 106 Pieces
- Replacements: See Brass, Page 153-155



CA2075 VACUUM HOSE & TUBE CONNECTORS

- 49 Sizes • 136 Pieces
- Replacements: See Page 180-181



CA2080 TRIM CLIPS

- Scrivets
 - 16 Types • 675 Pieces
- Replacements: See Page 119-123



CA2085 TRIM CLIPS

- Xmas Tree Clips
 - 16 Types • 690 Pieces
- Replacements: See Page 119-123



CA2096 MANIFOLD STUDS & NUTS

- Steel and Brass • Zinc Passivated
 - 19 Sizes • 200 Pieces
- Replacements: See Page 127



CA2140 DRAIN (SUMP) PLUG WASHERS

- Metric • Fibre, Aluminium and Copper Crush
 - 25 Sizes: 12mm to 25mm I.D. • 1015 Pieces
- Replacements: See Page 111



CA2173 BONDED SEAL (DOWTY) WASHERS

- Metric and Imperial
 - 22 Sizes: 8mm to 42mm & 1/8" to 1-1/4" I.D. BSP • 173 Pieces
- Replacement Packs: Page 111 (C2173-1 to C2173-22)



CA2174 RUBBER GROMMETS

- Wiring and Blanking • 20 Sizes: 1/8" to 1-1/8"
 - 174 Pieces
- Replacement Packs: p82 (C63-1 to 12), p83 (C90-1 to 8)



CA2177 WOODRUFF KEYS

- Imperial and Metric • 34 Sizes: 3/32" to 3/8" & 2mm to 10mm Dia.
 - 341 Pieces
- Replacement Packs: p87 (C177-1 to 17), p98 (C1705-1 to 17)



CA2206 6mm BOLTS & NUTS

- Incl. Self-Locking Nuts & Washers • High Tensile • GR8.8 • Z/P
 - Set Screws & Flange Head Lengths: 16mm to 40mm • 753 Pieces
- Replacements: See Page 112



CA2208 8mm BOLTS & NUTS

- Incl. Self-Locking Nuts & Washers • High Tensile • GR8.8 • Z/P
 - Set Screws & Flange Head Lengths: 20 to 50mm • 508 Pieces
- Replacements: See Page 112



CA2210 10mm BOLTS & NUTS

- Incl. Self-Locking Nuts & Washers • High Tensile • GR8.8 • Z/P
 - Set Screws & Flange Head Lengths: 25mm to 50mm • 401 Pieces
- Replacements: See Page 112-113



CA2240 FLAT & BODY STEEL WASHERS

- Imperial and Metric • Zinc Plated
 - 20 Sizes: 1/8" to 1" & 6mm to 12mm I.D. • 2190 Pieces
- Replacements: See Page 113



CA2260 FUEL INJECTION COPPER WASHERS

- Metric • 24 Sizes: 5mm to 26mm I.D. • Thickness: 1, 1.5 & 2mm
 - 565 Pieces
- Replacements: See Page 113



CA2265 TRIM CLIPS & SCREW GROMMETS

- Plastic • 20 Sizes • 275 Pieces
- Replacements: See Page 113



CA2276 SHIM STEEL WASHERS

- 36 Sizes: 3/16" to 1-3/8" I.D. • .006" Thickness
 - 466 Pieces
- Replacements: See Page 113-114



CA2300 SOCKET HEAD CAP SCREWS

- BSW • High Tensile
 - 25 Sizes: 3/16" x 5/8" to 1/2" x 2-1/4" • 300 Pieces
- Replacements: See Page 114



CA2370 BOLTS, SET SCREWS & NUTS

- UNC • High Tensile • GR8
 - 17 Sizes: 1/4" to 1/2" Dia. • Lengths: 3/4" to 2"
- Replacement Packs: Page 114 (C2370-1 to C2370-22)



CA2385 FUSES

- Blade, Circuit Breaker, Micro and Mini Blades • 3 Amp. to 30 Amp.
 - 24 Types • 400 Pieces
- Replacements: See Page 114



CA2415 GREASE NIPPLES

- Imperial and Metric • Zinc Plated
 - 20 Sizes • 410 Pieces
- Replacements: See Page 115



CA2417 SOCKET HEAD CAP SCREWS

- Metric • GR8.8 • Zinc Plated • 24 Sizes: 3mm to 8mm Dia.
 - 430 Pieces
- Replacements: See Page 115



CA2431 BOLTS, SET SCREWS & NUTS

- Metric • High Tensile • 6mm to 12mm Dia.
 - Lengths: 20mm to 50mm
- Replacement Packs: Page 115 (C2431-1 to C2431-20)



CA2540 SPLIT PINS

- Metric • Steel • Zinc Plated
 - 16 Sizes: 1.6 x 22mm to 6.3 x 50mm • 1540 Pieces
- Replacements: See Page 115



CA2700 WIRING TERMINALS

- Crimp Type incl. Adjustable Ratchet Crimp Tool
 - Suitable for 3mm, 4mm & 5mm Wire • 700 pieces • 20 Types
- Replacements: See Page 115



CA2705 MACHINE SCREWS

- Pan Head • Phillips • Zinc Plated • 24 Sizes: M3 to M6 Dia.
 - 1785 Pieces
- Replacements: See Page 116



CA2710 MACHINE SCREWS & NUTS

- Countersunk Head • Phillips • Zinc Plated
 - 20 Sizes: M3 to M6 Dia. • 1650 Pieces
- Replacements: See Page 116



CA2715 SEMS ASSEMBLY

- Metric • Single and Double Washers • Zinc Passivated
 - 20 Sizes: M5 to M10 Dia. • 380 Pieces
- Replacements: See Page 116



CA2788 NYLON BOLTS & NUTS

- Hex Head • 19 Sizes: 5, 6 & 8mm Dia.
- Replacement Packs: Page 116 (C2788-1 to C2788-22)



MASTER KIT METAL CABINETS

CSD4 4 DRAWER METAL CABINET

CSD6 6 DRAWER METAL CABINET

- 4 or 6 drawer Champion master kit cabinets
- Sturdy metal cabinet complete with roll out trays
- Attractively powder coated in red to complement the master kits
- CSD4 Dimensions: 305H x 410W x 320D (mm)
- CSD6 Dimensions: 430H x 410W x 320D (mm)

Storage cabinets are not supplied with assortments



REFILLS FOR CHAMPION ASSORTMENTS



Replacement Packs are clearly identified for easy replenishment of assortment

The relevant Replacement Pack part number is shown on the inner lid of the assortment

Available individually or in standard packs of five per outer

Replacement Packs are available for the majority of Champion and similar assortments

To ensure optimum performance and quality, always replace components with genuine Champion Replacement Packs.

REPLACEMENT PACKS

REPLACEMENT PACKS

REPLACEMENT
PACKS

CA21		MACHINE SCREWS & NUTS	
PAN HEAD PHILLIPS			
C21-1	20 / pack	M3 x 10mm	
C21-2	20	M3 x 16mm	
C21-3	20	M3 x 23mm	
C21-4	20	M4 x 10mm	
C21-5	20	M4 x 16mm	
C21-6	20	M4 x 20mm	
C21-7	20	M5 x 10mm	
C21-8	20	M5 x 16mm	
C21-9	20	M5 x 20mm	
C21-10	20	M5 x 25mm	
C21-11	30	M6 x 16mm	
C21-12	30	M6 x 20mm	
C21-13	60	M3 x 0.5 Nuts	
C21-14	60	M4 x 0.7 Nuts	
C21-15	80	M5 x 0.8 Nuts	
C21-16	60	M6 x 1.00 Nuts	

Bulk Packs: page 27

CA22		PIPE SUPPORT ANCHORS	
METAL WITH RUBBER PROTECTOR			
C22-1	8 / pack	10mm	
C22-2	4	13mm	
C22-3	4	16mm	
C22-4	4	19mm	
C22-5	4	27mm	
C22-6	4	35mm	

CA38		EXPANSION PLUGS	
CUP TYPE STEEL – IMPERIAL, ZINC PLATED			
C38-1	6 / pack	19/32"	
C38-2	6	1-7/32"	
C38-3	4	1-1/4"	
C38-4	4	1-3/8"	
C38-5	6	1-1/2"	
C38-6	6	1-5/8"	
C38-7	2	1-15/16"	
C38-8	2	1-61/64"	
C38-9	2	2"	
C38-10	6	3/4"	
C38-11	4	1"	
C38-12	2	1-3/4"	
C38-13	2	2-1/16"	

CA42		EXPANSION PLUGS	
CUP TYPE BRASS – IMPERIAL			
C42-1	6 / pack	3/4"	
C42-2	6	1"	
C42-3	3	1-7/32"	
C42-4	3	1-1/4"	
C42-5	2	1-3/8"	
C42-6	3	1-1/2"	
C42-7	4	1-5/8"	
C42-8	4	1-3/4"	
C42-9	2	2"	
C42-10	2	2-1/16"	

CA43		EXPANSION PLUGS	
CUP TYPE BRASS – METRIC			
C43-1	5 / pack	20mm	
C43-2	5	22mm	
C43-3	5	25mm	
C43-4	5	28mm	
C43-5	5	30mm	
C43-6	5	35mm	
C43-7	2	38mm	
C43-8	2	40mm	
C43-9	2	45mm	
C43-10	2	46.5mm	
C43-11	2	48mm	
C43-12	2	50mm	

CA52		CLEVIS PINS	
C52-1	8 / pack	1/4 x 1"	
C52-2	8	5/16 x 15/16"	
C52-3	8	5/16 x 1"	
C52-4	4	5/16 x 1-1/4"	
C52-5	4	5/16 x 1-3/4"	
C52-6	8	3/8 x 1"	
C52-7	4	3/8 x 1-1/8"	
C52-8	4	3/8 x 2"	
C52-9	4	7/16 x 1-1/2"	

Bulk Packs: page 124

CA58		DRAIN (SUMP) PLUGS	
<i>Assortment contents listed below</i>			
COR108	10 qty	1/2 x 1/16" 'O' Rings	
DP1	10	No.1 - 1/2" UNF Plug	
DP12	5	No.12 - M12 x 1.5 Plug	
DP12F	5	No.12F - M12 x 1.25 Plug	
DP14	8	No.14 - M14 x 1.5 Plug	
DP16	3	No.16 - 3/8" BSPP	
DP18	2	No.18 - M18 x 1.5 Plug	
DP10S	10	No.10/S - 1/2+ .028" Plug	
DP25	2	No.25 - M25 x 1.5 Plug	
DP3	3	No.3 - 5/8" UNF Plug	

Bulk Packs: page 125

CA63		WIRING GROMMET			
		I.D.	PANEL HOLE	O.D.	
C63-1	8 / pk	1/8"	x 9/32"	x 7/16"	
C63-2	8	3/16"	x 5/16"	x 7/16"	
C63-3	8	1/4"	x 1/2"	x 9/16"	
C63-4	8	5/16"	x 17/32"	x 3/4"	
C63-5	8	3/8"	x 1/2"	x 11/16"	
C63-6	8	3/8"	x 9/16"	x 11/16"	
C63-7	8	3/8"	x 3/4"	x 1"	
C63-8	8	7/16"	x 3/4"	x 1"	
C63-9	8	1/2"	x 21/32"	x 13/16"	
C63-10	5	5/8"	x 1"	x 1-1/8"	
C63-11	3	3/4"	x 15/16"	x 1-5/16"	
C63-12	3	29/32"	x 1-1/4"	x 1-1/2"	

Bulk Packs: page 126

CA70 BRASS FITTINGS

Assortment contents listed below

4502	2 qty	3/16" Nuts (Solder-On)
4503	4	1/4" Nuts (Solder-On)
4504	4	5/16" Nuts (Solder-On)
4505	2	3/8" Nuts (Solder-On)
P301	2	3/16 x 1/8" Male Barbs
P302	4	1/4 x 1/8" Male Barbs
P303	4	5/16 x 1/8" Male Barbs
P305	2	3/8 x 1/4" Male Barbs
P501	3	3/16 x 3/16" Nut & Tail
P503	4	1/4 x 1/8" Nut & Tail
P505	4	5/16 x 5/16" Nut & Tail
P506	3	3/8 x 3/8" Nut & Tail
P601	2	3/16 x 1/8" M/Elbow 90°
P602	3	1/4 x 1/8" M/Elbow 90°
P603	3	5/16 x 1/8" M/Elbow 90°
P605	2	3/8 x 1/4" M/Elbow 90°
P701	2	3/16" Hose Joiners
P702	3	1/4" Hose Joiners
P703	4	5/16" Hose Joiners
P704	2	3/8" Hose Joiners



Bulk Packs: p153-155

CA90 BLANKING GROMMETS

RUBBER

C90-1	20 / pack	5/16"
C90-2	15	3/8"
C90-3	15	1/2"
C90-4	10	5/8"
C90-5	10	3/4"
C90-6	5	7/8"
C90-7	8	1"
C90-8	8	1-1/8"



Bulk Packs: page 126

CA95 BRASS MANIFOLD NUTS

C95-1	4 / pack	1/4" UNC
C95-2	5	1/4" UNF
C95-3	4	1/4" BSF
C95-4	5	5/16" UNC
C95-5	6	5/16" BSF
C95-6	5	5/16" UNF
C95-7	4	M6 x 0.75mm
C95-8	4	M6 x 1.00mm
C95-9	4	M8 x 1.00mm
C95-10	4	M8 x 1.25mm
C95-11	6	3/8" BSF
C95-12	4	3/8" UNF
C95-13	12	3/8" UNC
C95-14	4	M10 x 1.5mm
C95-15	4	M10 x 1.25mm
C95-16	4	7/16" UNF
C95-17	4	7/16" UNC



Bulk Packs: page 127

CA96 MANIFOLD STUDS & NUTS

STEEL

C96-1	8 / pack	3/8 x 2" UNC Studs
C96-2	8	M8 x 38 x 1.25mm Studs
C96-3	8	7/16 x 2-1/4" UNC Studs
C96-4	8	M10 x 41 x 1.25mm Studs
C96-6	8	M10 x 40 x 1.5mm Studs
C96-11	8	3/8" UNC Nuts
C96-12	8	8 x 1.25mm Nuts
C96-13	8	7/16" UNC Nuts
C96-14	8	M10 x 1.25mm Nuts
C96-15	8	M10 x 1.5mm Nuts



Bulk Packs: page 127

CA98 EXPANSION PLUGS

STEEL DISC/LENS TYPE

C98-1	8 / pack	3/4"
C98-2	8	7/8"
C98-3	10	1"
C98-4	6	1-1/16"
C98-5	6	1-1/8"
C98-6	6	1-3/16"
C98-7	6	1-1/4"
C98-8	6	1-5/16"
C98-9	6	1-3/8"
C98-10	4	1-7/16"
C98-11	6	1-1/2"
C98-12	4	1-9/16"
C98-13	10	1-5/8"
C98-14	6	1-3/4"
C98-15	4	1-7/8"
C98-16	4	2"

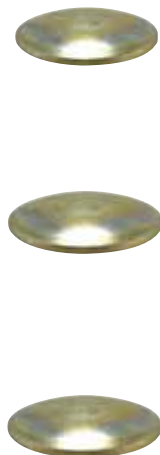

CA100 FLANGE NUTS

METRIC

C100-1	20 / pack	M5 x 0.8mm
C100-2	40	M6 x 1.00mm
C100-3	20	M8 x 1.25mm
C100-4	20	M10 x 1.25mm
C100-5	20	M10 x 1.5mm
C100-6	10	M12 x 1.75mm
C100-7	10	M12 x 1.25mm



Bulk Packs: page 148

CA101 EXTENSION SPRINGS

C101-25	4 / pack	4-3/4 x 1/2" x 15G
C101-26	4	4 x 9/16" x 16G
C101-27	4	3-3/4 x 1/2" x 17G
C101-28	4	2-1/2 x 1/2" x 17G
C101-29	4	3 x 7/16" x 18G
C101-30	4	2-1/2 x 11/32" x 20G
C101-31	4	3-1/8 x 11/32" x 20G
C101-32	4	2-7/8 x 9/32" x 21G
C101-33	4	2 x 9/32" x 21G
C101-34	4	2 x 7/32" x 24G
C101-35	4	1 x 7/32" x 24G
C101-36	4	1-1/2 x 3/16" x 26G



Bulk Packs: page 131

REPLACEMENT
PACKS

REPLACEMENT PACKS

REPLACEMENT PACKS

CA102	COMPRESSION SPRINGS	
C102-25	6 / pack	4 x 3/4" x 14G
C102-26	6	3-3/4 x 5/8" x 16G
C102-27	6	2-3/4 x 5/8" x 17G
C102-28	6	2 x 17/32" x 17G
C102-29	6	2-1/4 x 1/2" x 18G
C102-30	6	2-1/4 x 7/16" x 18G
C102-31	6	3 x 7/16" x 20G
C102-32	6	2-5/8 x 3/8" x 20G
C102-33	6	1-1/4 x 3/8" x 20G
C102-34	6	1-3/4 x 5/16" x 22G
C102-35	6	3 x 5/16" x 24G
C102-36	6	1-1/2 x 3/16" x 26G

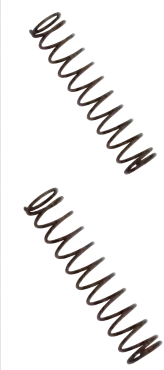

Bulk Packs: page 131

CA103	ACCELERATOR SPRINGS	
C103-1	4 / pack	6-1/2 x 7/16" x 20G
C103-2	4	6-5/8 x 3/8" x 21G
C103-3	4	6-3/4 x 5/16" x 21G
C103-4	4	6-3/8 x 5/16" x 21G
C103-5	4	5-1/8 x 7/16" x 18G
C103-6	4	5-3/8 x 5/16" x 22G
C103-7	4	4-1/2 x 1/4" x 23G
C103-8	4	6-15/16 x 7/32" x 24G
C103-9	4	5-3/4 x 3/16" x 25G



Bulk Packs: page 131

CA105	FUSES	
GLASS, BLADE & EUROPEAN		
C105-1	5 / pack	10 Amp. Blade Type
C105-2	5	15 Amp. Blade Type
C105-3	5	20 Amp. Blade Type
C105-4	5	SFE 14 Amp.
C105-5	5	8 Amp. European
C105-6	5	16 Amp. European
C105-9	5	3AG 10 Amp.
C105-10	15	3AG 15 Amp.
C105-11	10	3AG 20 Amp.
C105-12	10	3AG 25 Amp.
C105-13	10	3AG 30 Amp.
C105-14	10	3AG 35 Amp.
C105-15	5	25 Amp. European
C105-16	5	3AG 3 Amp.



Bulk Packs: page 125

CA106	WHEEL ALIGNMENT SHIMS	
IMPERIAL		
C106-1	15 / pack	1/32" Suits Ford
C106-2	10	1/16" Suits Ford
C106-3	6	1/8" Suits Ford
C106-4	20	1/32" Suits GM
C106-5	20	1/16" Suits GM
C106-6	7	1/8" Suits GM
C106-7	10	1/8" Suits GM
C106-8	10	1/16" Suits HK/HT Holden
C106-9	6	1/8" Suits HK/HT Holden
C106-10	10	1/32" Suits HQ Holden
C106-11	10	1/16" Suits HQ Holden
C106-12	7	1/8" Suits HQ Holden



Bulk Packs: page 130

CA107	WHEEL ALIGNMENT SHIMS	
METRIC		
C107-1	5 / pack	10 x 1mm
C107-2	5	10 x 2mm
C107-3	5	10 x 3mm
C107-4	10	12 x 1mm
C107-5	10	12 x 2mm
C107-6	10	12 x 3mm
C107-7	10	14 x 1mm
C107-8	15	14 x 2mm
C107-9	10	14 x 3mm
C107-10	10	1.5mm
C107-11	10	3.0mm



Bulk Packs: page 130

CA108	GREASE NIPPLES	
IMPERIAL		
C108-1	8 / pack	1/4" BSF Straight
C108-2	15	1/4" UNF Straight
C108-3	6	1/4" UNF 45°
C108-4	6	1/4" BSF 67-1/2°
C108-5	6	5/16" BSF Straight
C108-6	6	5/16" BSF 67-1/2°
C108-7	12	1/8" NPT Straight
C108-8	18	1/8" BSP Straight
C108-9	6	1/8" NPT 67-1/2°
C108-10	6	1/8" BSP 67-1/2°
C108-11	6	1/8" NPT 90°
C108-12	6	1/8" BSP 90°
C108-15	6	1/4" UNF x 1-1/4"
C108-16	3	1/4" BSP Straight
C108-17	3	1/4" UNF 90°



Bulk Packs: page 125

CA109	GREASE NIPPLES	
METRIC		
C109-1	40 / pack	6 x 1mm Straight
C109-2	7	6 x 1mm Self-Tapping
C109-3	10	6 x 1mm 45°
C109-4	8	6 x 1mm 90°
C109-5	8	8 x 1mm Straight
C109-7	5	8 x 1mm 45°
C109-8	5	8 x 1mm 90°
C109-9	5	8 x 1.25mm Straight
C109-11	5	8 x 1.25mm 90°
C109-12	4	10 x 1mm Straight
C109-13	4	10 x 1mm 45°
C109-14	4	10 x 1mm 90°





Bulk Packs: page 125

CA110	FUSES	
BLADE		
C110-1	10 / pack	3 Amp.
C110-2	10	5 Amp.
C110-3	10	7.5 Amp.
C110-4	10	10 Amp.
C110-5	25	15 Amp.
C110-6	25	20 Amp.
C110-7	10	25 Amp.
C110-8	10	30 Amp.



Bulk Packs: page 125

CA111		FUSES	
LOW PROFILE MINI			
C111-1	15 / pack	3 Amp.	
C111-2	15	5 Amp.	
C111-3	15	7.5 Amp.	
C111-4	15	10 Amp.	
C111-5	15	15 Amp.	
C111-6	15	20 Amp.	
C111-7	15	25 Amp.	
C111-8	15	30 Amp.	

CA112		FUSES	
MINI BLADE			
C112-1	15 / pack	3 Amp.	
C112-2	15	5 Amp.	
C112-3	15	7.5 Amp.	
C112-4	15	10 Amp.	
C112-5	15	15 Amp.	
C112-6	15	20 Amp.	
C112-7	15	25 Amp.	
C112-8	15	30 Amp.	

CA113		FUSES	
AF CIRCUIT BREAKER			
C113-1	5 / pack	5 Amp.	
C113-2	5	7.5 Amp.	
C113-3	5	10 Amp.	
C113-4	5	15 Amp.	
C113-5	5	20 Amp.	
C113-6	5	25 Amp.	
C113-7	5	30 Amp.	

CA115		'O' RINGS	
IMPERIAL			
		I.D.	SECTION
C115-1	10 / pack	3/16"	1/16"
C115-2	10	1/4"	1/16"
C115-3	10	5/16"	1/16"
C115-4	10	3/8"	1/16"
C115-5	10	3/8"	3/32"
C115-6	10	7/16"	3/32"
C115-7	10	1/2"	3/32"
C115-8	10	9/16"	3/32"
C115-9	10	5/8"	3/32"
C115-10	5	11/16"	3/32"
C115-11	5	3/4"	1/8"
C115-12	5	13/16"	1/8"
C115-13	5	7/8"	1/8"
C115-14	5	1"	1/8"

Bulk Packs: page 128

CA116		'O' RINGS	
METRIC			
		I.D.	SECTION
C116-1	10 / pack	5mm	2mm
C116-2	10	6mm	2mm
C116-3	10	7mm	2mm
C116-4	10	8mm	2mm
C116-5	10	9mm	2mm
C116-6	10	11mm	2.5mm
C116-7	10	13mm	2.5mm
C116-8	10	14mm	2.5mm
C116-9	10	16mm	2.5mm
C116-10	10	17mm	2.5mm
C116-11	10	19mm	2.5mm
C116-12	5	20mm	3.5mm
C116-13	5	22mm	3.5mm
C116-14	5	23mm	3.5mm
C116-15	5	25mm	3.5mm

Bulk Packs: page 128

CA118		'O' RING	
VITON – HIGH TEMP & HIGH PRESSURE			
		I.D.	SECTION
C118-1	10 / pack	7/32"	1/16"
C118-2	10	1/4"	1/16"
C118-3	10	5/16"	1/16"
C118-4	10	3/8"	1/16"
C118-5	10	3/8"	3/32"
C118-6	10	7/16"	3/32"
C118-7	10	1/2"	3/32"
C118-8	10	9/16"	3/32"
C118-9	10	3/4"	1/8"
C118-10	10	13/16"	1/8"
C118-11	5	7/8"	1/8"
C118-12	5	1"	1/8"

Bulk Packs: page 128

CA120		UNF SET SCREWS & NUTS	
HIGH TENSILE			
C120-1	5 / pack	1/4 x 1/2"	
C120-2	5	1/4 x 3/4"	
C120-3	5	1/4 x 1"	
C120-4	5	1/4 x 1-1/2"	
C120-5	5	5/16 x 3/4"	
C120-6	5	5/16 x 1"	
C120-7	3	5/16 x 1-1/4"	
C120-8	5	5/16 x 1-1/2"	
C120-9	5	3/8 x 1"	
C120-10	5	3/8 x 1-1/4"	
C120-11	5	3/8 x 1-1/2"	
C120-12	20	1/4" Nuts	
C120-13	20	5/16" Nuts	
C120-14	20	3/8" Nuts	

Bulk Packs: page 151

REPLACEMENT PACKS

REPLACEMENT PACKS

REPLACEMENT PACKS

CA124		CABLE CLAMPS & TIE MOUNTS	
NYLON CABLE 'P' CLAMPS & CABLE TIE MOUNTS			
C124-1	20 / pack	4.8mm Cable Clamps	
C124-2	20	6.3mm Cable Clamps	
C124-3	15	7.9mm Cable Clamps	
C124-4	12	9.5mm Cable Clamps	
C124-5	15	12.7mm Cable Clamps	
C124-6	15	15.8mm Cable Clamps	
C124-7	15	3.5mm Tie Mounts	
C124-8	12	5mm Tie Mounts	

CA125		UNC SET SCREWS & NUTS	
HIGH TENSILE			
C125-1	5 / pack	1/4 x 1-1/2"	
C125-2	5	5/16 x 1-1/2"	
C125-3	5	3/8 x 1"	
C125-4	5	3/8 x 1-1/2"	
C125-5	5	1/4 x 1/2"	
C125-6	5	1/4 x 3/4"	
C125-7	5	1/4 x 1"	
C125-8	5	5/16 x 3/4"	
C125-9	5	5/16 x 1"	
C125-10	3	5/16 x 1-1/4"	
C125-11	5	3/8 x 1-1/4"	
C125-12	20	1/4" Nuts	
C125-13	20	5/16" Nuts	
C125-14	20	3/8" Nuts	

Bulk Packs: page 150

CA126		SELF-LOCKING NUTS	
NYLON INSERT, UNC & UNF			
C126-1	15 / pack	3/16" UNC	
C126-2	15	1/4" UNC	
C126-3	10	5/16" UNC	
C126-4	8	3/8" UNC	
C126-5	5	7/16" UNC	
C126-6	3	1/2" UNC	
C126-7	20	3/16" (10/32") UNF	
C126-8	25	1/4" UNF	
C126-9	10	5/16" UNF	
C126-10	10	3/8" UNF	
C126-11	5	7/16" UNF	
C126-12	5	1/2" UNF	

Bulk Packs: page 152

CA132		BRASS FITTINGS	
OLIVES, UNIONS, FLARE NUTS & REDUCING BUSHES			
<i>Assortment contents listed below</i>			
103	20 qty	1/4" Compress Olive	
104	20	5/16" Compress Olive	
203	5	1/4" Std Compress Nut	
204	5	5/16" Std Compress Nut	
304	3	1/4 x 1/8" Single Union M	
307	3	5/16 x 1/8" Single Union M	
403	2	1/4 x 1/4" Double Union M	
404	2	5/16 x 5/16" Dbl Union M	
504	2	1/4 x 1/8" Male Elbow 90°	

CA132		BRASS FITTINGS <i>Continued</i>	
OLIVES, UNIONS, FLARE NUTS & REDUCING BUSHES			
<i>Assortment contents listed below</i>			
507	2 qty	5/16 x 1/8" Male Elbow 90°	
603	3	1/4" Standard Flare Nut	
605	3	5/16" Standard Flare Nut	
706	2	1/4 x 1/8" Single Fl. Union	
710	2	5/16 x 1/8" Single Fl. Union	
804	2	1/4 x 1/8" Flare Elbow 90°	
808	2	5/16 x 1/8" Fl. Elbow 90°	
2102	2	3/16 Nut (Dole Pattern)	
2103	3	1/4 Nut" (Dole Pattern)	
2104	2	5/16 Nut" (Dole Pattern)	
2202	2	3/16 x 1/8" Body (Dole)	
2204	2	1/4 x 1/8" Body (Dole)	
2205	2	5/16 x 1/8" Body (Dole)	
2302	1	3/16 x 1/8" Elbow (Dole)	
2303	2	1/4 x 1/8" Elbow (Dole)	
2304	1	5/16 x 1/8" Elbow (Dole)	
2401	3	1/4 x 1/8" Reducing Bush	
5802	2	3/16" Brass Nut Inv. Flare	
5803	2	1/4" Brass Nut Inv. Flare	
5804	2	5/16" Brass Nut Inv. Flare	
5902	1	3/16 x 1/8" Elbow Inv. Flare	
5903	2	1/4 x 1/8" Elbow Inv. Flare	
5905	1	5/16 x 1/8" Elbow Inv. Flare	
6001	3	1/4 x 1/2 x 20TPI Carb Nut	

Bulk Packs: p153-155

CA134		BRASS FITTINGS	
SINGLE & DOUBLE UNIONS, NUTS & ELBOWS			
<i>Assortment contents listed below</i>			
103	30 qty	1/4" Compression Olive	
104	30	5/16" Compression Olive	
203	5	1/4" Std Compression Nut	
204	5	5/16" Std Compress Nut	
304	2	1/4 x 1/8" Male Single Union	
307	2	5/16 x 1/8" M Single Union	
403	2	1/4 x 1/4" Male Double Union	
404	2	5/16 x 5/16" Male Dbl Union	
504	2	1/4 x 1/8" Male Elbow 90°	
507	2	5/16 x 1/8" Male Elbow 90°	
603	3	1/4" Standard Flare Nut	
605	3	5/16" Standard Flare Nut	
706	2	1/4 x 1/8" Single Fl. Union	
710	2	5/16 x 1/8" Single Fl. Union	
P301	2	3/16 x 1/8" Male Barb	
P302	3	1/4 x 1/8" Male Barb	
P303	3	5/16 x 1/8" Male Barb	
P304	1	3/8 x 1/8" Male Barb	
P501	2	3/16 x 3/16" Nut & Tail	
P503	3	1/4 x 1/8" Nut & Tail	
P505	3	5/16 x 5/16" Nut & Tail	
P506	1	3/8 x 3/8" Nut & Tail	

Bulk Packs: p153-155

CA140		DRAIN (SUMP) PLUG WASHERS	
C140-1	10 / pack	12 x 24 x 2.00 Wht Fibre	
C140-2	10	16 x 22 x 2.00 Wht Fibre	
C140-3	5	18 x 28 x 2.00 Wht Fibre	
C140-4	5	25 x 35 x 2.00 Wht Fibre	

CA140	DRAIN (SUMP) PLUG WASHERS <i>Continued</i>	
C140-5	10 / pack	12 x 18 x 1.5 Aluminium
C140-6	10	14 x 20 x 1.5 Aluminium
C140-7	10	18 x 24 x 1.5 Aluminium
C140-8	10	12 x 24 x 2.00 Blk Fibre
C140-9	10	18 x 28 x 2.00 Blk Fibre
C140-10	6	12 x 18 x 2.00 Copp. Crush
C140-11	6	16 x 22 x 2.00 Copp. Crush
C140-12	10	24 x 30 x 1.8 Aluminium



Bulk Packs: page 133

CA150	FIBRE DRAIN (SUMP) PLUG WASHERS – 3/32"	
IMPERIAL & METRIC		
C150-1	40 / pack	1/2 x 3/4"
C150-2	10	5/8 x 7/8"
C150-3	30	3/4 x 1-1/8"
C150-4	10	13/16 x 1-1/16"
C150-5	10	7/8 x 1-1/4"
C150-6	10	1 x 1-3/8"
C150-8	3	18 x 27mm
C150-9	10	30 x 38mm
C150-10	10	14 x 20mm
C150-11	10	No.1 O/S Plug



Bulk Packs: page 133

CA155	CIRCLIPS	
IMPERIAL, EXTERNAL & INTERNAL		
C155-1	20 / pack	1/4" External
C155-2	20	5/16" External
C155-3	20	3/8" External
C155-4	20	7/16" External
C155-5	20	1/2" External
C155-6	10	5/8" External
C155-7	5	3/4" External
C155-8	5	7/8" External
C155-9	5	1" External
C155-10	10	1/2" Internal
C155-11	5	5/8" Internal
C155-12	5	3/4" Internal
C155-13	5	7/8" Internal
C155-14	5	1" Internal



Bulk Packs: page 124

CA161	WIRING TERMINALS	
INSULATED CRIMP TYPE		
C161-1	14 / pack	320WF Blue
C161-2	12	309WF Red
C161-3	6	KSR100 Red Wire Tap
C161-4	6	KSB100 Blue Wire Tap
C161-5	14	320M Blue Tab
C161-6	12	309M Red Tab
C161-7	10	TG2 Blue Butt Splice
C161-8	5	TG1 Red Butt Splice
C161-9	5	TG3 Yellow Butt Splice
C161-10	10	153V Quick Conn Adapt.
C161-11	15	13-5 Red Ring
C161-12	12	22-5 Blue Ring
C161-13	10	22Y-4 Blue Spade
C161-14	5	53-8 Yellow Ring



Bulk Packs: page 135

CA177	WOODRUFF KEYS		
C177-1	12 / pk	1/2 x 3/32"	WK2
C177-2	24	1/2 x 1/8"	WK3
C177-3	24	5/8 x 1/8"	WK5
C177-4	12	5/8 x 5/32"	WK6
C177-5	12	3/4 x 1/8"	WK7
C177-6	12	3/4 x 3/16"	WK9
C177-7	12	3/4 x 5/32"	WK8
C177-8	12	7/8 x 3/16"	WK11
C177-9	12	1 x 3/16"	WK13
C177-10	12	1 x 1/4"	WK15
C177-11	6	1-1/8 x 3/16"	WK16
C177-12	6	1-1/8 x 1/4"	WK18
C177-13	3	1-1/4 x 1/4"	WK21
C177-14	6	7/8 x 1/4"	WKA
C177-15	6	1-1/8 x 5/16"	WKC
C177-16	3	1-1/4 x 5/16"	WKD
C177-17	3	1-1/4 x 3/8"	WKE



Bulk Packs: p135

CA178	BRASS FITTINGS	
SINGLE & DOUBLE UNIONS, DOLE NUTS, M/F ELBOWS, NIPPLES & PLUGS		

Assortment contents listed below

101	10 qty	101 Suit 1/8" Copper
102	20	3/16" Sleeve Compression
201	3	1/8 Std Compression Nut
202	5	3/16 Std Compression Nut
2101	3	1/8" Nut (Dole Pattern)
2501E	3	1/8 x 1/8" M&F Elbow (Extr.)
2601	3	1/8" Hexagon Socket
2602	2	1/4" Hexagon Socket
2701	2	1/8" BSP Hex Nipple
2702	2	1/4" BSP Hex Nipple
2901	3	1/4 x 1/8" Hex Reducing Nipple
301	3	1/8 x 1/8" Single Union Male
302	5	3/16 x 1/8" Single Union Male
401	2	1/8 x 1/8" Double Union Male
402	4	3/16 x 3/16" Double Union Male
4401	3	1/8" Tail (Solder-On)
4402	5	3/16" Tail (Solder-On)
4403	10	1/4" Tail (Solder-On)
4404	10	5/16" Tail (Solder-On)
4405	5	3/8" Tail (Solder-On)
4501	3	1/8" Nut (Solder-On)
4502	3	3/16" Nut (Solder-On)
4503	10	1/4" Nut (Solder-On)
4504	10	5/16" Nut (Solder-On)
4505	5	3/8" Nut (Solder-On)
4603	2	1/4 x 1/8" Single Union Solder-On
4605	2	5/16 x 1/8" Single Union Solder-On
4703	2	1/4" Double Union (Solder-On)
4704	2	5/16" Double Union (Solder-On)
6401	5	1/8" Plug (Taper)
6402	3	1/4 BSP Taper Plug Solid
7101	5	1/8 x 1/2" Tank Collar



Bulk Packs: p153-155

REPLACEMENT PACKS

REPLACEMENT PACKS

CA196		SET SCREWS & NUTS	
METRIC, HIGH TENSILE			
C196-1	20 / pk	M4 x 20mm	
C196-2	10	M5 x 25mm	
C196-3	5	M5 x 35mm	
C196-4	10	M6 x 16mm	
C196-5	10	M6 x 20mm	
C196-6	10	M6 x 25mm	
C196-7	10	M6 x 40mm	
C196-8	10	M8 x 20mm	
C196-9	8	M8 x 25mm	
C196-10	5	M8 x 35mm	
C196-11	5	M8 x 40mm	
C196-12	8	M8 x 50mm	
C196-13	5	M10 x 30mm	
C196-14	30	M8 x 1.25 Nuts	
C196-15	20	M4 x 0.7 Nuts	
C196-16	15	M5 x 0.8 Nuts	
C196-17	40	M6 x 1.00 Nuts	

Bulk Packs: page 142

CA200		FLANGE HEAD HEX SET SCREWS & NUTS	
<i>Assortment contents listed below</i>			
961125100025FB	5 qty	10 x 25 x 1.25	
961125100035FB	4	10 x 35 x 1.25	
961125100040FB	5	10 x 40 x 1.25	
961125100050FB	3	10 x 50 x 1.25	
M93305016FB	10	5 x 16 8AF	
M93305025FB	10	5 x 25 8AF	
M933060016FB	10	6 x 16 10AF	
M933060020FB	10	6 x 20 10AF	
M933060030FB	8	6 x 30 10AF	
M933060040FB	5	6 x 40 10AF	
M933080016FB	8	8 x 16 12AF	
M933080020FB	8	8 x 20 12AF	
M933080030FB	8	8 x 30 12AF	
M933080050FB	5	8 x 50 12AF	
M93405008	20	M5 x 0.8 Nuts	
M93406100	33	M6 x 1.00 Nuts	
M93408125-12AF	33	M8 x 1.25 12AF Nuts	
M93410125-14AF	17	M10 x 1.25 14AF Nuts	

Bulk Packs: page 145

CA212		'O' RINGS – HIGH PRESSURE SERIES			
NITRILE, IMPERIAL, 90 SHORE					
		TUBE (REF)	CROSS I.D.	SECTION	
C212-1	10 / pk	3/32"	.185	.056	
C212-2	10	1/8"	.239	.064	
C212-3	10	3/16"	.301	.064	
C212-4	10	1/4"	.351	.072	
C212-5	12	5/16"	.414	.072	
C212-6	12	3/8"	.468	.078	

CA212		'O' RINGS – HIGH PRESSURE SERIES <i>Continued</i>			
NITRILE, IMPERIAL, 90 SHORE					
		TUBE (REF)	CROSS I.D.	SECTION	
C212-7	12 / pack	7/16"	.530	.082	
C212-8	12	1/2"	.644	.087	
C212-9	12	9/16"	.706	.097	
C212-10	12	5/8"	.755	.097	
C212-11	10	11/16"	.863	.116	
C212-12	10	3/4"	.924	.116	
C212-13	10	13/16"	.986	.116	
C212-14	10	7/8"	1.047	.116	
C212-16	10	1"	1.171	.116	
C212-18	10	1-1/8"	1.355	.116	
C212-20	10	1-1/4"	1.475	.118	
C212-24	10	1-1/2"	1.720	.118	
C212-28	10	1-3/4"	2.090	.118	
C212-32	10	2"	2.337	.118	

CA225		COPPER WASHERS	
IMPERIAL, 20G THICK			
C225-1	35 / pack	1/4 x 9/16"	
C225-2	35	5/16 x 5/8"	
C225-3	40	3/8 x 3/4"	
C225-4	30	7/16 x 13/16"	
C225-5	40	1/2 x 7/8"	
C225-6	20	9/16 x 15/16"	
C225-7	20	5/8 x 1"	
C225-8	10	11/16 x 1-1/16"	
C225-9	15	3/4 x 1-1/8"	
C225-10	5	3/16 x 1-3/16"	
C225-11	5	7/8 x 1-3/8"	
C225-12	5	1 x 1-1/2"	

Bulk Packs: page 133

CA226		FUEL INJECTION COPPER WASHERS	
C226-1	25 / pack	6 x 10 x 1mm	
C226-2	25	8 x 12 x 1mm	
C226-3	25	8 x 14 x 1mm	
C226-4	25	10 x 14 x 1mm	
C226-5	25	10 x 16 x 1mm	
C226-6	25	12 x 16 x 1.5mm	
C226-7	25	12 x 18 x 1.5mm	
C226-8	25	14 x 18 x 1.5mm	
C226-9	25	14 x 20 x 1.5mm	
C226-10	25	16 x 20 x 1.5mm	
C226-11	25	16 x 22 x 1.5mm	
C226-12	10	18 x 24 x 1.5mm	
C226-13	10	20 x 26 x 1.5mm	
C226-14	10	26 x 31 x 2mm	

Bulk Packs: page 133

CA228		MACHINE SCREWS & NUTS	
FINE THREAD ROUND HEAD SLOTTED, NICKEL PLATED			
C228-1	18 / pack	6/40 x 1/2"	
C228-2	18	6/40 x 3/4"	
C228-3	24	6/40 x 1"	
C228-4	18	8/36 x 1/2"	
C228-5	18	8/36 x 3/4"	
C228-6	24	8/36 x 1"	
C228-7	24	8/36 x 1-1/4"	
C228-8	24	10/32 x 1/2"	
C228-9	24	10/32 x 1"	
C228-10	18	10/32 x 1-1/4"	
C228-11	18	10/32 x 1-1/2"	
C228-12	24	6/40" Nuts	
C228-13	24	8/36" Nuts	
C228-14	24	10/32" Nuts	

CA240		CONNECTOR BLOCKS	
C240-1	10 / pack	2 Pole Male	
C240-2	10	2 Pole Female	
C240-3	20	4 Pole Male	
C240-4	20	4 Pole Female	
C240-5	30	6 Pole Male	
C240-6	30	6 Pole Female	
C240-7	40	8 Pole Male	
C240-8	40	8 Pole Female	
C240-9	100	Blade Male Replace Term.	
C240-10	100	Spade Female Replace Term.	

CA252		MACHINE SCREWS & NUTS	
MUSHROOM HEAD SLOTTED, UNC, ZINC PLATED			
C252-1	36 / pack	3/16 x 1/2"	
C252-2	36	3/16 x 3/4"	
C252-3	36	3/16 x 1"	
C252-4	36	3/16 x 1-1/2"	
C252-5	36	1/4 x 3/4"	
C252-6	24	1/4 x 1"	
C252-7	24	1/4 x 1-1/4"	
C252-8	24	1/4 x 1-1/2"	
C252-9	24	3/16" Nuts	
C252-10	24	1/4" Nuts	

Bulk Packs: page 129

CA270		SELF-LOCKING NUTS	
C270-1	50 / pack	M5 x 0.8mm	
C270-2	50	M6 x 1.00mm	
C270-3	20	M8 x 1.00mm	
C270-4	25	M8 x 1.25mm	
C270-5	20	M10 x 1.00mm	
C270-6	25	M10 x 1.25mm	
C270-7	25	M10 x 1.50mm	
C270-8	20	M12 x 1.25mm	
C270-9	15	M12 x 1.50mm	
C270-10	20	M12 x 1.75mm	

Bulk Packs: page 148

CA276		SHIM STEEL WASHERS	
.006" THICK			
C276-1	18 / pack	5/8 x 1-1/8"	
C276-2	24	3/4 x 1-7/16"	
C276-3	18	7/8 x 1-5/8"	
C276-4	24	27/32 x 1-5/16"	
C276-6	6	1 x 2"	
C276-10	12	25/32 x 1-5/16"	
C276-12	12	1-1/8 x 1-5/8"	
C276-13	6	1-3/8 x 1-3/4"	
C276-15	12	3/4 x 1-1/16"	
C276-16	12	15/16 x 1-5/8"	
C276-17	12	7/8 x 1-7/16"	
C276-18	12	13/16 x 1-7/16"	
C276-19	18	7/8 x 1-9/16"	
C276-20	6	15/16 x 1-3/4"	
C276-21	18	1-1/8 x 1-13/16"	
C276-22	6	1-1/32 x 1-5/8"	
C276-23	6	25/32 x 1-1/4"	
C276-24	6	29/32 x 1-1/2"	
C276-25	6	3/4 x 1-5/8"	
C276-27	6	19/64 x 1-27/32"	
C276-36	12	3/4 x 1-3/8"	
C276-38	24	1-1/16 x 1-1/8"	

CA280		SPLIT PINS	
LARGE SIZES			
CPS10100	5 / pack	3/8 x 4"	
CPS10150	2	3/8 x 6"	
CPS13150	1	1/2 x 6"	
CPS50040	10	5.0 x 40mm	
CPS50050	10	5.0 x 50mm	
CPS50100	10	5.0 x 100mm	
CPS60050	10	6.0 x 50mm	
CPS60100	10	6.0 x 100mm	
CPS63050	10	6.3 x 50mm	
CPS63100	5	6.3 x 100mm	
CPS63120	5	6.3 x 120mm	
CPS80080	5	8.0 x 80mm	
CPS80100	5	8.0 x 100mm	
CPS80150	5	8.0 x 150mm	

Bulk Packs: page 131

CA290		MACHINE SCREWS & NUTS	
ROUND HEAD SLOTTED, BSW, ZINC PLATED			
C290-1	48 / pack	1/8 x 3/4"	
C290-2	48	1/8 x 1-1/4"	
C290-3	48	3/16 x 3/4"	
C290-4	48	3/16 x 1"	
C290-5	24	3/16 x 1-1/2"	
C290-6	24	1/4 x 1"	
C290-7	24	1/4 x 1-1/2"	
C290-8	24	1/4 x 2"	
C290-9	24	1/8" Nuts	
C290-10	24	3/16" Nuts	
C290-11	24	1/4" Nuts	

REPLACEMENT PACKS

REPLACEMENT
PACKS

CA300		HEX NUTS	
METRIC, PLAIN & SELF-LOCKING NUTS			
C300-1	50 /pk	M3 x 0.5 Plain	
C300-2	50	M4 x 0.7 Plain	
C300-3	50	M5 x 0.8 Plain	
C300-4	30	M6 x 1.00 Plain	
C300-5	20	M7 x 1.00 Plain	
C300-6	15	M8 x 1.25 Plain	
C300-7	20	M10 x 1.5 Plain	
C300-8	25	M4 x 0.7 Self-Locking	
C300-9	20	M5 x 0.8 Self-Locking	
C300-10	20	M6 x 1.00 Self-Locking	
C300-11	10	M8 x 1.25 Self-Locking	
C300-12	10	M10 x 1.5 Self-Locking	

Bulk Packs: page 152

CA302		MOTORCYCLE FASTENERS	
Assortment contents listed below			
ESW4	20 qty	1/4" Ext. Star Washers	
ESW5	10	5/16" Ext. Star Washers	
M8406016	5	M6 x 16 Pan x Rec Screws	
M8406020	5	M6 x 20 Pan x Rec Screws	
M8406030	5	M6 x 30 Pan x Rec Screws	
M8406040	5	M6 x 40 Pan x Rec Screws	
M8406050	5	M6 x 50 Pan x Rec Screws	
M8406070	5	M6 x 70 Pan x Rec Screws	
M8406080	5	M6 x 80 Pan x Rec Screws	
M91206010	5	M6 x 10 Socket Hd Cap Screw	
M91206016	5	M6 x 16 Socket Hd Cap Screw	
M91206020	5	M6 x 20 Socket Hd Cap Screw	
M91206025	5	M6 x 25 Socket Hd Cap Screw	
M91206035	5	M6 x 35 Socket Hd Cap Screw	
M91206040	3	M6 x 40 Socket Hd Cap Screw	
M91206050	3	M6 x 50 Socket Hd Cap Screw	
M91206060	3	M6 x 60 Socket Hd Cap Screw	
M91206070	3	M6 x 70 Socket Hd Cap Screw	
M91206080	3	M6 x 80 Socket Hd Cap Screw	
M933060012	10	6 x 12mm GR8.8 Set Screws	
M933060016	10	6 x 16mm GR8.8 Set Screws	
M933060020	10	6 x 20mm GR8.8 Set Screws	
M933060040	10	6 x 40mm GR8.8 Set Screws	
M933080025	2	8 x 25mm GR8.8 Set Screws	
M933080035	2	8 x 35mm GR8.8 Set Screws	
M933080050	2	8 x 50mm GR8.8 Set Screws	
M93406100	20	M6 x 1.00 Metric Hex Nuts	
M93408125	20	M8 x 1.25 Metric Hex Nuts	

Bulk Packs: page 133

CA330		FLAT STEEL WASHERS	
IMPERIAL & METRIC			
C330-1	10 /pk	3/16"	
C330-2	50	1/4"	
C330-3	50	5/16"	
C330-4	25	3/8"	
C330-5	30	M10	
C330-6	15	7/16"	
C330-7	20	1/2"	
C330-8	15	9/16"	
C330-9	15	5/8"	
C330-10	10	3/4"	

Bulk Packs: page 133

CA350		SELF-TAPPING SCREWS	
HEX HEAD			
C350-1	25 / pack	6G x 1/2"	
C350-2	25	6G x 3/4"	
C350-3	25	6G x 1"	
C350-4	25	8G x 1/2"	
C350-5	25	8G x 3/4"	
C350-6	25	8G x 1"	
C350-7	25	10G x 1/2"	
C350-8	25	10G x 3/4"	
C350-9	25	10G x 1"	
C350-10	25	12G x 3/4"	
C350-11	25	12G x 1"	
C350-12	25	14G x 5/8"	
C350-13	25	14G x 3/4"	
C350-14	25	14G x 1"	

Bulk Packs: page 129

CA360		SELF-LOCKING NUTS, NYLON INSERT	
METRIC, UNC & UNF			
C360-1	20 / pack	1/4" UNF	
C360-2	20	5/16" UNF	
C360-3	20	3/8" UNF	
C360-4	15	1/4" UNC	
C360-5	15	5/16" UNC	
C360-6	15	3/8" UNC	
C360-7	12	6mm	
C360-8	12	8mm	
C360-9	12	10mm	
C360-10	25	1/4" Flat Washers	

Bulk Packs: p148/152

CA365		UNF BOLTS, SET SCREWS & NUTS	
HIGH TENSILE			
C365-1	20 / pack	1/4 x 1/2" Set Screws	
C365-2	20	1/4 x 5/8" Set Screws	
C365-3	20	1/4 x 1" Set Screws	
C365-4	10	1/4 x 1-1/2" Set Screws	
C365-5	15	5/16 x 3/4" Set Screws	
C365-6	20	5/16 x 1" Set Screws	
C365-7	15	5/16 x 1-1/4" Bolts	
C365-8	10	5/16 x 1-1/2" Bolts	
C365-9	10	5/16 x 2" Bolts	
C365-10	10	3/8 x 1" Set Screws	
C365-11	10	3/8 x 1-1/2" Bolts	
C365-12	5	3/8 x 2" Bolts	
C365-13	10	7/16 x 1-1/4" Set Screws	
C365-14	5	7/16 x 2" Bolts	
C365-15	5	1/2 x 1-1/2" Bolts	
C365-16	5	1/2 x 2" Bolts	
C365-17	75	1/4" Plain Nuts	
C365-18	50	5/16" Plain Nuts	
C365-19	25	3/8" Plain Nuts	
C365-20	15	7/16" Plain Nuts	
C365-21	10	1/2" Plain Nuts	

Bulk Packs: page 151

CA370 UNC BOLTS, SET SCREWS & NUTS

HIGH TENSILE

C370-1	20 / pack	1/4 x 1/2" Set Screws	
C370-2	20	1/4 x 5/8" Set Screws	
C370-3	20	1/4 x 1" Set Screws	
C370-4	10	1/4 x 1-1/2" Set Screws	
C370-5	15	5/16 x 3/4" Set Screws	
C370-6	20	5/16 x 1" Set Screws	
C370-7	10	5/16 x 1-1/4" Bolts	
C370-8	10	5/16 x 1-1/2" Bolts	
C370-9	10	5/16 x 2" Bolt	
C370-10	10	3/8 x 1" Set Screws	
C370-11	10	3/8 x 1-1/2" Bolts	
C370-12	5	3/8 x 2" Bolts	
C370-13	10	7/16 x 1-1/2" Set Screws	
C370-14	5	7/16 x 2" Bolts	
C370-15	5	1/2 x 1-1/2" Bolts	
C370-16	5	1/2 x 2" Bolts	
C370-17	70	1/4" Plain Nuts	
C370-18	60	5/16" Plain Nuts	
C370-19	30	3/8" Plain Nuts	
C370-20	15	7/16" Plain Nuts	
C370-21	10	1/2" Plain Nuts	

Bulk Packs: page 150

CA380 SPEED NUTS

'U' & FLAT TYPES

C380-1	20 / pack	8G Screw 31/32 x 7/16"	
C380-2	20	10G Screw 13/16 x 1/2"	
C380-3	20	6G Screw 21/32 x 7/16"	
C380-4	20	10G Screw 1/2 x 11/16"	
C380-5	50	1/8" Stud 1/2 x 5/16"	
C380-6	50	3/32" Stud 7/16 x 1/4"	
C380-7	50	3/16" UNC 5/8 x 3/8"	
C380-8	50	3/16" Stud 5/8 x 3/8"	
C380-9	20	10G Screw 15/32 x 11/16"	
C380-10	20	8G Screw 21/32 x 7/16"	
C380-11	20	8G Screw 13/32 x 11/32"	
C380-12	50	10G Screw 21/32 x 13/32"	

Bulk Packs: page 130

CA390 FIBRE WASHERS

1/16" THICK

C390-1	45 / pack	5/32 x 5/16"	
C390-2	45	3/16 x 3/8"	
C390-3	35	7/32 x 7/16"	
C390-4	55	1/4 x 7/16"	
C390-5	50	5/16 x 1/2"	
C390-6	45	3/8 x 5/8"	
C390-7	25	7/16 x 11/16"	
C390-8	25	1/2 x 3/4"	
C390-9	20	9/16 x 13/16"	
C390-10	20	5/8 x 7/8"	
C390-11	20	11/16 x 15/16"	
C390-12	20	3/4 x 1"	

Bulk Packs: page 133

CA400 FIBRE WASHERS





1/32" THICK

C400-1	30 / pack	1/8 x 5/16"	
C400-2	30	3/16 x 1/2"	
C400-3	50	1/4 x 9/16"	
C400-4	50	5/16 x 5/8"	
C400-5	50	3/8 x 3/4"	
C400-6	50	7/16 x 13/16"	
C400-7	50	1/2 x 7/8"	
C400-8	30	9/16 x 15/16"	
C400-9	30	5/8 x 1"	
C400-10	15	11/16 x 1-1/16"	
C400-11	15	3/4 x 1-1/8"	
C400-12	10	13/16 x 1-3/16"	
C400-13	10	7/8 x 1-3/8"	
C400-14	10	1 x 1-1/2"	

Bulk Packs: page 133

CA407 'O' RINGS

IMPERIAL, 70 SHORE

		I.D.	SECTION		
C407-1	20 / pack	1/8"	1/16"		
C407-2	20	3/16"	1/16"		
C407-3	20	1/4"	1/16"		
C407-4	20	5/16"	1/16"		
C407-5	20	3/8"	1/16"		
C407-6	20	1/2"	1/16"		
C407-7	15	3/8"	3/32"		
C407-8	15	7/16"	3/32"		
C407-9	15	1/2"	3/32"		
C407-10	15	9/16"	3/32"		
C407-11	15	5/8"	3/32"		
C407-12	15	11/16"	3/32"		
C407-13	15	3/4"	3/32"		
C407-14	15	13/16"	3/32"		
C407-15	15	7/8"	3/32"		
C407-16	10	3/4"	1/8"		
C407-17	10	13/16"	1/8"		
C407-18	10	7/8"	1/8"		
C407-19	10	15/16"	1/8"		
C407-20	10	1"	1/8"		
C407-21	10	1-1/16"	1/8"		
C407-22	10	1-1/8"	1/8"		
C407-23	10	1-3/16"	1/8"		
C407-24	10	1-1/4"	1/8"		
C407-25	10	1-5/16"	1/8"		
C407-26	10	1-3/8"	1/8"		
C407-27	10	1-7/16"	1/8"		
C407-28	10	1-1/2"	1/8"		
C407-29	10	1-5/8"	1/8"		
C407-30	10	1-3/4"	1/8"		
C407-31	10	1-7/8"	1/8"		
C407-32	10	2"	1/8"		

Bulk Packs: page 128

REPLACEMENT PACKS

REPLACEMENT PACKS

REPLACEMENT
PACKS

CA408		'O' RINGS	
METRIC, 70 SHORE			
		I.D.	SECTION
C408-1	20 / pack	3mm	2mm
C408-2	20	5mm	2mm
C408-3	20	6mm	2mm
C408-4	20	8mm	2mm
C408-5	20	10mm	2mm
C408-6	20	13mm	2mm
C408-7	15	10mm	2.5mm
C408-8	15	12mm	2.5mm
C408-9	15	14mm	2.5mm
C408-10	15	15mm	2.5mm
C408-11	15	16mm	2.5mm
C408-12	15	18mm	2.5mm
C408-13	15	20mm	2.5mm
C408-14	15	21mm	2.5mm
C408-15	15	22mm	2.5mm
C408-16	10	18mm	3.5mm
C408-17	10	20mm	3.5mm
C408-18	10	22mm	3.5mm
C408-19	10	23mm	3.5mm
C408-20	10	25mm	3.5mm
C408-21	10	27mm	3.5mm
C408-22	10	28mm	3.5mm
C408-23	10	30mm	3.5mm
C408-24	10	31mm	3.5mm
C408-25	10	32mm	3.5mm
C408-26	10	34mm	3.5mm
C408-27	10	36mm	3.5mm
C408-28	10	38mm	3.5mm
C408-29	10	41mm	3.5mm
C408-30	10	44mm	3.5mm
C408-31	10	46mm	3.5mm
C408-32	10	50mm	3.5mm

Bulk Packs: page 128

CA409		'O' RINGS – SPLICING KIT	
IMPERIAL			
<i>Assortment contents listed below</i>			
1 qty	0.070 x 36"		
1	0.103 x 36"		
1	0.139 x 36"		
1	0.210 x 36"		
1	0.275 x 36"		

CA410		'O' RINGS – SPLICING KIT	
METRIC			
<i>Assortment contents listed below</i>			
1 qty	1.5 x 900mm		
1	2.0 x 900mm		
1	2.5 x 900mm		
1	3.0 x 900mm		
1	3.5 x 900mm		
1	4.0 x 900mm		
1	5.0 x 900mm		
1	6.0 x 900mm		
1	8.5 x 900mm		

CA411		AIRCONDITIONING 'O' RINGS	
SUITS R134A GAS. HMBR (GREEN), IMPERIAL, 70 SHORE			
		I.D.	SECTION
C411-1	20 / pack	3/16"	1/16"
C411-2	20	1/4"	1/16"
C411-3	15	3/8"	1/16"
C411-4	15	7/16"	1/16"
C411-5	15	9/16"	1/16"
C411-6	15	11/16"	1/16"
C411-7	15	7/16"	3/32"
C411-8	10	9/16"	3/32"
C411-9	10	5/8"	3/32"
C411-10	10	3/4"	3/32"

Bulk Packs: page 128

CA420		SELF-TAPPING SCREWS	
RAISED & PAN HEAD			
C420-1	25 / pack	6G x 3/4" Raised Head	
C420-2	25	6G x 1" Raised Head	
C420-3	25	8G x 3/4" Raised Head	
C420-4	20	8G x 1" Raised Head	
C420-5	50	6G x 1/2" Pan Head	
C420-6	50	7G x 1/2" Pan Head	
C420-7	50	10G x 1" Pan Head	
C420-8	25	12G x 1" Pan Head	
C420-9	50	8G x 3/8" Pan Head	
C420-10	50	8G x 5/8" Pan Head	
C420-11	25	10G x 1/2" Pan Head	
C420-12	25	10G x 3/4" Pan Head	

Bulk Packs: page 130

CA430		SELF-TAPPING SCREWS	
RAISED, HEX & PAN HEAD			
C430-1	25 / pack	14G x 5/8" Hex Head	
C430-2	25	14G x 3/4" Hex Head	
C430-3	50	10G x 3/8" Hex Head	
C430-4	50	10G x 1/2" Hex Head	
C430-5	50	4G x 1/4" Pan Head	
C430-6	25	10G x 7/8" Pan Head	
C430-7	25	8G x 1" Pan Head	
C430-8	25	8G x 3/8" Pan Head	
C430-9	25	14G x 1/2" Pan Head	
C430-10	25	14G x 5/8" Pan Head	
C430-11	25	14G x 3/4" Pan Head	
C430-12	25	14G x 5/8" Raised Head	
C430-13	30	8G x 1/2" Rsd Hd Phillips	
C430-14	25	8G x 1-1/2" Rsd Hd Phillips	

Bulk Packs: page 130

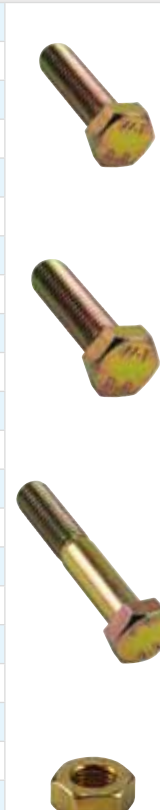
CA431		METRIC BOLTS, SET SCREWS & NUTS	
HIGH TENSILE, GR8.8			
C431-1	20 / pack	M4 x 20mm Set Screws	
C431-2	20	M4 x 35mm Set Screws	
C431-3	10	M5 x 25mm Set Screws	
C431-4	10	M5 x 35mm Set Screws	
C431-5	20	M6 x 16mm Set Screws	
C431-6	20	M6 x 20mm Set Screws	
C431-7	20	M6 x 25mm Set Screws	
C431-8	15	M6 x 40mm Set Screws	
C431-9	12	M8 x 20mm Set Screws	
C431-10	12	M8 x 25mm Set Screws	
C431-11	10	M8 x 35mm Set Screws	
C431-12	10	M8 x 40mm Set Screws	
C431-13	8	M8 x 50mm Bolt	
C431-14	8	M10 x 25mm Set Screws	
C431-15	6	M10 x 35mm Set Screws	
C431-16	4	M10 x 50mm Set Screws	
C431-17	3	M12 x 45mm (with nuts)	
C431-18	60	M4 x 0.7mm Nuts	
C431-19	50	M5 x 0.8mm Nuts	
C431-20	50	M6 x 1.0mm Nuts	
C431-21	40	M8 x 1.25mm Nuts	
C431-22	20	M10 x 1.5mm Nuts	

Bulk Packs: p142-143

CA480		METRIC BOLTS, SET SCREWS & NUTS	
ISO & FINE PITCH, HIGH TENSILE, GR8.8			
C480-1	20 / pack	M4 x 20 x 0.7mm	
C480-2	20	M4 x 35 x 0.7mm	
C480-3	10	M5 x 25 x 0.8mm	
C480-4	10	M5 x 35 x 0.8mm	
C480-5	20	M6 x 16 x 1.00mm	
C480-6	20	M6 x 20 x 1.00mm	
C480-7	20	M6 x 25 x 1.00mm	
C480-8	10	M6 x 40 x 1.00mm	
C480-9	10	M8 x 20 x 1.00mm	
C480-10	10	M8 x 25 x 1.00mm	
C480-11	10	M8 x 35 x 1.00mm	
C480-12	10	M8 x 40 x 1.00mm	
C480-13	8	M10 x 25 x 1.25mm	
C480-14	6	M10 x 35 x 1.25mm	
C480-15	4	M10 x 50 x 1.25mm	
C480-16	3	M12 x 45 x 1.25 & Nuts	
C480-17	60	M4 x 0.7mm Nuts	
C480-18	50	M5 x 0.8mm Nuts	
C480-19	50	M5 x 0.9 Nuts Special Pitch	
C480-20	56	M6 x 1.00mm Nuts	
C480-21	50	M8 x 1.00mm Nuts	
C480-22	20	M10 x 1.25mm Nuts	

Bulk Packs: p142-146

CA495		HEX FLANGE HEAD SET SCREWS & NUTS	
METRIC, HIGH TENSILE, ISO & FINE PITCH, GR8.8			
C495-1	20 / pack	M5 x 16mm	
C495-2	20	M5 x 25mm	
C495-3	20	M6 x 16mm	
C495-4	20	M6 x 20mm	
C495-5	20	M6 x 25mm	
C495-6	20	M6 x 30mm	
C495-7	15	M6 x 40mm	
C495-8	15	M8 x 16mm	
C495-9	15	M8 x 20mm	
C495-10	12	M8 x 25mm	
C495-11	5	M8 x 30mm	
C495-12	10	M8 x 40mm	
C495-13	7	M8 x 50mm	
C495-14	8	M10 x 25 x 1.25mm	
C495-15	6	M10 x 35 x 1.25mm	
C495-16	6	M10 x 40 x 1.25mm	
C495-17	5	M10 x 50 x 1.25mm	
C495-18	40	M5 x 0.8mm (8mm AF)	
C495-19	95	M6 x 1.00mm (10mm AF)	
C495-20	71	M8 x 1.25mm (12mm AF)	
C495-21	25	M10 x 1.25mm (14mm AF)	

Bulk Packs: p145-148

CA500		SPACING WASHERS STEEL	
C500-1	50 / pack	1/4 x 9/16"	
C500-2	50	5/16 x 11/16"	
C500-3	50	3/8 x 3/4"	
C500-4	50	7/16 x 13/16"	
C500-5	50	1/2 x 7/8"	
C500-6	50	9/16 x 15/16"	
C500-7	50	5/8 x 1"	
C500-8	45	11/16 x 1-1/16"	
C500-9	45	3/4 x 1-1/8"	
C500-10	30	13/16 x 1-3/16"	
C500-11	30	7/8 x 1-1/4"	
C500-12	15	15/16 x 1-3/8"	
C500-13	15	1 x 1-1/2"	
C500-14	15	1-1/8 x 1-3/4"	

Bulk Packs page: 134

CA502		RIVETS BLIND ALUMINIUM	
C502-1	10 / pack	3/32" Short x 0.290	
C502-2	50	1/8" Short x 0.290	
C502-3	50	1/8" Medium x 0.400	
C502-4	40	1/8" Long x 0.500	
C502-5	50	5/32" Short x 0.290	
C502-6	25	5/32" Medium x 0.450	
C502-7	25	5/32" Long x 0.500	
C502-8	25	3/16" Short x 0.350	
C502-9	25	3/16" Medium x 0.490	
C502-10	25	3/16" Long x 0.570	



Bulk Packs: page 128



REPLACEMENT PACKS

REPLACEMENT PACKS

REPLACEMENT
PACKS

CA505		RIVET NUT INSERTS	
STEEL			
C505-1	10 / pack	M4 ISO	
C505-2	10	M5 ISO	
C505-3	10	M6 ISO	
C505-4	10	M8 ISO	
C505-5	10	M10 ISO	



CA510		STAR WASHERS	
INTERNAL & EXTERNAL			
C510-1	50 / pack	3/16" External Tooth	  
C510-2	50	1/4" External Tooth	
C510-3	50	5/16" External Tooth	
C510-4	50	3/8" External Tooth	
C510-5	20	7/16" External Tooth	
C510-6	15	1/2" External Tooth	
C510-7	10	5/8" External Tooth	
C510-8	50	3/16" Internal Tooth	
C510-9	50	1/4" Internal Tooth	
C510-10	60	5/16" Internal Tooth	
C510-11	50	3/8" Internal Tooth	
C510-12	20	7/16" Internal Tooth	
C510-13	15	1/2" Internal Tooth	
C510-14	10	5/8" Internal Tooth	

CA520		SPRING WASHERS	
IMPERIAL & METRIC			
C520-1	50 / pack	5/32" (4mm)	 
C520-2	100	3/16" (5mm)	
C520-3	50	6mm	
C520-4	100	1/4"	
C520-5	100	5/16" (8mm)	
C520-6	50	3/8"	
C520-7	25	7/16"	
C520-8	25	12mm	
C520-9	25	1/2"	
C520-10	5 (each)	5/8" (16mm), & 3/4"	

Bulk Packs: page 134

CA530		SELF-DRILLING SCREWS	
MUSHROOM, WAFER & HEX HEAD			
C530-1	50 / pack	8G x 12mm Mushroom Hd	
C530-2	50	8G x 16mm Mushroom Hd	
C530-3	50	8G x 20mm Mushroom Hd	
C530-4	50	8G x 25mm Mushroom Hd	
C530-5	50	10G x 16mm Wafer Head	
C530-6	50	10G x 22mm Wafer Head	
C530-7	50	10G x 30mm Wafer Head	
C530-8	50	10G x 16mm Hex Head	

Bulk Packs: page 129

CA540		SELF-TAPPING SCREWS	
RAISED & PAN HEAD, PHILLIPS, NICKEL PLATED			
C540-1	40 / pack	4G x 5/8" Raised Head	  
C540-2	50	6G x 1/2" Raised Head	
C540-3	40	6G x 1" Raised Head	
C540-4	40	8G x 3/8" Raised Head	
C540-5	40	6G x 3/4" Raised Head	
C540-6	50	8G x 1/2" Raised Head	
C540-7	20	8G x 1" Raised Head	
C540-8	20	8G x 1-1/4" Raised Head	
C540-9	20	8G x 1-1/2" Raised Head	
C540-10	20	10G x 3/4" Raised Head	
C540-11	50	6G x 3/8" Pan Head	
C540-12	30	8G x 1/2" Pan Head	
C540-13	20	10G x 1/2" Pan Head	

*For Cup Washers see CA550.
Pack No: C550-14, C550-15 & C550-16*

Bulk Packs: p130-132

CA550		SELF-TAPPING SCREWS	
PAN & RAISED HEAD, SLOTTED, ZINC PLATED			
C550-1	50 / pack	6G x 3/4" Raised Head	  
C550-2	50	6G x 1" Raised Head	
C550-3	25	8G x 3/4" Raised Head	
C550-4	25	8G x 1" Raised Head	
C550-5	25	10G x 1" Pan Head	
C550-6	50	6G x 1/4" Pan Head	
C550-7	50	6G x 1/2" Pan Head	
C550-8	50	7G x 1/2" Pan Head	
C550-9	50	8G x 3/8" Pan Head	
C550-10	50	8G x 5/8" Pan Head	
C550-11	35	10G x 1/2" Pan Head	
C550-12	30	10G x 3/4" Pan Head	
C550-13	20	12G x 1" Pan Head	
C550-14	40	No.6 Cup Washers	
C550-15	40	No.8 Cup Washers	
C550-16	20	No.10 Cup Washers	

Bulk Packs: p130-132

CA560		SELF-TAPPING SCREWS	
PAN HEAD, SLOTTED, ZINC PLATED			
C560-1	50 / pack	6G x 1/2"	
C560-2	50	6G x 3/4"	
C560-3	50	6G x 1"	
C560-4	50	6G x 1-1/2"	
C560-5	50	8G x 1/2"	
C560-6	50	8G x 3/4"	
C560-7	50	8G x 1"	
C560-8	50	10G x 1-1/2"	

Bulk Packs: page 130

CA570		ANTI-THEFT SCREWS	
<i>Assortment contents listed below</i>			
NPS7	100 qty	10G x 3/4 Self-Tap One Way	 
CWS30	200	6mm Flat Washers Z/P	
CBP76	10	M6 Short Captive Nuts	
SNU0537	20	No.10 Spire Screw	
NPS5	100	M6 x 20 One Way Screws	
PN2	100	M6 x 1.00 Metric Hex Nut	

CA576 FLAT STEEL WASHERS

IMPERIAL & METRIC		
C576-1	150 / pack	3/16"
C576-2	150	1/4"
C576-3	75	5/16"
C576-4	40	3/8"
C576-5	25	7/16"
C576-6	25	1/2"
C576-7	10	5/8"
C576-8	5 (each)	3/4" & 20mm
C576-9	150	6mm
C576-10	30	10mm
C576-11	20	12mm
C576-12	10	9/16"

Bulk Packs: p133-134

CA600 FLAT STEEL HEAVY DUTY WASHERS

C600-1	150 / pack	3/16 x 1/2" x 18G
C600-2	150	1/4 x 9/16" x 14G
C600-3	100	5/16 x 5/8" x 14G
C600-4	75	3/8 x 3/4" x 14G
C600-5	75	7/16 x 7/8" x 14G
C600-6	25	1/2 x 1" x 14G
C600-7	15	5/8 x 1-3/8" x 14G
C600-8	15	3/4 x 1-1/2" x 14G

Bulk Packs: page 134

CA648 SPRING WASHERS

IMPERIAL & METRIC		
C648-1	200 / pack	3/16" (5mm)
C648-2	150	1/4"
C648-3	75	5/16" (8mm)
C648-4	40	3/8"
C648-5	25	7/16"
C648-6	20	1/2"
C648-7	10	5/8" (16mm)
C648-8	3	20mm
C648-9	200	5/32" (4mm)
C648-10	150	6mm
C648-11	40	10mm
C648-12	20	12mm

Bulk Packs: page 134

CA800 SPLIT PINS

ZINC PLATED		
C800-1	150 / pack	1.6 x 22mm
C800-2	100	1.6 x 36mm
C800-3	150	2.0 x 22mm
C800-4	100	2.0 x 36mm
C800-5	72	2.5 x 25m
C800-6	72	2.5 x 45mm
C800-7	50	7/64 x 1-1/4"
C800-8	36	3.2 x 50mm
C800-9	40	9/64 x 1-3/4"
C800-10	25	4.0 x 45mm

Bulk Packs: page 131

CA825 FIBRE WASHERS

1/32" THICK		
C825-1	50 / pack	1/8 x 5/16"
C825-2	50	3/16 x 1/2"
C825-3	100	1/4 x 9/16"
C825-4	100	5/16 x 5/8"
C825-5	100	3/8 x 3/4"
C825-6	100	7/16 x 13/16"
C825-7	100	1/2 x 7/8"
C825-8	50	9/16 x 15/16"
C825-9	50	5/8 x 1"
C825-10	25	11/16 x 1-1/16"
C825-11	25	3/4 x 1-1/8"
C825-12	25	13/16 x 1-3/16"
C825-13	25	7/8 x 1-3/8"
C825-14	25	1 x 1-1/2"

Bulk Packs: page 133

CA1008 SPRING WASHERS

SQUARE SECTION, ZINC PLATED		
C1008-1	150 / pack	3/16"
C1008-2	250	1/4"
C1008-3	250	5/16"
C1008-4	100	3/8"
C1008-5	50	7/16"
C1008-6	50	1/2"
C1008-7	30	5/8"
C1008-8	15	3/4"

Bulk Packs: page 134

CA1152 SPLIT PINS

ZINC PLATED		
C1152-1	100 / pack	1.6 x 22mm
C1152-2	100	2.0 x 22mm
C1152-3	100	2.0 x 36mm
C1152-4	100	2.5 x 25mm
C1152-5	100	2.5 x 32mm
C1152-6	100	7/64 x 2"
C1152-7	100	3.2 x 32mm
C1152-8	100	3.2 x 45mm

Bulk Packs: page 131

CA1200 SELF-TAPPING SCREWS

BLACK ZINC, PAN & RAISED HEAD, PHILLIPS		
C1200-1	50 / pack	6G x 1/2" Pan Head
C1200-2	50	6G x 3/4" Pan Head
C1200-3	30	6G x 1" Pan Head
C1200-4	30	8G x 3/8" Pan Head
C1200-5	30	8G x 5/8" Pan Head
C1200-6	30	8G x 3/4" Pan Head
C1200-7	30	8G x 1" Pan Head
C1200-8	20	8G x 1-1/2" Pan Head
C1200-9	30	10G x 1/2" Pan Head
C1200-10	20	10G x 3/4" Pan Head
C1200-11	20	10G x 1" Pan Head
C1200-12	15	12G x 1" Pan Head
C1200-13	30	6G x 1" Raised Head
C1200-14	30	8G x 3/4" Raised Head

Bulk Packs: page 129

REPLACEMENT PACKS

REPLACEMENT
PACKS

CA1320 BALL JOINTS		
CUP TYPE STEEL, ZINC PLATED		
<i>Assortment contents listed below</i>		
A1000	2 qty	10/32" UNF Spring Loaded
A1002	2	1/4-28" UNF Spring Loaded
A1003	2	5/16-24 UNF Spring Loaded
D1209C	2	1/4-20" UNC Light Weight
D1209F	2	1/4-28" UNF Light Weight
DS1209C	2	1/4" UNC Light In-Line
DS1209F	2	1/4" UNF Light In-Line
SP1000	2	10/32" UNF Heavy Duty
SP1002	2	1/4-28" TPI Heavy Duty
SP1003	2	5/16-24" TPI Heavy Duty

Bulk Packs: page 217

CA1411 EXPANSION PLUGS		
CUP TYPE STEEL, ZINC PLATED		
C1411-1	5 / pack	18mm
C1411-2	5	20mm
C1411-3	5	22mm
C1411-4	5	25mm
C1411-5	5	27mm
C1411-6	5	28mm
C1411-7	5	30mm
C1411-8	5	35mm
C1411-9	2	40mm
C1411-10	2	41.5m
C1411-11	2	45mm
C1411-12	2	46.5mm

CA1412 BRASS OLIVES		
SUITS COPPER & NYLON TUBE		
C1412-1	20 / pack	101 Suits 1/8" Copper
C1412-2	30	102 Suits 3/16" Copper
C1412-3	60	103 Suits 1/4" Copper
C1412-4	60	104 Suits 5/16" Copper
C1412-5	40	105 Suits 3/8" Copper
C1412-6	20	107 Suits 1/2" Copper
C1412-7	10	102N Suits 3/16" Nylon
C1412-8	10	103N Suits 1/4" Nylon
C1412-9	10	104N Suits 5/16" Nylon
C1412-10	10	105N Suits 3/8" Nylon
C1412-11	30	110 Suits 6mm Copper Tube
C1412-12	30	110N Suits 6mm Nylon Tube

Bulk Packs: p153-155

CA1416 SOCKET SET (GRUB) SCREWS		
METRIC & IMPERIAL, BSW, HARDENED		
C1416-1	20 / pack	3/16 x 3/16" BSW
C1416-2	12	3/16 x 3/8" BSW
C1416-3	12	1/4 x 1/4" BSW
C1416-4	10	1/4 x 1/2" BSW
C1416-5	10	5/16 x 5/16" BSW
C1416-6	10	5/16 x 5/8" BSW
C1416-7	8	3/8 x 5/8" BSW
C1416-8	8	3/8 x 1" BSW
C1416-9	20	5 x 5mm
C1416-10	12	5 x 10mm
C1416-11	12	6 x 6mm
C1416-12	10	6 x 12mm
C1416-13	10	8 x 8mm
C1416-14	10	8 x 16mm

CA1417 SOCKET HEAD CAP SCREWS		
METRIC, HIGH TENSILE		
C1417-1	10 / pack	5 x 10mm
C1417-2	6	5 x 25mm
C1417-3	6	5 x 35mm
C1417-4	10	6 x 10mm
C1417-5	6	6 x 16mm
C1417-6	6	6 x 20mm
C1417-7	6	6 x 25mm
C1417-8	6	6 x 40mm
C1417-9	6	8 x 16mm
C1417-10	6	8 x 20mm
C1417-11	6	8 x 25mm
C1417-12	6	8 x 35mm
C1417-13	6	8 x 40mm
C1417-14	4	10 x 25mm

Bulk Packs: p148-149

CA1418 SOCKET HEAD CAP SCREWS		
BSW, HIGH TENSILE		
C1418-1	10 / pack	3/16 x 1/2"
C1418-2	6	3/16 x 3/4"
C1418-3	6	3/16 x 1"
C1418-4	6	3/16 x 1-1/4"
C1418-5	10	1/4 x 1/2"
C1418-6	6	1/4 x 3/4"
C1418-7	6	1/4 x 1"
C1418-8	6	1/4 x 1-1/4"
C1418-9	6	1/4 x 1-1/2"
C1418-10	6	5/16 x 1/2"
C1418-11	6	5/16 x 3/4"
C1418-12	6	5/16 x 1"
C1418-13	6	5/16 x 1-1/4"
C1418-14	6	5/16 x 1-1/2"

Bulk Packs: page 130

CA1419 SOCKET HEAD CAP SCREWS		
COUNTERSUNK, HIGH TENSILE		
C1419-1	10 / pack	M4 x 16mm
C1419-2	10	M4 x 25mm
C1419-3	10	M5 x 16mm
C1419-4	10	M5 x 20mm
C1419-5	10	M5 x 25mm
C1419-6	10	M5 x 30mm
C1419-7	10	M6 x 16mm
C1419-8	10	M6 x 20mm
C1419-9	10	M6 x 25mm
C1419-10	10	M6 x 30mm
C1419-11	6	M8 x 16mm
C1419-12	6	M8 x 20mm
C1419-13	6	M8 x 25mm
C1419-14	6	M8 x 30mm

CA1420		BUTTON HEAD CAP SCREWS	
METRIC, HIGH TENSILE			
C1420-1	10 / pack	M4 x 16mm	
C1420-2	10	M4 x 25mm	
C1420-3	10	M5 x 16mm	
C1420-4	10	M5 x 20mm	
C1420-5	10	M5 x 25mm	
C1420-6	10	M5 x 30mm	
C1420-7	10	M6 x 16mm	
C1420-8	10	M6 x 20mm	
C1420-9	10	M6 x 25mm	
C1420-10	10	M6 x 30mm	
C1420-11	6	M8 x 16mm	
C1420-12	6	M8 x 20mm	
C1420-13	6	M8 x 25mm	
C1420-14	6	M8 x 30mm	

CA1421		ROLL PINS	
IMPERIAL			
C1421-1	40 / pack	1/16 x 1/2"	
C1421-2	20	3/32 x 1/2"	
C1421-3	20	3/32 x 5/8"	
C1421-4	20	3/32 x 3/4"	
C1421-5	20	3/32 x 1"	
C1421-6	20	1/8 x 3/8"	
C1421-7	20	1/8 x 1/2"	
C1421-8	20	1/8 x 5/8"	
C1421-9	20	1/8 x 3/4"	
C1421-10	20	1/8 x 7/8"	
C1421-11	20	1/8 x 1"	
C1421-12	20	5/32 x 1/2"	
C1421-13	20	5/32 x 1"	
C1421-14	20	3/16 x 3/4"	
C1421-15	20	3/16 x 1"	
C1421-16	20	3/16 x 1-1/4"	
C1421-17	20	3/16 x 1-1/2"	
C1421-18	20	1/4 x 1"	

CA1424		'E' CLIPS & RETAINER SPRINGS	
C1424-1	50 / pack	Springs 11/64" Shaft	
C1424-2	50	Springs 7/32" Shaft	
C1424-3	50	Springs 19/64" Shaft	
C1424-4	50	Springs 17/32" Shaft	
C1424-5	50	'E' Clips 3/32" Shaft	
C1424-6	50	'E' Clips 1/8" Shaft	
C1424-7	50	'E' Clips 5/32" Shaft	
C1424-8	50	'E' Clips 3/16" Shaft	
C1424-9	100	'E' Clips 1/4" Shaft	
C1424-10	50	'E' Clips 5/16" Shaft	
C1424-11	100	'E' Clips 3/8" Shaft	
C1424-12	30	'E' Clips 7/16" Shaft	
C1424-13	50	'E' Clips 1/2" Shaft	
C1424-14	10	'E' Clips 5/8" Shaft	

CA1435		ROLL PINS	
IMPERIAL, LARGE SIZES			
C1435-1	12 / pack	3/16 x 1-1/2"	
C1435-2	10	3/16 x 2"	
C1435-3	5	3/16 x 2-1/2"	
C1435-4	12	1/4 x 1"	
C1435-5	10	1/4 x 1-1/2"	
C1435-6	10	1/4 x 2"	
C1435-7	5	1/4 x 2-1/2"	
C1435-8	8	5/16 x 1-1/2"	
C1435-9	8	5/16 x 2"	
C1435-10	5	5/16 x 2-1/2"	
C1435-11	2	3/8 x 2"	
C1435-12	2	3/8 x 2-1/2"	

CA1460		POLYPROPYLENE WASHERS	
METRIC & IMPERIAL			
C1460-1	30 / pack	1/2 x 3/4"	
C1460-2	10	5/8 x 7/8"	
C1460-3	20	3/4 x 1-1/8"	
C1460-4	10	13/16 x 1-3/16"	
C1460-5	10	7/8 x 1-1/4"	
C1460-6	10	1 x 1-3/8"	
C1460-8	3	18 x 27mm	
C1460-9	10	30 x 38mm	
C1460-10	10	14 x 20mm	
C1460-11	10	0.530 x 3/4"	

CA1480		HEX SET SCREWS & NUTS	
METRIC GR8.8, ISO & FINE PITCH			
C431-8	15 / pack	M6 x 40 x 1.00mm	
C431-10	12	M8 x 25 x 1.25mm	
C431-11	10	M8 x 35 x 1.25mm	
C431-13	8	M8 x 50 x 1.25mm	
C480-12	10	M8 x 40 x 1.00mm	
C480-13	8	M10 x 25 x 1.25mm	
C480-14	6	M10 x 35 x 1.25mm	
C480-15	4	M10 x 50 x 1.25mm	
C480-16	3	M12 x 45 x 1.25 w/Nuts	
C431-21	40	M8 x 1.25mm Nuts	
C480-22	20	M10 x 1.25mm Nuts	

CA1630		SELF-TAPPING SCREWS	
ZINC PLATED			
C1630-1	100 / pack	6G x 3/4" Rsd.Hd. Phillips	
C1630-2	100	6G x 1" Rsd.Hd. Phillips	
C1630-3	100	8G x 3/4" Rsd.Hd. Phillips	
C1630-4	50	8G x 1" Rsd.Hd. Phillips	
C1630-5	50	10G x 1" Rsd.Hd. Phillips	
C1630-6	100	6G x 1/2" Pan Hd. Slot	
C1630-7	100	6G x 3/4" Pan Hd. Slot	
C1630-8	100	8G x 1/2" Pan Hd. Slot	
C1630-9	100	8G x 3/4" Pan Hd. Slot	
C1630-10	75	8G x 1" Pan Hd. Slot	

REPLACEMENT PACKS

REPLACEMENT PACKS

REPLACEMENT PACKS

CA1630		SELF-TAPPING SCREWS <i>Continued</i>	
ZINC PLATED			
C1630-11	100 / pack	10G x 1/2" Pan Hd. Slot	
C1630-12	75	10G x 3/4" Pan Hd. Slot	
C1630-13	50	10G x 1" Pan Hd. Slot	
C1630-14	30	10G x 1-1/2" Pan Hd. Slot	
C1630-15	50	8G x 1" Hex Hd. Slot	
C1630-16	100	10G x 1/2" Hex Hd. Slot	
C1630-17	50	10G x 3/4" Hex Hd. Slot	
C1630-18	50	12G x 1" Hex Hd. Slot	
C1630-19	50	14G x 3/4" Hex Hd. Slot	
C1630-20	100	6G Cup Washers	
C1630-21	100	8G Cup Washers	
C1630-22	50	10G Cup Washers	

Bulk Packs: p129-130

CA1660		COPPER WASHERS	
METRIC, 1mm THICK			
C1660-1	40 / pack	5 x 10mm	
C1660-2	40	6 x 12.5mm	
C1660-3	40	8 x 16mm	
C1660-4	40	10 x 20mm	
C1660-5	35	12 x 22mm	
C1660-6	20	14 x 24mm	
C1660-7	20	16 x 25mm	
C1660-8	15	20 x 30mm	
C1660-9	5	22 x 35mm	
C1660-10	5	24 x 38mm	

Bulk Packs: page 133

CA1670		FLAT WASHERS, EXTRA HEAVY DUTY	
IMPERIAL, UP TO 9G THICK			
C1670-1	80 / pack	3/16 x 9/16" x 16G	
C1670-2	80	1/4 x 3/4" x 16G	
C1670-3	60	5/16 x 7/8" x 14G	
C1670-4	40	3/8 x 7/8" x 14G	
C1670-5	40	7/16 x 1" x 10G	
C1670-6	15	1/2 x 1-1/4" x 10G	
C1670-7	5	5/8 x 1-3/4" x 9G	
C1670-8	5	3/4 x 2" x 9G	

Bulk Packs: page 134

CA1680		POLYPROPYLENE WASHERS	
IMPERIAL, 1/32" THICK			
C1680-1	30 / pack	1/8 x 5/16"	
C1680-2	30	5/32 x 3/8"	
C1680-3	30	3/16 x 1/2"	
C1680-4	30	7/32 x 1/2"	
C1680-5	50	1/4 x 9/16"	
C1680-6	50	5/16 x 5/8"	
C1680-7	50	3/8 x 3/4"	
C1680-8	50	7/16 x 13/16"	
C1680-9	50	1/2 x 7/8"	
C1680-10	30	9/16 x 15/16"	
C1680-11	30	5/8 x 1"	
C1680-12	15	11/16 x 1-1/16"	
C1680-13	15	3/4 x 1-1/8"	
C1680-14	10	13/16 x 1-3/16"	
C1680-15	10	7/8 x 1-3/8"	
C1680-16	10	1 x 1-1/2"	

CA1690		TAPER PINS	
SMALL SIZES			
C1690-1	10 / pack	No.0 x 1"	
C1690-2	10	No.0 x 1-1/2	
C1690-3	10	No.1 x 1"	
C1690-4	10	No.1 x 1-1/2"	
C1690-5	10	No.2 x 1"	
C1690-6	10	No.2 x 1-1/4	
C1690-7	10	No.2 x 1-1/2"	
C1690-8	10	No.2 x 2"	
C1690-9	10	No.3 x 3/4"	
C1690-10	10	No.3 x 1-1/2"	
C1690-11	10	No.3 x 2"	
C1690-12	10	No.4 x 1-1/2"	
C1690-13	10	No.4 x 2"	
C1690-14	10	No.5 x 2"	

Bulk Packs: page 132

CA1700		TAPER PINS	
LARGE SIZES			
<i>Assortment contents listed below</i>			
B-TP1064	2 qty	#10 x 4"	
B-TP1096	1	#10 x 6"	
B-TP440	4	#4 x 2-1/2"	
B-TP548	4	#5 x 3"	
B-TP632	4	#6 x 2"	
B-TP640	2	#6 x 2-1/2"	
B-TP648	2	#6 x 3"	
B-TP736	2	#7 x 2-1/4"	
B-TP748	2	#7 x 3"	
B-TP848	2	#8 x 3"	
B-TP864	2	#8 x 4"	
B-TP896	2	#8 x 6"	
B-TP964	2	#9 x 4"	
B-TP996	2	#9 x 6"	

Bulk Packs: page 132

CA1705		WOODRUFF KEYS	
METRIC			
C1705-1	10 / pack	2 x 10mm	
C1705-2	15	2.5 x 10mm	
C1705-3	15	3 x 10mm	
C1705-4	15	3 x 13mm	
C1705-5	15	3 x 16mm	
C1705-6	15	3 x 19mm	
C1705-7	8	4 x 13mm	
C1705-8	8	4 x 16mm	
C1705-9	8	4 x 19mm	
C1705-10	8	5 x 16mm	
C1705-11	8	5 x 19mm	
C1705-12	10	5 x 22mm	
C1705-13	8	6 x 22mm	
C1705-14	8	6 x 28mm	
C1705-15	5	8 x 28mm	
C1705-16	5	8 x 32mm	
C1705-17	3	10 x 32mm	

Bulk Packs: page 135

CA1710 SELF-TAPPING SCREWS		
PAN HEAD PHILLIPS, ZINC PLATED		
C1710-1	40 / pack	6G x 3/8"
C1710-2	30	6G x 1/2"
C1710-3	30	6G x 3/4"
C1710-4	30	8G x 3/8"
C1710-5	40	8G x 1/2"
C1710-6	30	8G x 3/4"
C1710-7	30	8G x 1"
C1710-8	25	8G x 1-1/2"
C1710-9	40	10G x 1/2"
C1710-10	30	10G x 3/4"
C1710-11	25	10G x 1"
C1710-12	20	10G x 1-1/2"
C1710-13	15	10G x 2"
C1710-14	30	12G x 1"

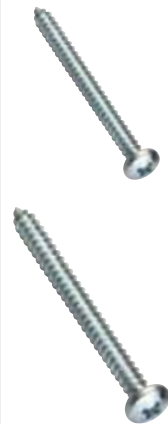

Bulk Packs: p129-130

CA1715 ROLL PINS		
METRIC, SMALL SIZES		
C1715-1	20 / pack	2.0mm x 12mm
C1715-2	20	2.0mm x 20mm
C1715-3	20	2.0mm x 25mm
C1715-4	20	2.5mm x 12mm
C1715-5	20	2.5mm x 16mm
C1715-6	20	2.5mm x 20mm
C1715-7	20	2.5mm x 25mm
C1715-8	20	3.0mm x 16mm
C1715-9	20	3.0mm x 20mm
C1715-10	20	3.0mm x 25mm
C1715-11	20	4.0mm x 16mm
C1715-12	20	4.0mm x 20mm
C1715-13	20	4.0mm x 25mm
C1715-14	20	5.0mm x 20mm
C1715-15	20	5.0mm x 25mm
C1715-16	20	6.0mm x 20mm
C1715-17	20	6.0mm x 25mm
C1715-18	20	6.0mm x 30mm



Bulk Packs: page 129

CA1720 SELF-TAPPING SCREWS		
BLACK MUSHROOM HEAD		
C1720-1	40 / pack	6G x 3/8"
C1720-2	30	6G x 1/2"
C1720-3	30	6G x 3/4"
C1720-4	30	8G x 3/8"
C1720-5	40	8G x 1/2"
C1720-6	30	8G x 3/4"
C1720-7	30	8G x 1"
C1720-8	25	8G x 1-1/2"
C1720-9	40	10G x 1/2"
C1720-10	30	10G x 3/4"
C1720-11	25	10G x 1"
C1720-12	20	10G x 1-1/2"
C1720-13	15	10G x 2"
C1720-14	30	12G x 1"



Bulk Packs: page 129

CA1725 ROLL PINS		
METRIC, LARGE SIZES		
C1725-1	10 / pack	5 x 30mm
C1725-2	10	5 x 40mm
C1725-3	10	6 x 40mm
C1725-4	10	6 x 50mm
C1725-5	5	6 x 60mm
C1725-6	10	8 x 30mm
C1725-7	8	8 x 40mm
C1725-8	5	8 x 50mm
C1725-9	5	8 x 60mm
C1725-10	5	10 x 40mm
C1725-11	2	10 x 50mm
C1725-12	2	10 x 60mm



Bulk Packs: page 129

CA1730 PANEL (BODY) WASHERS		
PANEL (BODY) STEEL & STAINLESS STEEL		
C1730-1	10 / pack	3/16 x 1" Steel
C1730-2	15	1/4 x 1-1/4" Steel
C1730-3	40	5/16 x 1-1/4" Steel
C1730-4	40	3/8 x 1-1/4" Steel
C1730-5	8	1/2 x 1-1/2" Steel
C1730-6	10	1/4 x 1-1/4" Stainless
C1730-7	10	5/16 x 1-1/4" Stainless
C1730-8	10	3/8 x 1-1/4" Stainless



Bulk Packs: page 134

CA1735 PLASTIC TRIM CLIPS & SCREW GROMMETS		
C1735-1	10 / pack	Black Xmas Tree Clip 16mm
C1735-2	10	Black Xmas Tree Clip 20mm
C1735-3	10	Black Xmas Tree Clip 18mm
C1735-4	20	Black Canoe Clip 14mm
C1735-5	10	Brown Canoe Clip 14mm
C1735-6	10	Black Canoe Clip 19mm
C1735-7	10	Door Panel Clip
C1735-8	10	Door Panel Clip Universal
C1735-9	20	Door Trim Bush
C1735-10	30	Weather Seal Clip
C1735-11	10	Screw Grom. 3/8 x 3/8" (10G)
C1735-12	10	Screw Grom. 6.9 x 7.3mm (6G)
C1735-13	10	Screw Grom. 3/8 x 3/8" (6G)
C1735-14	10	Screw Grom. 8.3 x 8.3mm (8G)



Bulk Packs: p119-123

CA1740 NYLON WASHERS		
METRIC & IMPERIAL		
C1740-1	20 / pack	12 x 20mm
C1740-2	20	14 x 22mm
C1740-3	20	16 x 24mm
C1740-4	20	18 x 28mm
C1740-5	10	25 x 35mm
C1740-6	20	1/2 x 3/4"
C1740-7	10	0.530 x 3/4"
C1740-8	10	5/8 x 15/16"
C1740-9	10	11/16 x 1"
C1740-10	10	3/4 x 1-1/8"
C1740-11	10	13/16 x 1-3/16"



Bulk Packs: page 134

REPLACEMENT PACKS

REPLACEMENT PACKS

CA1745 'R' CLIPS		
C1745-1	20 / pack	1/8 to 3/16" Shaft
C1745-2	20	3/16 to 1/4" Shaft
C1745-3	20	1/4 to 3/8" Shaft
C1745-4	20	5/16 to 1/2" Shaft
C1745-5	20	3/8 to 1/2" Shaft
C1745-6	10	7/16 to 3/4" Shaft
C1745-7	10	5/8 to 7/8" Shaft
C1745-8	4	3/4 to 1" Shaft



Bulk Packs: page 128

CA1750 SHIM STEEL WASHERS .006" THICK		
C1750-1	10 / pack	3/16 x 1/2"
C1750-2	30	1/4 x 9/16"
C1750-3	30	5/16 x 5/8"
C1750-4	30	3/8 x 3/4"
C1750-5	15	7/16 x 13/16"
C1750-6	15	1/2 x 7/8"
C1750-7	10	9/16 x 15/16"
C1750-8	10	5/8 x 1"
C1750-9	10	11/16 x 1-1/16"
C1750-10	10	3/4 x 1-1/8"
C1750-11	5	13/16 x 1-3/16"
C1750-12	5	7/8 x 1-1/4"
C1750-13	5	15/16 x 1-3/8"
C1750-14	5	1 x 1-1/2"



CA1755 FLAT STEEL WASHERS HIGH TENSILE, IMPERIAL		
C1755-1	25 / pack	1/4 x 5/8" x 16G
C1755-2	25	5/16 x 11/16" x 16G
C1755-3	25	3/8 x 13/16" x 16G
C1755-4	25	7/16 x 59/64" x 16G
C1755-5	25	1/2 x 1-1/16" x 11G
C1755-6	15	9/16 x 1-3/16" x 11G
C1755-7	10	5/8 x 1-5/16" x 10G
C1755-8	10	3/4 x 1-15/32" x 10G
C1755-9	10	7/8 x 1-3/4" x 9G
C1755-10	5	1 x 2" x 9G



Bulk Packs: page 134

CA1760 CIRCLIPS METRIC, EXTERNAL & INTERNAL		
C1760-1	20 / pack	6mm External
C1760-2	20	8mm External
C1760-3	20	10mm External
C1760-4	20	12mm External
C1760-5	20	14mm External
C1760-6	10	16mm External
C1760-7	5	20mm External
C1760-8	5	22mm External
C1760-9	5	25mm External
C1760-10	10	12mm Internal
C1760-11	5	16mm Internal
C1760-12	5	20mm Internal
C1760-13	5	22mm Internal
C1760-14	5	25mm Internal



Bulk Packs: page 124

CA1765 LOCK RINGS EXTERNAL SPN TYPE		
C1765-1	100 / pack	1.5mm
C1765-2	100	2mm
C1765-3	100	2.4mm
C1765-4	100	3mm
C1765-5	100	4mm
C1765-6	100	5mm
C1765-7	100	6mm
C1765-8	50	8mm
C1765-9	50	10mm
C1765-10	25	12mm



Bulk Packs: page 126

CA1770 ALUMINIUM WASHERS 1/16" THICK, IMPERIAL & METRIC		
C1770-1	30 / pack	1/4 x 1/2"
C1770-2	40	5/16 x 9/16"
C1770-3	30	3/8 x 5/8"
C1770-4	30	7/16 x 3/4"
C1770-5	20	1/2 x 7/8"
C1770-6	10	9/16 x 15/16"
C1770-7	20	5/8 x 1"
C1770-8	10	3/4 x 1-1/8"
C1770-9	5	7/8 x 1-1/4"
C1770-10	5	1 x 1-3/8"
C1770-11	30	5 x 10mm
C1770-12	30	6 x 12mm
C1770-13	30	10 x 20mm
C1770-14	20	12 x 22mm
C1770-15	5	20 x 30mm





Bulk Packs: page 132

CA1772 TORX® SECURITY MACHINE SCREWS METRIC, TX, PAN, ZINC PLATED		
C1772-1	25 / pack	M4 x 10mm
C1772-2	25	M4 x 16mm
C1772-3	25	M4 x 20mm
C1772-4	25	M4 x 25mm
C1772-5	25	M4 x 30mm
C1772-6	25	M5 x 10mm
C1772-7	25	M5 x 16mm
C1772-8	25	M5 x 20mm
C1772-9	25	M5 x 25mm
C1772-10	25	M5 x 30mm
C1772-11	25	M6 x 10mm
C1772-12	25	M6 x 16mm
C1772-13	25	M6 x 20mm
C1772-14	20	M6 x 25mm
C1772-15	20	M6 x 30mm





Torx® is a registered trademark of Camcar Textron Inc.

CA1774		TORX® SECURITY MACHINE SCREWS	
METRIC, TX, COUNTERSUNK, ZINC PLATED			
C1774-1	25 / pack	M4 x 10mm	
C1774-2	25	M4 x 16mm	
C1774-3	25	M4 x 20mm	
C1774-4	25	M4 x 25mm	
C1774-5	25	M5 x 10mm	
C1774-6	25	M5 x 16mm	
C1774-7	25	M5 x 20mm	
C1774-8	25	M5 x 25mm	
C1774-9	25	M6 x 10mm	
C1774-10	25	M6 x 16mm	
C1774-11	25	M6 x 20mm	
C1774-12	25	M6 x 25mm	
C1774-13	25	M6 x 30mm	

CA1776		TORX® SECURITY SELF-TAPPING SCREWS	
IMPERIAL, TX, PAN, ZINC PLATED			
C1776-1	25 / pack	6G x 1/2"	
C1776-2	25	6G x 5/8"	
C1776-3	25	6G x 3/4"	
C1776-4	25	6G x 1"	
C1776-5	25	6G x 1-1/4"	
C1776-6	25	6G x 1-1/2"	
C1776-7	25	8G x 1/2"	
C1776-8	25	8G x 5/8"	
C1776-9	25	8G x 3/4"	
C1776-10	25	8G x 1"	
C1776-11	25	8G x 1-1/4"	
C1776-12	25	8G x 1-1/2"	
C1776-13	25	10G x 1/2"	
C1776-14	25	10G x 5/8"	
C1776-15	25	10G x 3/4"	
C1776-16	25	10G x 1-1/4"	
C1776-17	25	10G x 1-1/2"	

CA1778		TORX® SECURITY SELF-TAPPING SCREWS	
IMPERIAL, TX, COUNTERSUNK, ZINC PLATED			
C1778-1	25 / pack	6G x 1/2"	
C1778-2	25	6G x 5/8"	
C1778-3	25	6G x 3/4"	
C1778-4	25	6G x 1-1/4"	
C1778-5	25	6G x 1-1/2"	
C1778-6	25	8G x 1/2"	
C1778-7	25	8G x 5/8"	
C1778-8	25	8G x 3/4"	
C1778-9	25	8G x 1"	
C1778-10	25	8G x 1-1/4"	
C1778-11	25	8G x 1-1/2"	
C1778-12	25	10G x 1/2"	
C1778-13	25	10G x 5/8"	
C1778-14	25	10G x 3/4"	
C1778-15	25	10G x 1"	
C1778-16	25	10G x 1-1/4"	
C1778-17	25	10G x 1-1/2"	

CA1780		STAR WASHERS	
METRIC, EXTERNAL & INTERNAL			
C1780-1	50 / pack	4mm External	
C1780-2	50	5mm External	
C1780-3	50	6mm External	
C1780-4	50	8mm External	
C1780-5	50	10mm External	
C1780-6	20	12mm External	
C1780-7	10	16mm External	
C1780-8	50	4mm Internal	
C1780-9	50	5mm Internal	
C1780-10	50	6mm Internal	
C1780-11	50	8mm Internal	
C1780-12	50	10mm Internal	
C1780-13	20	12mm Internal	
C1780-14	10	16mm Internal	

CA1782		TORX® SECURITY SELF-DRILLING SCREWS	
IMPERIAL, TX, PAN, ZINC PLATED			
C1782-1	25 / pack	6G x 1/2"	
C1782-2	25	6G x 5/8"	
C1782-3	25	6G x 3/4"	
C1782-4	25	6G x 1"	
C1782-5	25	8G x 1/2"	
C1782-6	25	8G x 5/8"	
C1782-7	25	8G x 3/4"	
C1782-8	25	8G x 1"	
C1782-9	25	8G x 1-1/4"	
C1782-10	25	8G x 1-1/2"	
C1782-11	25	10G x 5/8"	
C1782-12	25	10G x 3/4"	
C1782-13	25	10G x 1"	
C1782-14	25	10G x 1-1/4"	
C1782-15	25	10G x 1-1/2"	

CA1784		TORX® SECURITY BUTTON HEAD SCREWS	
METRIC, TX, ZINC PLATED			
C1784-1	25 / pack	4 x 16mm	
C1784-2	25	4 x 20mm	
C1784-3	25	5 x 10mm	
C1784-4	25	5 x 16mm	
C1784-5	20	5 x 20mm	
C1784-6	20	5 x 25mm	
C1784-7	20	5 x 30mm	
C1784-8	20	6 x 16mm	
C1784-9	20	6 x 20mm	
C1784-10	10	6 x 25mm	
C1784-11	10	8 x 16mm	
C1784-12	10	8 x 20mm	
C1784-13	10	8 x 25mm	
C1784-14	10	8 x 30mm	

REPLACEMENT
PACKS

Torx® is a registered trademark of Camcar Textron Inc.

REPLACEMENT PACKS

CA1786		MACHINE SCREWS	
METRIC, PHILLIPS, COUNTERSUNK, ZINC PLATED			
C1786-1	25 / pack	M3 x 20mm	
C1786-2	25	M3 x 50mm	
C1786-3	25	M4 x 16mm	
C1786-4	25	M4 x 25mm	
C1786-5	25	M4 x 35mm	
C1786-6	25	M4 x 50mm	
C1786-7	25	M5 x 20mm	
C1786-8	25	M5 x 25mm	
C1786-9	25	M5 x 35mm	
C1786-10	20	M5 x 50mm	
C1786-11	50	M6 x 16mm	
C1786-12	25	M6 x 20mm	
C1786-13	25	M6 x 25mm	
C1784-14	10	M8 x 30mm	

Bulk Packs: page 127

CA1790		DRAIN (SUMP) PLUG WASHERS	
ALUMINIUM, METRIC & IMPERIAL			
C1790-1	15 / pack	12 x 22 x 2.5mm	
C1790-2	10	14 x 24 x 2.5mm	
C1790-3	15	16 x 24 x 2.5mm	
C1790-4	15	18 x 28 x 2.5mm	
C1790-5	10	20 x 30 x 2.5mm	
C1790-6	10	22 x 32 x 2.5mm	
C1790-7	10	24 x 34 x 2.5mm	
C1790-8	15	1/2 x 7/8 x 3/32"	

Bulk Packs: page 132

CA1792		NYLON NUTS	
WING, DOME & HEX (PLASTIC)			
C1792-1	50 / pack	M5 x 0.8mm Hex Nuts	
C1792-2	40	M6 x 1mm Hex Nuts	
C1792-3	20	M8 x 1.25mm Hex Nuts	
C1792-4	25	M5 Wing Nuts	
C1792-5	25	M6 Wing Nuts	
C1792-6	15	M8 Wing Nuts	
C1792-7	40	M5 x 0.8 Hex Dome Nuts	
C1792-8	25	M6 x 1mm Hex Dome Nuts	
C1792-9	15	M8 x 1.25 Hex Dome Nuts	

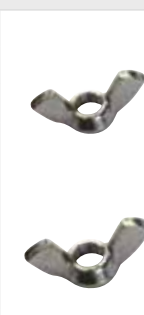
CA1794		WING NUTS	
METRIC, UNC, ZINC PLATED			
C1794-1	25 / pack	M4 x 0.7mm	
C1794-2	25	M5 x 0.8mm	
C1794-3	25	M6 x 1.00mm	
C1794-4	25	M8 x 1.25mm	
C1794-5	20	M10 x 1.50mm	
C1794-6	25	3/16 UNC	
C1794-7	25	1/4 UNC	
C1794-8	25	5/16 UNC	
C1794-9	20	3/8 UNC	

CA1796		COUPLING NUTS	
METRIC, UNC, HEX, ZINC PLATED			
C1796-1	10 / pack	5 x 20 x 0.8mm	
C1796-2	10	6 x 25 x 1.00mm	
C1796-3	10	8 x 25 x 1.25mm	
C1796-4	8	10 x 40 x 1.50mm	
C1796-5	6	12 x 40 x 1.75mm	
C1796-6	10	3/16 x 3/4" UNC	
C1796-7	10	1/4 x 1" UNC	
C1796-8	10	5/16 x 1" UNC	
C1796-9	10	3/8 x 1-1/2" UNC	
C1796-10	8	7/16 x 1-1/2" UNC	

CA1798		WING SCREWS	
METRIC, ZINC PLATED			
C1798-1	15 / pack	4 x 25mm	
C1798-2	15	5 x 25mm	
C1798-3	15	5 x 30mm	
C1798-4	10	6 x 16mm	
C1798-5	10	6 x 20mm	
C1798-6	10	6 x 25mm	
C1798-7	10	6 x 30mm	
C1798-8	10	6 x 40mm	

CA1800		STAINLESS STEEL ASSORTMENT		
C1810-3	20 / pack	6 x 3/8" Pan Hd, Phillips		
C1810-5	20	6 x 3/4" Pan Hd, Phillips		
C1810-8	20	8 x 1/2" Pan Hd, Phillips		
C1810-10	10	8 x 1" Pan Hd, Phillips		
C1810-13	5	10 x 3/4" Pan Hd, Phillips		
C1810-15	5	10 x 1-1/2" Pan Hd, Phillips		
C1820-1	20	4 x 1/2" CSK, Phillips		
C1820-5	20	6 x 3/4" CSK, Phillips		
C1820-8	20	8 x 1/2" CSK, Phillips		
C1820-10	10	8 x 1" CSK, Phillips		
C1820-13	5	10 x 3/4" CSK, Phillips		
C1820-15	5	10 x 1-1/2" CSK, Phillips		
C1830-3	10	3/16 x 7/16" Flat Washers		
C1830-4	10	1/4 x 9/16" Flat Washers		
C1830-5	5	5/16 x 5/8" Flat Washers		
C1830-6	5	3/8 x 13/16" Flat Washers		
C1840-2	10	3/16" (5mm) Spring Washers		
C1840-3	10	1/4" Spring Washers		
C1840-4	5	5/16" (8mm) Spring Wash		
C1840-5	5	3/8" (10mm) Spring Wash		
C1850-2	10	1.6 x 32mm Split Pins		
C1850-5	10	2.5 x 50mm Split Pins		
C1850-8	10	3.2 x 50mm Split Pins		
C1850-9	10	4.0 x 50mm Split Pins		
C1860-13	10	3/16" Hex Nuts A2		
C1860-14	6	1/4" Hex Nuts A2		
C1860-10	2	1/4 x 2" Rnd Hd Screws		

CA1800		STAINLESS STEEL ASSORTMENT <i>Continued</i>	
C1860-5	4 / pack	3/16 x 3/4" Rnd Hd Screws	
C1860-6	4	3/16 x 1" Rnd Hd Screws	
C1860-7	2	3/16 x 1-1/2" Rnd Hd Screws	
C1860-8	4	1/4 x 1" Rnd Hd Screws	
C1870-4	4	6 x 16mm Set Screws	
C1870-6	4	6 x 25mm Set Screws	
C1870-7	2	6 x 40mm Set Screws	
C1870-9	4	8 x 25mm Set Screws	
C1870-11	2	8 x 40mm Set Screws	
C1870-16	10	M6 x 1.00mm Hex Nuts	
C1870-17	6	M8 x 1.25mm Hex Nuts	

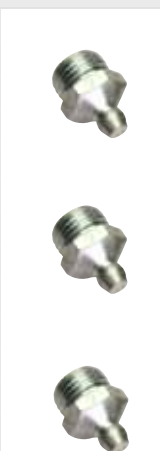
CA1808		STAINLESS STEEL GREASE NIPPLES	
METRIC & IMPERIAL			
C1808-1	10 / pack	1/4" BSF Straight	
C1808-2	20	1/4" UNF Straight	
C1808-3	10	1/8" NPT Straight	
C1808-4	20	1/8" BSP Straight	
C1808-5	10	1/8" NPT 90°	
C1808-6	10	1/8" BSP 90°	
C1808-7	10	1/4 x 1-1/4" UNF	
C1808-8	10	1/4" UNF 45°	
C1808-9	10	M8 x 1.25mm Straight	
C1808-10	20	M6 x 1.00mm Straight	
C1808-11	10	M8 x 1.00mm Straight	
C1808-12	10	M6 x 1.00mm 45°	
C1808-13	10	M6 x 1.00mm 90°	
C1808-14	10	10 x 1.00 Straight	

Bulk Packs: page 126

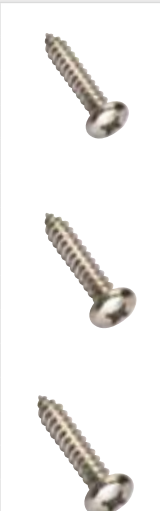
CA1810		STAINLESS STEEL SELF-TAPPING SCREWS	
PAN HEAD, PHILLIPS, 304/A2			
C1810-1	25 / pack	4G x 1/2"	
C1810-2	25	4G x 5/8"	
C1810-3	30	6G x 3/8"	
C1810-4	30	6G x 1/2"	
C1810-5	25	6G x 3/4"	
C1810-6	30	6G x 1"	
C1810-7	30	8G x 3/8"	
C1810-8	30	8G x 1/2"	
C1810-9	30	8G x 3/4"	
C1810-10	30	8G x 1"	
C1810-11	20	8G x 1-1/2"	
C1810-12	30	10G x 1/2"	
C1810-13	30	10G x 3/4"	
C1810-14	30	10G x 1"	
C1810-15	20	10G x 1-1/2"	

CA1815		STAINLESS STEEL ROLL PINS	
METRIC, 304/A2			
C1815-1	20 / pack	2 x 12mm	
C1815-2	20	2.5 x 12mm	
C1815-3	20	2.5 x 26mm	
C1815-4	20	3 x 20mm	
C1815-5	20	3 x 26mm	
C1815-6	15	3.5 x 16mm	

CA1815		STAINLESS STEEL ROLL PINS <i>Continued</i>	
METRIC, 304/A2			
C1815-7	15 / pack	3.5 x 20mm	
C1815-8	15	4 x 20mm	
C1815-9	15	4.5 x 26mm	
C1815-10	10	5 x 20mm	
C1815-11	10	5 x 26mm	
C1815-12	10	6 x 20mm	
C1815-13	10	6 x 26mm	
C1815-14	10	6 x 30mm	

CA1816		STAINLESS STEEL (GRUB) SCREWS	
BSW, METRIC, 316/A4			
C1816-1	10 / pack	3/16 x 3/16" BSW	
C1816-2	10	3/16 x 3/8" BSW	
C1816-3	10	1/4 x 1/4" BSW	
C1816-4	10	1/4 x 1/2" BSW	
C1816-5	10	5/16 x 5/16" BSW	
C1816-6	10	5/16 x 5/8" BSW	
C1816-7	10	3/8 x 5/8" BSW	
C1816-8	10	3/8 x 1" BSW	
C1816-9	10	M5 x 5mm	
C1816-10	10	M5 x 10mm	
C1816-11	10	M6 x 6mm	
C1816-12	10	M6 x 12mm	
C1816-13	10	M8 x 8mm	
C1816-14	10	M8 x 16mm	

CA1817		STAINLESS STEEL CAP SCREWS	
METRIC, 316/A4			
C1817-1	10 / pack	M5 x 10mm	
C1817-2	6	M5 x 25mm	
C1817-3	6	M5 x 35mm	
C1817-4	10	M6 x 10mm	
C1817-5	6	M6 x 16mm	
C1817-6	6	M6 x 20mm	
C1817-7	6	M6 x 25mm	
C1817-8	6	M6 x 40mm	
C1817-9	6	M8 x 16mm	
C1817-10	6	M8 x 20mm	
C1817-11	6	M8 x 25mm	
C1817-12	6	M8 x 35mm	
C1817-13	6	M8 x 40mm	
C1817-14	4	M10 x 25mm	

CA1818		STAINLESS STEEL CAP SCREWS	
BSW, 316/A4			
C1818-1	10 / pack	3/16 x 1/2"	
C1818-2	6	3/16 x 3/4"	
C1818-3	6	3/16 x 1"	
C1818-4	10	1/4 x 1/2"	
C1818-5	6	1/4 x 3/4"	
C1818-6	6	1/4 x 1"	
C1818-7	6	1/4 x 1-1/4"	
C1818-8	6	1/4 x 1-1/2"	
C1818-9	6	5/16 x 1/2"	
C1818-10	6	5/16 x 3/4"	
C1818-11	6	5/16 x 1"	
C1818-12	6	5/16 x 1-1/4"	
C1818-13	6	5/16 x 1-1/2"	
C1818-14	5	3/8 x 1"	

REPLACEMENT PACKS

REPLACEMENT PACKS

REPLACEMENT
PACKS

CA1820 STAINLESS STEEL SELF-TAPPING SCREWS

IMPERIAL, COUNTERSUNK, PHILLIPS, 304/A2		
C1820-1	25 / pack	4G x 1/2"
C1820-2	25	4G x 5/8"
C1820-3	30	6G x 3/8"
C1820-4	30	6G x 1/2"
C1820-5	25	6G x 3/4"
C1820-6	30	6G x 1"
C1820-7	30	8G x 3/8"
C1820-8	30	8G x 1/2"
C1820-9	30	8G x 3/4"
C1820-10	30	8G x 1"
C1820-11	20	8G x 1-1/2"
C1820-12	30	10G x 1/2"
C1820-13	30	10G x 3/4"
C1820-14	30	10G x 1"
C1820-15	20	10G x 1-1/2"

CA1824 STAINLESS STEEL 'E' CLIPS

METRIC, 304/A2		
C1824-1	50 / pack	1.9mm
C1824-2	50	3.2mm
C1824-3	50	5mm
C1824-4	50	6mm
C1824-5	50	8mm
C1824-6	25	10mm
C1824-7	25	12mm
C1824-8	25	15mm

CA1830 STAINLESS STEEL FLAT & PANEL WASHERS

IMPERIAL & METRIC, 304/A2		
C1830-1	50 / pack	1/8 x 5/16"
C1830-2	50	5/32 x 3/8"
C1830-3	50	3/16 x 7/16"
C1830-4	30	1/4 x 9/16"
C1830-5	30	5/16 x 5/8"
C1830-6	25	3/8 x 13/16"
C1830-7	20	7/16 x 7/8"
C1830-8	20	1/2 x 1"
C1830-9	5	5/8 x 1-1/4"
C1830-10	5	3/4 x 1-1/2"
C1830-11	40	M6 x 13mm
C1830-12	20	M12 x 24mm
C1830-13	10	3/16 x 1"
C1830-14	10	1/4 x 1-1/4"
C1830-15	10	5/16 x 1-1/4"
C1830-16	10	3/8 x 1-1/4"

CA1840 STAINLESS STEEL SPRING WASHERS

IMPERIAL, 304/A2		
C1840-1	50 / pack	5/32" (4mm)
C1840-2	50	3/16" (5mm)
C1840-3	50	1/4"
C1840-4	40	5/16" (8mm)
C1840-5	25	3/8" (10mm)
C1840-6	20	7/16"
C1840-7	15	1/2"
C1840-8	10	9/16" (14mm)
C1840-9	10	5/8" (16mm)
C1840-10	5	3/4"
C1840-11	50	6mm
C1840-12	20	12mm

CA1850 STAINLESS STEEL SPLIT PINS

METRIC, 304/A2		
C1850-1	25 / pack	1.6 x 20mm
C1850-2	25	1.6 x 32mm
C1850-3	25	2.5 x 25mm
C1850-4	25	2.5 x 32mm
C1850-5	25	2.5 x 50mm
C1850-6	25	3.2 x 25mm
C1850-7	25	3.2 x 32mm
C1850-8	20	3.2 x 50mm
C1850-9	20	4.0 x 50mm
C1850-10	10	5.0 x 50mm

CA1860 STAINLESS STEEL MACHINE SCREWS & NUTS

BSW, 304/A2		
C1860-1	15 / pack	1/8 x 3/4"
C1860-2	15	1/8 x 1-1/4"
C1860-3	15	5/32 x 3/4"
C1860-4	15	5/32 x 1-1/4"
C1860-5	15	3/16 x 3/4"
C1860-6	15	3/16 x 1"
C1860-7	15	3/16 x 1-1/2"
C1860-8	10	1/4 x 1"
C1860-9	8	1/4 x 1-1/2"
C1860-10	5	1/4 x 2"
C1860-11	30	1/8" Nuts
C1860-12	30	5/32" Nuts
C1860-13	45	3/16" Nuts
C1860-14	23	1/4" Nuts

CA1861 STAINLESS STEEL INTERNAL CIRCLIPS

METRIC, 304/A2		
C1861-1	10 / pack	10mm
C1861-2	10	12mm
C1861-3	10	14mm
C1861-4	10	16mm
C1861-5	10	18mm
C1861-6	10	20mm
C1861-7	10	22mm
C1861-8	10	25mm

CA1862 STAINLESS STEEL EXTERNAL CIRCLIPS

METRIC, 304/A2

C1862-1	20 / pack	6mm
C1862-2	20	8mm
C1862-3	20	10mm
C1862-4	20	12mm
C1862-5	20	14mm
C1862-6	10	16mm
C1862-7	5	20mm
C1862-8	5	22mm



CA1870 STAINLESS STEEL SET SCREWS & NUTS

METRIC, 304/A2

C1870-1	15 / pack	M4 x 20mm
C1870-2	8	M5 x 25mm
C1870-3	4	M5 x 35mm
C1870-4	8	M6 x 16mm
C1870-5	8	M6 x 20mm
C1870-6	8	M6 x 25mm
C1870-7	8	M6 x 40mm
C1870-8	8	M8 x 20mm
C1870-9	6	M8 x 25mm
C1870-10	4	M8 x 35mm
C1870-11	4	M8 x 40mm
C1870-12	4	M8 x 50mm
C1870-13	4	M10 x 35mm
C1870-14	15	M4 Nuts
C1870-15	12	M5 Nuts
C1870-16	32	M6 Nuts
C1870-17	26	M8 Nuts



CA1875 STAINLESS STEEL SET SCREWS & NUTS

UNC, 316/A4

C1875-1	10 / pack	1/4 x 3/4"
C1875-2	10	1/4 x 1"
C1875-3	10	1/4 x 1-1/2"
C1875-4	10	5/16 x 1"
C1875-5	10	5/16 x 1-1/2"
C1875-6	10	3/8 x 1"
C1875-7	10	3/8 x 1-1/2"
C1875-8	30	1/4" Nuts
C1875-9	20	5/16" Nuts
C1875-10	20	3/8" Nuts



CA1880 STAINLESS STEEL SET SCREWS & NUTS

METRIC, 304/A2

C1880-1	15 / pack	M4 x 20mm
C1880-2	15	M4 x 35mm
C1880-3	8	M5 x 25mm
C1880-4	8	M5 x 35mm
C1880-5	15	M6 x 16mm
C1880-6	15	M6 x 20mm
C1880-7	15	M6 x 25mm
C1880-8	10	M6 x 40mm
C1880-9	10	M8 x 20mm



CA1880 STAINLESS STEEL SET SCREWS & NUTS

304/A2, METRIC Continued

C1880-10	10 / pack	M8 x 25mm
C1880-11	8	M8 x 35mm
C1880-12	8	M8 x 40mm
C1880-13	6	M8 x 50mm
C1880-14	6	M10 x 25mm
C1880-15	4	M10 x 35mm
C1880-16	3	M10 x 50mm
C1880-17	2	M12 x 45mm (with Nuts)
C1880-18	30	M4 Nuts
C1880-19	16	M5 Nuts
C1880-20	55	M6 Nuts
C1880-21	42	M8 Nuts
C1880-22	13	M10 Nuts



CA1882 TORX® STAINLESS STEEL SELF-TAPPING SCREWS

PAN, TPX, 304/A4

C1882-1	20 / pack	6G x 1/2"
C1882-2	15	6G x 3/4"
C1882-3	15	6G x 1"
C1882-4	15	8G x 1/2"
C1882-5	15	8G x 3/4"
C1882-6	15	8G x 1"
C1882-7	15	8G x 1-1/2"
C1882-8	15	10G x 1/2"
C1882-9	15	10G x 3/4"
C1882-10	15	10G x 1"
C1882-11	15	10G x 1-1/2"
C1882-12	15	12G x 3/4"
C1882-13	15	12G x 1"
C1882-14	10	12G x 1-1/2"



CA1884 STAINLESS STEEL SELF-TAPPING SCREWS

RAISED, PHILLIPS, 316/A4

C1884-1	30 / pack	4G x 1/2"
C1884-2	30	4G x 5/8"
C1884-3	30	4G x 3/4"
C1884-4	30	4G x 1"
C1884-5	30	6G x 1/2"
C1884-6	25	6G x 3/4"
C1884-7	30	6G x 1"
C1884-8	30	8G x 1/2"
C1884-9	30	8G x 3/4"
C1884-10	30	8G x 1"
C1884-11	30	8G x 1-1/4"
C1884-12	30	8G x 1-1/2"
C1884-13	20	8G x 1-3/4"
C1884-14	30	8G x 2"
C1884-15	30	10G x 3/4"
C1884-16	30	10G x 1"
C1884-17	15	10G x 1-1/4"
C1884-18	10	10G x 1-1/2"
C1884-19	10	10G x 2"

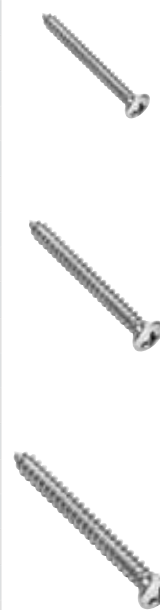

REPLACEMENT
PACKS

Torx® is a registered trademark of Camcar Textron Inc.

REPLACEMENT PACKS

REPLACEMENT
PACKS

CA1885		STAINLESS STEEL HEX SET SCREWS & NUTS	
METRIC, 316/A4			
C1885-1	20 / pack	4 x 20mm	
C1885-2	20	5 x 25mm	
C1885-3	20	5 x 35mm	
C1885-4	20	6 x 16mm	
C1885-5	20	6 x 20mm	
C1885-6	15	6 x 25mm	
C1885-7	10	6 x 40mm	
C1885-8	10	8 x 20mm	
C1885-9	10	8 x 25mm	
C1885-10	10	8 x 30mm	
C1885-11	8	8 x 40mm	
C1885-12	5	8 x 50mm	
C1885-13	5	10 x 25mm	
C1885-14	20	M4 x 0.7mm Plain Nuts	
C1885-15	40	M5 x 0.8mm Plain Nuts	
C1885-16	50	M6 x 1.00mm Plain Nuts	
C1885-17	40	M8 x 1.25mm Plain Nuts	
C1885-18	5	M10 x 1.50mm Plain Nuts	

CA1886		TORX® STAINLESS STEEL MACHINE SCREWS	
METRIC, PAN, TPX, 304/A2			
C1886-1	10 / pack	5 x 10mm	
C1886-2	10	5 x 16mm	
C1886-3	10	5 x 20mm	
C1886-4	10	5 x 25mm	
C1886-5	10	6 x 10mm	
C1886-6	10	6 x 16mm	
C1886-7	10	6 x 20mm	
C1886-8	10	6 x 25mm	
C1886-9	10	6 x 30mm	
C1886-10	10	6 x 50mm	
C1886-11	10	8 x 10mm	
C1886-12	10	8 x 16mm	
C1886-13	10	8 x 20mm	
C1886-14	10	8 x 25mm	

CA1888		STAINLESS STEEL MACHINE SCREWS	
METRIC, PAN, PHILLIPS, 316/A4			
C1888-1	25 / pack	M5 x 10mm	
C1888-2	25	M5 x 16mm	
C1888-3	25	M5 x 20mm	
C1888-4	25	M5 x 25mm	
C1888-5	25	M6 x 10mm	
C1888-6	25	M6 x 16mm	
C1888-7	25	M6 x 20mm	
C1888-8	20	M6 x 25mm	
C1888-9	15	M6 x 30mm	
C1888-10	15	M6 x 35mm	
C1888-11	10	M6 x 40mm	
C1888-12	10	M6 x 45mm	
C1888-13	50	M5 x 0.8 Hex Plain Nuts	
C1888-14	50	M6 x 1.00 Hex Plain Nuts	

CA1890		STAINLESS STEEL MACHINE SCREWS	
METRIC, COUNTERSUNK, PHILLIPS, 316/A4			
C1890-1	25 / pack	M5 x 16mm	
C1890-2	25	M5 x 25mm	
C1890-3	25	M5 x 40mm	
C1890-4	20	M5 x 50mm	
C1890-5	25	M6 x 16mm	
C1890-6	25	M6 x 25mm	
C1890-7	20	M6 x 30mm	
C1890-8	20	M6 x 40mm	
C1890-9	10	M6 x 50mm	
C1890-10	50	M5 x 0.8 Hex Plain Nuts	
C1890-11	50	M6 x 1.00 Hex Plain Nuts	

CA1892		STAINLESS STEEL WING SCREWS & NUTS	
METRIC, 316/A4			
C1892-1	25 / pack	4 x 10mm	
C1892-2	20	4 x 20mm	
C1892-3	20	5 x 10mm	
C1892-4	20	5 x 20mm	
C1892-5	20	5 x 25mm	
C1892-6	20	6 x 10mm	
C1892-7	20	6 x 16mm	
C1892-8	20	6 x 25mm	
C1892-9	25	M4 x 0.7mm Nuts	
C1892-10	20	M5 x 0.8mm Nuts	
C1892-11	20	M6 x 1.00mm Nuts	

CA1894		STAINLESS STEEL RIVETS BLIND	
METRIC, 304/A2			
C1894-1	25 / pack	2.4 x 6mm	
C1894-2	25	3.2 x 6mm	
C1894-3	25	3.2 x 12mm	
C1894-4	25	3.2 x 18mm	
C1894-5	25	4 x 6mm	
C1894-6	25	4 x 12mm	
C1894-7	25	4 x 18mm	
C1894-8	25	4.8 x 6mm	
C1894-9	25	4.8 x 12mm	
C1894-10	20	4.8 x 18mm	
C1894-11	15	4.8 x 24mm	
C1894-12	15	5 x 8mm	
C1894-13	15	5 x 12mm	
C1894-14	15	5 x 18mm	
C1894-15	15	5 x 24mm	
C1894-16	10	5 x 30mm	

Torx® is a registered trademark of Camcar Textron Inc.

CA2005		FUSES	
GLASS, BLADE & EUROPEAN			
C2005-1	10 / pack	1AG	2 Amp.
C2005-2	10	1AG	5 Amp.
C2005-3	10	2AG	7.5 Amp.
C2005-4	10	3AG	2 Amp.
C2005-5	10	3AG	5 Amp.
C2005-6	10	3AG	7.5 Amp.
C2005-7	20	3AG	10 Amp.
C2005-8	20	3AG	15 Amp.
C2005-9	20	3AG	20 Amp.
C2005-10	10	3AG	25 Amp.
C2005-11	10	3AG	30 Amp.
C2005-12	10	3AG	35 Amp.
C2005-14	10	SFE	14 Amp.
C2005-15	10	6AC	8 Amp.
C2005-16	10	6AC	16 Amp.
C2005-17	10	6AC	25 Amp.
C2005-18	10	AF	5 Amp.
C2005-19	10	AF	7.5 Amp.
C2005-20	10	AF	10 Amp.
C2005-21	20	AF	15 Amp.
C2005-22	20	AF	20 Amp.
C2005-23	20	AF	25 Amp.
C2005-24	10	AF	30 Amp.

Bulk Packs: page 125

CA2010		CIRCLIPS	
METRIC, INTERNAL			
C2010-1	20 / pack	8mm	
C2010-2	20	10mm	
C2010-3	20	12mm	
C2010-4	20	14mm	
C2010-5	20	15mm	
C2010-6	20	16mm	
C2010-7	20	18mm	
C2010-8	20	20mm	
C2010-9	10	22mm	
C2010-10	10	24mm	
C2010-11	10	25mm	
C2010-12	10	26mm	
C2010-13	10	28mm	
C2010-14	10	30mm	
C2010-15	10	32mm	
C2010-16	10	35mm	
C2010-17	5	40mm	
C2010-18	5	42mm	
C2010-19	5	45mm	
C2010-20	5	50mm	

Bulk Packs: page 124

CA2015		CIRCLIPS	
METRIC, EXTERNAL			
C2015-1	20 / pack	6mm	
C2015-2	20	8mm	
C2015-3	20	10mm	
C2015-4	20	12mm	
C2015-5	20	14mm	
C2015-6	20	15mm	
C2015-7	20	16mm	
C2015-8	20	18mm	
C2015-9	10	20mm	
C2015-10	10	22mm	
C2015-11	10	24mm	
C2015-12	10	25mm	
C2015-13	10	26mm	
C2015-14	10	28mm	
C2015-15	10	30mm	
C2015-16	10	32mm	
C2015-17	5	35mm	
C2015-18	5	40mm	
C2015-19	5	45mm	
C2015-20	5	50mm	

Bulk Packs: page 124

CA2020		ROLL PINS	
METRIC			
C2020-1	20 / pack	2 x 20mm	
C2020-2	20	2.5 x 16mm	
C2020-3	20	2.5 x 25mm	
C2020-4	20	3 x 16mm	
C2020-5	20	3 x 20mm	
C2020-6	20	3 x 25mm	
C2020-7	20	4 x 16mm	
C2020-8	20	4 x 20mm	
C2020-9	20	4 x 25mm	
C2020-10	20	5 x 20mm	
C2020-11	20	5 x 25mm	
C2020-12	10	5 x 30mm	
C2020-13	10	5 x 40mm	
C2020-14	20	6 x 20mm	
C2020-15	20	6 x 25mm	
C2020-16	20	6 x 30mm	
C2020-17	10	6 x 40mm	
C2020-18	10	6 x 50mm	
C2020-19	5	6 x 60mm	
C2020-20	10	8 x 30mm	
C2020-21	10	8 x 40mm	
C2020-22	5	8 x 50mm	
C2020-23	5	10 x 50mm	
C2020-24	5	10 x 60mm	

Bulk Packs: page 129

REPLACEMENT
PACKS

REPLACEMENT PACKS

REPLACEMENT PACKS

CA2025		ROLL PINS	
IMPERIAL			
C2025-1	20 / pack	3/32 x 1/2"	
C2025-2	20	3/32 x 5/8"	
C2025-3	20	3/32 x 1"	
C2025-4	20	1/8 x 5/8"	
C2025-5	20	1/8 x 3/4"	
C2025-6	20	1/8 x 7/8"	
C2025-7	20	1/8 x 1"	
C2025-8	20	5/32 x 1/2"	
C2025-9	20	5/32 x 1"	
C2025-10	20	3/16 x 3/4"	
C2025-11	20	3/16 x 1"	
C2025-12	20	3/16 x 1-1/4"	
C2025-13	20	3/16 x 1-1/2"	
C2025-14	10	3/16 x 2"	
C2025-15	10	3/16 x 2-1/2"	
C2025-16	20	1/4 x 1"	
C2025-17	10	1/4 x 1-1/2"	
C2025-18	10	1/4 x 2"	
C2025-19	10	1/4 x 2-1/2"	
C2025-20	8	5/16 x 1-1/2"	
C2025-21	8	5/16 x 2"	
C2025-22	8	5/16 x 2-1/2"	
C2025-23	5	3/8 x 2"	
C2025-24	5	3/8 x 2-1/2"	

Bulk Packs: page 129

CA2030		CIRCLIPS	
IMPERIAL, INTERNAL			
C2030-1	20 / pack	1/4"	
C2030-2	20	5/16"	
C2030-3	20	3/8"	
C2030-4	20	1/2"	
C2030-5	20	5/8"	
C2030-6	20	3/4"	
C2030-7	10	7/8"	
C2030-8	10	1"	
C2030-9	10	1-1/16"	
C2030-10	10	1-1/8"	
C2030-11	10	1-3/16"	
C2030-12	10	1-1/4"	
C2030-13	10	1-5/16"	
C2030-14	10	1-3/8"	
C2030-15	10	1-7/16"	
C2030-16	10	1-1/2"	
C2030-17	5	1-5/8"	
C2030-18	5	1-3/4"	
C2030-19	5	1-7/8"	
C2030-20	5	2"	

Bulk Packs: page 124

CA2035		CIRCLIPS	
IMPERIAL, EXTERNAL			
C2035-1	20 / pack	1/4"	
C2035-2	20	5/16"	
C2035-3	20	3/8"	
C2035-4	20	1/2"	
C2035-5	20	5/8"	
C2035-6	20	3/4"	
C2035-7	10	7/8"	
C2035-8	10	1"	
C2035-9	10	1-1/16"	
C2035-10	10	1-1/8"	
C2035-11	10	1-3/16"	
C2035-12	10	1-1/4"	
C2035-13	10	1-5/16"	
C2035-14	10	1-3/8"	
C2035-15	10	1-7/16"	
C2035-16	10	1-1/2"	
C2035-17	5	1-5/8"	
C2035-18	5	1-3/4"	
C2035-19	5	1-7/8"	
C2035-20	5	2"	

Bulk Packs: page 124

CA2040		WIRING TERMINALS	
CRIMP TYPE			
C2040-1	25 / pack	309WF Red Female Full Ins.	
C2040-2	20	309F Red Female Push-on	
C2040-3	25	309M Red Male Push-on	
C2040-4	25	200M Red Male Bullet	
C2040-5	25	200F Red Female Bullet	
C2040-6	25	320WF Blue Female Full Ins.	
C2040-7	20	320F Blue Female Push-on	
C2040-8	25	320M Blue Male Push-on	
C2040-9	25	201F Blue Female Bullet	
C2040-10	25	201M Blue Male Bullet	
C2040-11	53	55WF Yellow Female Full Ins.	
C2040-12	53	55F Yellow Female Push-on	
C2040-13	10	355M Yellow Male Push-on	
C2040-14	10	13-5 3/16" Red Ring	
C2040-15	10	13-6 1/4" Red Ring	
C2040-16	10	22-5 3/16" Blue Ring	
C2040-17	10	23-8 5/16" Blue Ring	
C2040-18	55	3-8 5/16" Yellow Ring	
C2040-19	55	3-10 3/8" Yellow Ring	
C2040-20	10	22Y-4 5/32" Blue Spade	
C2040-21	5	KSR100 Red Wire Tap	
C2040-22	5	KSB100 Blue Wire Tap	
C2040-23	10	153V Male Push-on 2-way	
C2040-24	10	TG1 Red Joiner	
C2040-25	10	TG2 Blue Joiner	
C2040-26	10	TG3 Yellow Joiner	
C2040-27	20	QCF Fem Lanced Push-on	
C2040-28	20	QCM Male Lanced Push-on	

Bulk Packs: page 135

CA2045 SELF-TAPPING SCREWS

BLACK ZINC, PAN & MUSHROOM HEAD, PHILLIPS		
C1720-1	40 / pack	6G x 3/8"
C1720-2	30	6G x 1/2"
C1720-3	30	6G x 3/4"
C1720-4	30	8G x 3/8"
C1720-5	40	8G x 1/2"
C1720-6	30	8G x 3/4"
C1720-7	30	8G x 1"
C1720-8	25	8G x 1-1/2"
C1720-9	40	10G x 1/2"
C1720-10	30	10G x 3/4"
C1720-11	25	10G x 1"
C1720-12	20	10G x 1-1/2"
C1720-13	15	10G x 2"
C1720-14	30	12G x 1"
C1200-1	50	6G x 1/2" Pan Head
C1200-2	50	6G x 3/4" Pan Head
C1200-3	30	6G x 1" Pan Head
C1200-4	30	8G x 3/8" Pan Head
C1200-5	30	8G x 5/8" Pan Head
C1200-6	30	8G x 3/4" Pan Head
C1200-7	30	8G x 1" Pan Head
C1200-8	20	8G x 1-1/2" Pan Head
C1200-9	30	10G x 1/2" Pan Head
C1200-10	20	10G x 3/4" Pan Head
C1200-11	20	10G x 1" Pan Head
C1200-12	15	12G x 1" Pan Head
C1200-13	30	6G x 1" Raised Head
C1200-14	30	8G x 3/4" Raised Head

Bulk Packs: page 129

CA2050 FLAT SPRING STEEL WASHERS

ZINC PLATED, IMPERIAL & METRIC		
C576-1	150 / pack	3/16"
C576-2	150	1/4"
C576-3	75	5/16"
C576-4	40	3/8"
C576-5	25	7/16"
C576-6	25	1/2"
C576-7	10	5/8"
C576-8	5	3/4" & 20mm
C576-9	150	6mm
C576-10	30	10mm
C576-11	20	12mm
C576-12	10	9/16"
C648-1	200	3/16" (5mm)
C648-2	150	1/4"
C648-3	75	5/16" (8mm)
C648-4	40	3/8"
C648-5	25	7/16"

CA2050 FLAT SPRING STEEL WASHERS *Continued*

ZINC PLATED, IMPERIAL & METRIC		
C648-7	10 / pack	5/8" (16mm)
C648-8	3	20mm
C648-9	200	5/32" (4mm)
C648-10	150	6mm
C648-11	40	10mm
C648-12	20	12mm
C648-6	20	1/2"

Bulk Packs: p133-134

CA2060 FIBRE WASHERS

1/32", 1/16" & 3/32" THICK		
C400-1	30 / pack	1/8 x 5/16 x 1/32"
C400-2	30	3/16 x 1/2 x 1/32"
C400-3	50	1/4 x 9/16 x 1/32"
C400-4	50	5/16 x 5/8 x 1/32"
C400-5	50	3/8 x 3/4 x 1/32"
C400-6	50	7/16 x 13/16 x 1/32"
C400-7	50	1/2 x 7/8 x 1/32"
C400-8	30	9/16 x 15/16 x 1/32"
C400-9	30	5/8 x 1 x 1/32"
C400-10	15	11/16 x 1-1/16 x 1/32"
C400-11	15	3/4 x 1-1/8 x 1/32"
C400-12	10	13/16 x 1-3/16 x 1/32"
C400-13	10	7/8 x 1-3/8 x 1/32"
C400-14	10	1 x 1-1/2 x 1/32"
C390-1	45	5/32 x 5/16 x 1/16"
C390-2	45	3/16 x 3/8 x 1/16"
C390-3	35	7/32 x 7/16 x 1/16"
C390-4	55	1/4 x 7/16 x 1/16"
C390-5	50	5/16 x 1/2 x 1/16"
C390-6	45	3/8 x 5/8 x 1/16"
C390-7	25	7/16 x 11/16 x 1/16"
C390-8	25	1/2 x 3/4 x 1/16"
C390-9	20	9/16 x 13/16 x 1/16"
C390-10	20	5/8 x 7/8 x 1/16"
C390-11	20	11/16 x 15/16 x 1/16"
C390-12	20	3/4 x 1 x 1/16"
C150-1	40	1/2 x 3/4 x 3/32"
C150-2	10	5/8 x 7/8 x 3/32"
C150-3	30	3/4 x 1-1/8 x 3/32"
C150-4	10	13/16 x 1-1/16 x 3/32"
C150-5	10	7/8 x 1-1/4 x 3/32"
C150-6	10	1 x 1-3/8 x 3/32"
C150-8	3	18 x 27mm x 3/32"
C150-9	10	30 x 38mm x 3/32"
C150-10	10	14 x 20mm x 3/32"
C150-11	10	No.1 O/S Plug x 3/32"

Bulk Packs: page 133













REPLACEMENT
PACKS

REPLACEMENT PACKS

REPLACEMENT
PACKS

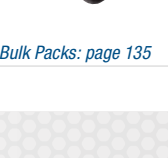
CA2070		BRASS HOSE FITTINGS		
'T' PIECES, JOINERS, TAILS, ELBOWS & ADAPTORS				
<i>Assortment contents listed below</i>				
2401	2 qty	1/4 x 1/8" Reducing Bush		
2403	2	3/8 x 1/4" Reducing Bush		
2404	2	1/2 x 1/8" Reducing Bush		
2405	2	1/2 x 1/4" Reducing Bush		
2406	2	1/2 x 3/8" Reducing Bush		
2601	2	1/8" Hexagon Socket		
2602	2	1/4" Hexagon Socket		
2603	2	3/8" Hexagon Socket		
2604	2	1/2" Hexagon Socket		
3501	2	1/8" Female 'T'		
3502	2	1/4" Female 'T'		
6401	2	1/8" Hex Taper Plug		
6402	2	1/4" Hex Taper Plug		
6403	2	3/8" Hex Taper Plug		
6404	2	1/2" Hex Taper Plug		
P301	2	3/16 x 1/8" Male Barb		
P302	2	1/4 x 1/8" Male Barb		
P302A	2	1/4 x 1/4" Male Barb		
P303	2	5/16 x 1/8" Male Barb		
P304	2	3/8 x 1/8" Male Barb		
P305	2	3/8 x 1/4" Male Barb		
P306	2	5/16 x 1/4" Male Barb		
P307	2	1/2 x 1/4" Male Barb		
P308	2	5/8 x 1/4" Male Barb		
P309	2	5/16 x 3/8" Male Barb		
P310	2	3/8 x 3/8" Male Barb		
P311	2	1/2 x 3/8" Male Barb		
P312	2	5/8 x 3/8" Male Barb		
P314	2	3/8 x 1/2" Male Barb		
P315	2	1/2 x 1/2" Male Barb		
P316	2	5/8 x 1/2" Male Barb		
P3-1208	2	3/4 x 1/2" Male Barb		
P3-1212	2	3/4 x 3/4" Male Barb		
P601	2	3/16 x 1/8" Male Barb 90°		
P602	2	1/4 x 1/8" Male Barb 90°		
P603	2	5/16 x 1/8" Male Barb 90°		
P604	2	3/8 x 1/8" Male Barb 90°		
P605	2	3/8 x 1/4" Male Barb 90°		
P606	2	5/16 x 1/4" Male Barb 90°		
P607	2	1/2 x 1/4" Male Barb 90°		
P616	2	5/8 x 1/2" Male Barb 90°		
P701	2	3/16" Hose Joiner		
P702	2	1/4" Hose Joiner		
P703	2	5/16" Hose Joiner		
P704	2	3/8" Hose Joiner		
P705	2	1/2" Hose Joiner		
P706	2	5/8" Hose Joiner		
P1402	2	3/16" 3 Way 'T' Barb		
P1403	2	1/4" 3 Way 'T' Barb		
P1404	2	5/16" 3 Way 'T' Barb		
P1405	2	3/8" 3 Way 'T' Barb		
P1406	2	1/2" 3 Way 'T' Barb		
P1407	2	5/8" 3 Way 'T' Barb		



Bulk Packs: p153-155

CA2075		VACUUM HOSE & TUBE CONNECTORS	
<i>Assortment contents listed below</i>			
CVC1	2 qty	3mm 'T' Piece	
CVC2	2	5mm 'T' Piece	
CVC3	2	6mm 'T' Piece	
CVC4	2	8mm 'T' Piece	
CVC5	2	10mm 'T' Piece	
CVC6	2	3mm 90° Elbow	
CVC7	2	5mm 90° Elbow	
CVC8	2	6mm 90° Elbow	
CVC9	2	8mm 90° Elbow	
CVC10	2	10mm 90° Elbow	
CVC11	2	Reducing 'T' Piece 3-4-3	
CVC12	2	Reducing 'T' Piece 4-6-4	
CVC13	2	Reducing 'T' Piece 6-4-6	
CVC14	2	Reducing 'T' Piece 8-4-8	
CVC15	2	Reducing 'T' Piece 8-6-8	
CVC16	2	Reducing 'T' Pce 10-6-10	
CVC17	2	3mm Straight Connector	
CVC18	2	5mm Straight Connector	
CVC19	2	6mm Straight Connector	
CVC20	2	8mm Straight Connector	
CVC21	2	10mm Straight Connector	
CVC22	2	Reducing Str Conn 4-3	
CVC23	2	Reducing Str Conn 6-4	
CVC24	2	Reducing Str Conn 8-6	
CVC25	2	Reducing Str Conn 10-6	
CVC26	2	Reducing Str Conn 10-8	
CVC27	2	4 Way 'X' Piece 5mm	
CVC28	2	4 Way 'X' Piece 6mm	
CVC29	2	3 Way 'Y' Piece 3mm	
CVC30	2	3 Way 'Y' Piece 5mm	
CVC31	2	3 Way 'Y' Piece 6mm	
CVC32	2	3 Way 'Y' Piece 8mm	
CVC33	2	3 Way 'Y' Piece 10mm	
CVC35	2	4mm x 1/4" BSP Tailpiece	
CVC36	2	5mm x 1/4" BSP Tailpiece	
CVC37	2	6mm x 1/4" BSP Tailpiece	
CVC38	2	8mm x 1/4" BSP Tailpiece	
CVC39	2	6mm x 1/4" BSP 90° Elbow	
CVC40	2	8mm x 1/4" BSP 90° Elbow	
CVC41	2	1/4" BSP Hex Taper Plug	
CVC42	2	1/8" BSP Hex Taper Plug	
CVC43	2	3/8" BSP Hex Taper Plug	
CVC44	10	3mm Caps	
CVC45	10	4mm Caps	
CVC46	10	5mm Caps	
CVC47	10	6mm Caps	
CVC48	5	8mm Caps	
CVC49	5	10mm Caps	

Bulk Packs: page 135

CA2080 TRIM CLIPS

SCRIVETS - BLACK

		TYPE	SUITS HOLE		
CBP08	50 / pack	15mm Screw	8.2-10mm		
CBP36	50	22.2mm Screw	2-6mm		
CBP55	50	18mm Sc. Ford	8.4-10.2mm		
CBP160	40	20mm Screw	8mm		
CBP161	50	20mm Screw	8mm		
CBP162	50	18mm Screw	8mm		
CBP163	25	18mm Push	9mm		
CBP164	25	20mm Push	10mm		
CBP165	40	20mm Push	8mm		
CBP166	50	17mm Screw	7mm		
CBP167	50	15mm Screw	8mm		
CBP168	30	20mm Screw	8mm		
CBP169	40	20mm Push	8mm		
CBP170	50	18mm Push	7mm		
CBP171	25	14mm Push	6mm		
CBP172	50	15mm Push	6mm		

Bulk Packs: p19-123

CA2085 TRIM CLIPS

XMAS TREE CLIPS

		HEAD SIZE	SUITS HOLE	
CBP03	50 / pack	16mm Grey	6.6-7.5mm	
CBP04	50	16mm Black	6.6-7.5mm	
CBP57	50	15mm Black	4.9 - 5.1mm	
CBP58	50	14mm Black	2.5-10.8mm	
CBP60	50	17mm Black	2-10mm	
CBP61	50	20mm Black	2.5-11mm	
CBP62	50	20.8mm Black	2-10mm	
CBP63	40	20.5mm Black	2.5-19.5mm	
CBP105	50	12mm Black	2-9mm	
CBP158	20	25mm Black	6.5-8mm	
CBP173	50	7mm Black	7.5mm	
CBP174	50	18mm Black	5-7mm	
CBP175	25	25mm Black	8mm	
CBP176	25	9.5mm Black	9.5mm	
CBP177	30	18mm Black	8mm	
CBP178	50	18mm Black	7.8-8mm	

Bulk Packs: p119-123

CA2096 MANIFOLD STUDS & NUTS

CHVLS1	10 / pack	10 x 54 x 1.25mm		
CUNIV1	10	10 x 1.25-1.50 x 50mm		
CDNS2	10	M8 x 50 x 1.25mm		
CDNS1	10	M8 x 1.25 x 38mm		
CGMS1	10	3/8 x 2"		
CGMS3	10	M10 x 1.25 x 41mm		
CFDS2	20	M10 x 1.5 x 40mm		
CFDS1	10	7/16 x 2-1/4"		
CHB11	10	3/8 x 1" UNC Header Bolts		
CGMN1	10	3/8" UNC Brass Nuts		
CFDN1	10	7/16" UNC Brass Nuts		
CDNN1	10	M8 X 1.25mm Brass Nuts		
CTYN1	10	10 x 1.25mm Brass Nuts		
CMNS2	10	M10 x 1.5 Brass Nuts		
CDNN2	10	M8 x 1.25mm Steel Nuts		
CFDN2	10	7/16" UNC Steel Nuts		
CGMN3	10	3/8" UNC Steel Nuts		
CMNS1	10	M10 x 1.5mm Steel Nuts		
CTYN2	10	M10 x 1.25mm Steel Nuts		

Bulk Packs: page 127

CA2140 DRAIN (SUMP) PLUG WASHERS

Assortment contents listed below

CAW1218	50 qty	12 x 18 x 1.5mm	
CAW1420	50	14 x 20 x 1.5mm	
CAW1622	50	16 x 22 x 1.5mm	
CAW1824	50	18 x 24 x 1.5mm	
CAW2024	50	20 x 24 x 1.5mm	
CAW2227	50	22 x 27 x 1.5mm	
CAW2229	50	22 x 29 x 1.5mm	
CAW2430	50	24 x 30 x 1.8mm	
CFW14	25	14 x 20 x 2.5 No.14 Plug	
CFW18	25	18 x 27 x 2.5 No.18 Plug	
CFW31	25	12 x 24 x 2.00mm	
CFW32	25	18 x 28 x 2.00mm	
CFW1224	25	12 x 24 x 2.00mm	
CFW1622	25	16 x 22 x 2.00mm	
CFW1828	25	18 x 28 x 2.00mm	
CFW2535	25	25 x 35 x 2.00mm	
CFW3321	50	1/2 x 3/4 x 3/32" No.1 Plug	
CFW3329	25	1/2 + .028" No.1 OS Plug	
CFW3328	50	5/8 x 7/8 x 3/32" No.3 Plug	
CWC49	100	14 x 20 x 1.5mm	
CWC51	50	16 x 22 x 1.5mm	
CWC52	50	18 x 24 x 1.5mm	
CWC53	50	20 x 26 x 1.5mm	
CWC1218	20	12 x 18mm	
CWC1622	20	16 x 22mm	

Bulk Packs: page 133

CA2173 BONDED SEAL WASHERS

METRIC & IMPERIAL

C2173-1	15 / pk	1/8" BSP	
C2173-2	15	1/4" BSP	
C2173-3	15	3/8" BSP	
C2173-4	15	1/2" BSP	
C2173-5	8	5/8" BSP	
C2173-6	6	3/4" BSP	
C2173-7	4	1" BSP	
C2173-8	4	1-1/4" BSP	
C2173-9	10	8mm	
C2173-10	10	10mm	
C2173-11	10	12mm	
C2173-12	10	14mm	
C2173-13	6	16mm	
C2173-14	6	18mm	
C2173-15	6	20mm	
C2173-16	6	22mm	
C2173-17	5	26mm	
C2173-18	5	27mm	
C2173-19	5	28mm	
C2173-20	5	30mm	
C2173-21	5	33mm	
C2173-22	2	42mm	

Bulk Packs: page 132

REPLACEMENT PACKS

CA2174 RUBBER GROMMETS			
WIRING & BLANKING			
		I.D.	PANEL HOLE O.D.
C63-1	8 / pk	1/8" x 9/32"	7/16"
C63-2	8	3/16" x 5/16"	7/16"
C63-3	8	1/4" x 1/2"	9/16"
C63-4	8	5/16" x 17/32"	3/4"
C63-5	8	3/8" x 1/2"	11/16"
C63-6	8	3/8" x 9/16"	11/16"
C63-7	8	3/8" x 3/4"	1"
C63-8	8	7/16" x 3/4"	1"
C63-9	8	1/2" x 21/32"	13/16"
C63-10	8	5/8" x 1"	1-1/8"
C63-11	8	3/4" x 15/16"	1-5/16"
C63-12	8	29/32" x 1-1/4"	1-1/2"
C90-1	20	5/16"	
C90-2	15	3/8"	
C90-3	15	1/2"	
C90-4	10	5/8"	
C90-5	10	3/4"	
C90-6	5	7/8"	
C90-7	8	1"	
C90-8	8	1-1/8"	

Bulk Packs: page 126

CA2177 WOODRUFF KEYS			
IMPERIAL & METRIC			
C177-1	12	1/2 x 3/32"	WK2
C177-2	24	1/2 x 1/8"	WK3
C177-3	24	5/8 x 1/8"	WK5
C177-4	12	5/8 x 5/32"	WK6
C177-5	12	3/4 x 1/8"	WK7
C177-6	12	3/4 x 3/16"	WK9
C177-7	12	3/4 x 5/32"	WK8
C177-8	12	7/8 x 3/16"	WK11
C177-9	12	1 x 3/16"	WK13
C177-10	12	1 x 1/4"	WK15
C177-11	6	1-1/8 x 3/16"	WK16
C177-12	6	1-1/8 x 1/4"	WK18
C177-13	3	1-1/4 x 1/4"	WK21
C177-14	6	7/8 x 1/4"	WKA
C177-15	6	1-1/8 x 5/16"	WKC
C177-16	3	1-1/4 x 5/16"	WKD
C177-17	3	1-1/4 x 3/8"	WKE
C1705-1	10	2 x 10mm	MWK3
C1705-2	15	2.5 x 10mm	MWK5
C1705-3	15	3 x 10mm	MWK6
C1705-4	15	3 x 13mm	MWK7
C1705-5	15	3 x 16mm	MWK8
C1705-6	15	3 x 19mm	MWK9
C1705-7	8	4 x 13mm	MWK10
C1705-8	8	4 x 16mm	MWK11
C1705-9	8	4 x 19mm	MWK12
C1705-10	8	5 x 16mm	MWK14
C1705-11	8	5 x 19mm	MWK15
C1705-12	10	5 x 22mm	MWK16
C1705-13	8	6 x 22mm	MWK19
C1705-14	8	6 x 28mm	MWK21
C1705-15	5	8 x 28mm	MWK26
C1705-16	5	8 x 32mm	MWK27
C1705-17	3	10 x 32mm	MWK30

Bulk Packs: page 135

CA2206 6mm FASTENERS		
C100-2	40 / pack	M6 x 1.00 Flange Nuts
C270-2	50	M6 x 1.00 Self-Lock Nuts
C431-5	20	M6 x 16 Set Screws
C431-6	20	M6 x 20 Set Screws
C431-7	20	M6 x 25 Set Screws
C431-8	15	M6 x 40 Set Screws
C431-20	50	M6 x 1.00 Hex Nuts
C495-3	20	M6 x 16 Flange Bolts
C495-4	20	M6 x 20 Flange Bolts
C495-5	20	M6 x 25 Flange Bolts
C495-6	20	M6 x 30 Flange Bolts
C495-7	15	M6 x 40 Flange Bolts
C576-9	150	6 x 12.5 x 1.2mm Flat Wash
C648-10	150	6mm Spring Washers
C1417-4	20 qty	M6 x 10mm Cap Screws
C1417-5	12	M6 x 16mm Cap Screws
C1417-6	12	M6 x 20mm Cap Screws
C1417-7	12	M6 x 25mm Cap Screws
C1730-2	15	1/4 x 1-1/4" Body Washers
C1780-3	50	6mm Ext. Star Washers
C1780-10	50	6mm Int. Star Washers

Bulk Packs: page 142

CA2208 8mm FASTENERS		
C100-3	20 / pack	M8 x 1.25 Flange Nuts
C270-4	25	M8 x 1.25 Self-Lock Nuts
C431-9	12	M8 x 20 Set Screws
C431-10	12	M8 x 25 Set Screws
C431-11	10	M8 x 35 Set Screws
C431-12	10	M8 x 40 Set Screws
C431-13	8	M8 x 50 Set Screws
C431-21	40	M8 x 1.25 Hex Nuts
C495-8	15	M8 x 16 Flange Bolts
C495-9	15	M8 x 20 Flange Bolts
C495-10	12	M8 x 25 Flange Bolts
C495-11	10	M8 x 30 Flange Bolts
C495-12	10	M8 x 40 Flange Bolts
C495-13	7	M8 x 50 Flange Bolts
C576-3	75	8 x 17 x 1.2mm Flat Wash
C648-3	75	8mm Spring Washers
C1417-9	12	M8 x 16mm Cap Screws
C1417-11	12	M8 x 25mm Cap Screws
C1730-3	40	5/16 x 1-1/4" Body Washers
C1780-4	50	8mm Ext. Star Washers
C1780-11	50	8mm Int. Star Washers

Bulk Packs: p142-143

CA2210 10mm FASTENERS		
C100-4	20 / pack	M10 x 1.25 Flange Nuts
C100-5	20	M10 x 1.5 Flange Nuts
C270-6	25	M10 x 1.25 Self-Lock Nuts
C270-7	25	M10 x 1.5 Self-Lock Nuts
C431-14	8	M10 x 25 Set Screws
C431-15	6	M10 x 35 Set Screws
C431-16	4	M10 x 50 Set Screws
C431-22	20	M10 x 1.5 Hex Nuts
C480-13	8	M10 x 25 x 1.25 Set Screw
C480-14	6	M10 x 35 x 1.25 Set Screw
C480-15	4	M10 x 50 x 1.25 Set Screw
C480-22	20	M10 x 1.25 Hex Nuts

CA2210 10mm FASTENERS <i>Continued</i>		
C495-14	8 / pack	M10 x 25 x 1.25 Flange Bolt
C495-15	6	M10 x 35 x 1.25 Flange Bolt
C495-16	6	M10 x 40 x 1.25 Flange Bolt
C495-17	5	M10 x 50 x 1.25 Flange Bolt
C576-10	30	10 x 21 x 1.6 Flat Steel Wash
C648-11	40	10mm Spring Washers
C1730-4	40	3/8 x 1-1/4" Body Washers
C1780-5	50	10mm Ext. Star Washers
C1780-12	50	10mm Int. Star Washers

Bulk Packs: page 143

CA2240 FLAT & BODY WASHERS

STEEL, ZINC PLATED		
CWS1	400 / pk	1/8" Flat
CWS2	400	5/32" Flat
CWS3	200	3/16" Flat
CWS4	200	1/4" Flat
CWS5	200	5/16" Flat
CWS6	100	3/8" Flat
CWS7	75	7/16" Flat
CWS8	50	1/2" Flat
CWS9	50	9/16" Flat
CWS10	25	5/8" Flat
CWS11	15	3/4" Flat
CWS12	15	7/8" Flat
CWS13	15	1" Flat
CWS30	200	6mm Flat
CWS32	100	10mm Flat
CWS33	50	12mm Flat
CBW2	25	1/4 x 1-1/4" Body
CBW3	25	5/16 x 1-1/4" Body
CBW4	25	3/8 x 1-1/4" Body
CBW5	20	1/2 x 1-1/2" Body

Bulk Packs: p133-134

CA2260 FUEL INJECTION COPPER WASHERS

METRIC		
C226-1	25 / pk	6 x 10 x 1mm
C226-2	25	8 x 12 x 1mm
C226-3	25	8 x 14 x 1mm
C226-4	25	10 x 14 x 1mm
C226-5	25	10 x 16 x 1mm
C226-6	25	12 x 16 x 1.5mm
C226-7	25	12 x 18 x 1.5mm
C226-8	25	14 x 18 x 1.5mm
C226-9	25	14 x 20 x 1.5mm
C226-10	25	16 x 20 x 1.5mm
C226-11	25	16 x 22 x 1.5mm
C226-12	10	18 x 24 x 1.5mm
C226-13	10	20 x 26 x 1.5mm
C226-14	10	26 x 31 x 2mm
C1660-1	40	5 x 10mm
C1660-2	40	6 x 12.5mm
C1660-3	40	8 x 16mm
C1660-4	40	10 x 20mm
C1660-5	35	12 x 22mm
C1660-6	20	14 x 24mm
C1660-7	20	16 x 25mm
C1660-8	15	20 x 30mm
C1660-9	5	22 x 35mm
C1660-10	5	24 x 38mm

Bulk Packs: page 133

CA2265 PLASTIC TRIM CLIPS & SCREW GROMMETS		
C2265-1	15 / pk	Trim Anchor
C2265-2	10	Scrivet Clips 6mm
C2265-3	10	Scrivet Clips 8mm
C2265-4	5	Captive Nuts - M6 Short
C2265-5	5	Captive Nuts - M6 Long
C2265-6	5	Captive Nuts - M8 Short
C2265-7	5	Captive Nuts - M8 Long
C2265-8	10	Window Winder Clips
C2265-9	15	Xmas Tree Beige 16mm Hd Dia.
C2265-10	15	Xmas Tree Grey 16mm Hd Dia.
C2265-11	10	Xmas Tree Blue 20mm Hd Dia.
C2265-12	10	Xmas Tree White 20mm Hd Dia.
C2265-13	5	Xmas Tree Grey 34mm Hd Dia.
C2265-14	5	Xmas Tree Black 34mm Hd Dia.
C1735-1	5	Xmas Tree Black 16mm Hd Dia.
C1735-4	5	Canoe Clip Black 14mm Hd Dia.
C1735-5	5	Canoe Clip Brown 14mm Hd Dia.
C1735-7	5	Door Panel Clip
C1735-8	5	Door Panel Clip Universal
C1735-9	5	Door Trim Brush
C1735-11	5	Screw Gromm Sq 3/8 x 3/8" (10G)
C1735-12	5	Screw Gromm Sq 6.9 x 7.3mm (6G)
C1735-13	5	Screw Gromm Sq 3/8 x 3/8" (6G)
C1735-14	5	Screw Gromm Sq 8.3 x 8.3mm (8G)

Bulk Packs: p119-123

CA2276 SHIM STEEL WASHERS		
C276-1	18 / pk	5/8 x 1-1/8"
C276-2	24	3/4 x 1-7/16"
C276-3	18	7/8 x 1-5/8"
C276-4	24	27/32 x 1-5/16"
C276-6	6	1 x 2"
C276-10	12	25/32 x 1-5/16"
C276-12	12	1-1/8 x 1-5/8"
C276-13	6	1-3/8 x 1-3/4"
C276-15	12	3/4 x 1-1/16"
C276-16	12	15/16 x 1-5/8"
C276-17	12	7/8 x 1-7/16"
C276-18	12	13/16 x 1-7/16"
C276-19	18	7/8 x 1-9/16"
C276-20	6	15/16 x 1-3/4"
C276-21	18	1-1/8 x 1-13/16"
C276-22	6	1-1/32 x 1-5/8"
C276-23	6	25/32 x 1-1/4"
C276-24	6	29/32 x 1-1/2"
C276-25	6	3/4 x 1-5/8"
C276-27	6	1-9/64 x 1-27/32"
C276-36	12	3/4 x 1-3/8"
C276-38	24	11/16 x 1-1/8"
C1750-1	10	3/16 x 1/2"
C1750-2	30	1/4 x 9/16"
C1750-3	30	5/16 x 5/8"
C1750-4	30	3/8 x 3/4"
C1750-5	15	7/16 x 13/16"

REPLACEMENT
PACKS

REPLACEMENT PACKS

REPLACEMENT
PACKS

CA2276 SHIM STEEL WASHERS <i>Continued</i>		
C1750-6	15 / pack	1/2 x 7/8"
C1750-7	10	9/16 x 15/16"
C1750-8	10	5/8 x 1"
C1750-9	10	11/16 x 1-1/16"
C1750-10	10	3/4 x 1-1/8"
C1750-11	5	13/16 x 1-3/16"
C1750-12	5	7/8 x 1-1/4"
C1750-13	5	15/16 x 1-3/8"
C1750-14	5	1 x 1-1/2"



CA2300 SOCKET HEAD CAP SCREWS		
BSW, HIGH TENSILE		
<i>Assortment contents listed below</i>		
C91203010	40 / pack	3/16 x 5/8
C91203020	30	3/16 x 1-1/4
C91203024	30	3/16 x 1-1/2
C91203028	30	3/16 x 1-3/4
C91203032	10	3/16 x 2
C91204010	10	1/4 x 5/8
C91204020	15	1/4 x 1-1/4
C91204024	10	1/4 x 1-1/2
C91205010	20	5/16 x 5/8
C91205012	20	5/16 x 3/4
C91205016	10	5/16 x 1
C91205020	10	5/16 x 1-1/4
C91205024	10	5/16 x 1-1/2
C91205028	5	5/16 x 1-3/4
C91205036	10	5/16 x 2-1/4
C91205040	5	5/16 x 2-1/2
C91206012	10	3/8 x 3/4
C91206024	10	3/8 x 1-1/2
C91206028	3	3/8 x 1-3/4
C91206032	2	3/8 x 2
C91206036	3	3/8 x 2-1/4
C91208012	4	1/2 x 3/4
C91208020	1	1/2 x 1-1/4
C91208028	1	1/2 x 1-3/4
C91208036	1	1/2 x 2-1/4



Bulk Packs: page 130

CA2370 BOLTS & NUTS		
HEX HEAD, UNC, GR8		
C2370-1	25 / pack	1/4 x 3/4" Set Screws
C2370-2	25	1/4 x 1" Set Screws
C2370-3	20	1/4 x 1-1/2" Bolts
C2370-4	15	1/4 x 2" Bolts
C2370-5	20	5/16 x 3/4" Set Screws
C2370-6	20	5/16 x 1" Set Screws
C2370-7	15	5/16 x 1-1/2" Bolts
C2370-8	10	5/16 x 2" Bolts
C2370-9	15	3/8 x 1" Set Screws
C2370-10	10	3/8 x 1-1/2" Bolts
C2370-11	10	3/8 x 2" Bolts



CA2370 BOLTS & NUTS <i>Continued</i>		
HEX HEAD, UNC, GR8		
C2370-12	10 / pack	7/16 x 1" Set Screws
C2370-13	10	7/16 x 1-1/2" Bolts
C2370-14	5	7/16 x 2" Bolts
C2370-15	8	1/2 x 1" Set Screws
C2370-16	5	1/2 x 1-1/2" Bolts
C2370-17	5	1/2 x 2" Bolts
C2370-18	50	1/4" Plain Nuts
C2370-19	50	5/16" Plain Nuts
C2370-20	25	3/8" Plain Nuts
C2370-21	25	7/16" Plain Nuts
C2370-22	15	1/2" Plain Nuts



CA2385 AUTO FUSES		
BLADE, MICRO, MINI BLADE & CIRCUIT BREAKER		
C110-1	10 / pack	AF Blade 3 Amp.
C110-2	10	AF Blade 5 Amp.
C110-3	10	AF Blade 7.5 Amp.
C110-4	10	AF Blade 10 Amp.
C110-5	25	AF Blade 15 Amp.
C110-6	25	AF Blade 20 Amp.
C110-7	10	AF Blade 25 Amp.
C110-8	10	AF Blade 30 Amp.
C111-1	15	Micro 3 Amp.
C111-2	15	Micro 5 Amp.
C111-3	15	Micro 7.5 Amp.
C111-4	15	Micro 10 Amp.
C111-5	15	Micro 15 Amp.
C111-6	15	Micro 20 Amp.
C111-7	15	Micro 25 Amp.
C111-8	15	Micro 30 Amp.
C112-1	15	Mini 3 Amp.
C112-2	15	Mini 5 Amp.
C112-3	15	Mini 7.5 Amp.
C112-4	15	Mini 10 Amp.
C112-5	15	Mini 15 Amp.
C112-6	15	Mini 20 Amp.
C112-7	15	Mini 25 Amp.
C112-8	15	Mini 30 Amp.
C113-1	5	Circuit Breaker 5 Amp.
C113-2	5	Circuit Breaker 7.5 Amp.
C113-3	5	Circuit Breaker 10 Amp.
C113-4	5	Circuit Breaker 15 Amp.
C113-5	5	Circuit Breaker 20 Amp.
C113-6	5	Circuit Breaker 25 Amp.
C113-7	5	Circuit Breaker 30 Amp.
C2385-1	15	Mini 4 Amp.
C2385-2	15	Micro 4 Amp.



CA2415 GREASE NIPPLES	
METRIC & IMPERIAL	
<i>Assortment contents listed below</i>	
CGN3	50 / pack 6 x 10 x 1mm
CGN161	50 M6 x 1.00 Straight
CN1	25 1/4" BSF Straight
CN12	10 5/16" BSF Straight
CN15	10 M8 x 1.25 Straight
CN19	25 M8 x 1.25 45°
CN28	25 1/8" NPT Straight
CN29	25 1/8" BSP Straight
CN37	10 1/8" NPT 67.5°
CN39	10 1/8" BSP 67.5°
CN43	10 1/8" NPT 90°
CN44	10 1/8" GAS 90°
CN48	10 1/4" BSP Straight
CN107	25 1/4" UNF 90°
CN162	10 M8 x 1.00 Straight
CN168	25 M6 x 1.00 45°
CN173	25 M6 x 1.00 90°
CN200	10 M10 x 1.00 Straight
CN1020	25 1/4" UNF Long
CN1211	25 1/4" UNF 45°

Bulk Packs: page 126

CA2417 SOCKET HEAD CAP SCREWS	
METRIC, HIGH TENSILE GR8.8	
<i>Assortment contents listed below</i>	
M91203016	20 qty M3 x 16mm
M91203020	20 M3 x 20mm
M91203025	20 M3 x 25mm
M91203030	20 M3 x 30mm
M91204016	20 M4 x 16mm
M91204020	20 M4 x 20mm
M91204025	20 M4 x 25mm
M91204030	20 M4 x 30mm
M91205010	20 M5 x 10mm
M91205016	20 M5 x 16mm
M91205020	20 M5 x 20mm
M91205025	20 M5 x 25mm
M91205030	20 M5 x 30mm
M91206010	20 M6 x 10mm
M91206016	20 M6 x 16mm
M91206020	20 M6 x 20mm
M91206025	20 M6 x 25mm
M91206030	20 M6 x 30mm
M91206040	20 M6 x 40mm
M91208016	10 M8 x 16mm
M91208020	10 M8 x 20mm
M91208025	10 M8 x 25mm
M91208030	10 M8 x 30mm
M91208040	10 M8 x 40mm

Bulk Packs: page 149

CA2431 BOLTS & NUTS	
HEX, METRIC, HIGH TENSILE GR8.8	
C2431-1	25 / pack 6 x 20mm Set Screws
C2431-2	25 6 x 25mm Set Screws
C2431-3	25 6 x 35mm Set Screws
C2431-4	20 6 x 50mm Hex Bolts
C2431-5	20 8 x 20mm Set Screws

CA2431 BOLTS & NUTS <i>Continued</i>	
HEX, METRIC, HIGH TENSILE GR8.8	
C2431-6	20 / pk 8 x 25mm Set Screws
C2431-7	15 8 x 35mm Set Screws
C2431-8	10 8 x 50mm Bolts
C2431-9	10 10 x 25mm Set Screws
C2431-10	10 10 x 35mm Set Screws
C2431-11	10 10 x 45mm Bolts
C2431-12	10 10 x 50mm Bolts
C2431-13	8 12 x 25mm Set Screws
C2431-14	6 12 x 35mm Set Screws
C2431-15	5 12 x 45mm Bolts
C2431-16	5 12 x 50mm Bolts
C2431-17	50 M6 x 1.00mm Plain Nuts
C2431-18	50 M8 x 1.25mm Plain Nuts
C2431-19	25 M10 x 1.50mm Plain Nuts
C2431-20	15 M12 x 1.75mm Plain Nuts

CA2540 SPLIT PINS	
STEEL, ZINC PLATED	
<i>Assortment contents listed below</i>	
CPS10622	200 / pk 1.6 x 22mm
CPS10636	200 1.6 x 36mm
CPS20036	150 2.0 x 36mm
CPS20525	200 2.5 x 25mm
CPS20545	100 2.5 x 45mm
CPS30232	100 3.2 x 32mm
CPS30250	75 3.2 x 50mm
CPS40032	75 4.0 x 32mm
CPS40050	50 4.0 x 50mm
CPS50040	50 5.0 x 40mm
CPS50050	40 5.0 x 50mm
CPS60050	25 6.0 x 50mm
CPS63050	25 6.3 x 50mm
CPS70632	100 7/64 x 32
CPS70650	75 7/64 x 50mm
CPS90650	75 9/64 x 50mm

Bulk Packs: page 131

CA2700 WIRING TERMINALS	
CRIMP TYPE INCLUDING ADJUSTABLE RATCHET CRIMP TOOL	
<i>Assortment contents listed below</i>	
13-5	40 qty Ring 5mm Hole Red
201F	24 Female Bullet Blue
201M	24 Male Bullet Blue
22-5	40 Ring 5mm Hole Blue
23-10	20 Ring 4mm Hole Blue
309M	50 Male Push-On Red
309WF	50 Female Spade Fully Insul.
320M	50 Quick Connect Tab Blue
320WF	50 Quick Connect Recep. Blue
355M	40 Yellow Male Push-On
355WF	40 Yellow Female Fully Insul.
384FM	20 2 Way Blade - M/F Blue
385F	30 Spade Female 8mm Tab Blue
386F	20 Blade Female 10mm Yellow
53-6	20 15/64" Ring Yellow
53-8	30 Ring 8.2mm Hole Yellow
55-13	20 Ring 13mm Eye Yellow
TG1	40 Butt Splice Red
TG2	50 Butt Splice Blue
TG3	40 Butt Splice Yellow
277	1 Ratchet Crimping Tool

Bulk Packs: page 135

REPLACEMENT PACKS

REPLACEMENT
PACKS

CA2705 MACHINE SCREWS

METRIC, PAN HEAD, PHILLIPS, ZINC PLATED

Assortment contents listed below

CMS1	100 / pack	M3 x 10
CMS3	100	M3 x 16
CMS4	100	M3 x 20
CMS5	100	M3 x 25
CMS6	100	M3 x 30
CMS7	100	M4 x 8
CMS8	100	M4 x 10
CMS9	100	M4 x 16
CMS10	100	M4 x 20
CMS11	100	M4 x 25
CMS13	100	M5 x 10
CMS14	100	M5 x 16
CMS15	100	M5 x 20
CMS16	50	M5 x 25
CMS17	50	M5 x 35
CMS18	100	M6 x 10
CMS19	50	M6 x 16
CMS20	50	M6 x 20
CMS21	50	M6 x 25
CMS22	40	M6 x 30
CMS23	30	M6 x 35
CMS24	25	M6 x 40
CMS25	20	M6 x 45
CMS26	20	M6 x 50



Bulk Packs: page 127

CA2710 MACHINE SCREWS & NUTS

METRIC, COUNTERSUNK, PHILLIPS, ZINC PLATED

Assortment contents listed below

CMS50	100 / pack	3 x 20mm
CMS51	100	3 x 50mm
CMS52	100	4 x 16mm
CMS53	100	4 x 25mm
CMS54	100	4 x 35mm
CMS55	50	4 x 50mm
CMS56	100	5 x 20mm
CMS57	100	5 x 25mm
CMS58	50	5 x 35mm
CMS59	50	5 x 50mm
CMS60	50	5 x 60mm
CMS61	100	6 x 16mm
CMS62	100	6 x 20mm
CMS63	50	6 x 25mm
CMS64	50	6 x 40mm
CMS65	50	6 x 50mm
CMS66	50	6 x 80mm
C300-1	100	M3 x 0.5mm Hex Nuts
C300-2	100	M4 x 0.7mm Hex Nuts
C300-3	100	M5 x 0.8mm Hex Nuts
C300-4	100	M6 x 1.00mm Hex Nuts



Bulk Packs: page 127

CA2715 SEMS ASSEMBLY

HEX HEAD

Assortment contents listed below

CBP46	20 / pk	6 x 25 Combo Flat/Spring Wash
CBP48	25	12G x 3/4" Combo Flat Self-Tapp
CBP49	25	14G x 3/4" Flat Self-Tapp Black
CBP50	20	6 x 18mm Flat Washers
CBP72	20	5 x 22mm Flat Washers
CBP179	50	10 x 25 x 1.25 Flange Bolts 8.8
CBP180	50	10 x 35 x 1.25 Flange Bolts 8.8
CBP181	50	14G x 3/4" Self-Tapping Black
CBP182	50	10 x 30 Flat/Spring Washers
CBP183	50	5 x 19mm Flat Washers
CBP184	50	6 x 20 Combo Flat/Spring Wash
CBP185	50	6 x 25mm Flat/Spring Washers
CBP186	50	6 x 30 Combo Flat/Spring Wash
CBP187	50	8 x 25mm Flat Washers
CBP188	50	5 x 35mm Flat/Spring Washers
CBP189	50	6 x 12mm Flat/Spring Washers
CBP190	50	8 x 16mm Flat/Spring Washers
CBP191	50	8 x 20mm Flat/Spring Washers
CBP192	50	8 x 25mm Flat/Spring Washers
CBP193	50	8 x 30mm Flat/Spring Washers



CA2788 NYLON SET SCREWS & NUTS

HEX HEAD

C2788-1	25 / pk	M5 x 16mm
C2788-2	25	M5 x 20mm
C2788-3	25	M5 x 25mm
C2788-4	25	M5 x 30mm
C2788-5	25	M5 x 35mm
C2788-6	25	M5 x 40mm
C2788-7	25	M6 x 16mm
C2788-8	25	M6 x 20mm
C2788-9	25	M6 x 25mm
C2788-10	25	M6 x 30mm
C2788-11	25	M6 x 40mm
C2788-12	20	M6 x 50mm
C2788-13	20	M8 x 16mm
C2788-14	20	M8 x 20mm
C2788-15	20	M8 x 25mm
C2788-16	20	M8 x 30mm
C2788-17	15	M8 x 35mm
C2788-18	15	M8 x 40mm
C2788-19	10	M8 x 50mm
C2788-20	50	M5 x 0.8mm Nuts
C2788-21	50	M6 x 1.00mm Nuts
C2788-22	50	M8 x 1.25mm Nuts



CHAMPION FASTENER BULK PACKS





























SPECIAL PRICES AVAILABLE FOR STANDARD KEG AND CARTON LOTS ON ALL BULK PRODUCTS

PANEL TRIM FASTENERS

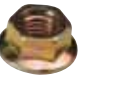

BULK PACKS

PANEL TRIM FASTENERS

 CBP02 XMAS TREE CLIPS 16 x 22mm (6.6-8.0 Hole)	 CBP03 XMAS TREE CLIPS 16 x 22mm (6.6-7.5 Hole)	 CBP04 XMAS TREE CLIPS 16 x 27mm (6.6-7.5 Hole)	 CBP05 CANOE CLIPS 11 x 26.5mm (7.5-7.6 Hole)	 CBP06 CANOE CLIPS 14 x 16mm (8.2-8.4 Hole)	 CBP07 CANOE CLIPS 14 x 16.8mm (6.6-7.8 Hole)
 CBP08 SCRIVET CLIPS 18.5 x 11.8mm (7.9-8.1 Hole)	 CBP09 BONNET ROD CLIPS 10mm	 CBP10 BONNET ROD CLIPS 7mm	 CBP11 WIRE TIES 19.5mm Open Dia.	 CBP12 SCREW GROMMETS 6.9 x 7.3mm – 6G	 CBP13 SCREW GROMMETS 8.3 x 8.3mm – 8G
 CBP14 SCREW GROMMETS 3/8" x 3/8" – 6G	 CBP15 SCREW GROMMETS 3/8" x 3/8" – 10G	 CBP16 WEATHER SEAL CLIPS Universal	 CBP17 WEATHER SEAL CLIPS Universal	 CBP18 WEATHER SEAL CLIPS Universal	 CBP19 MOULDING CLIPS Universal
 CBP20 MOULDING CLIPS Universal	 CBP21 MOULDING CLIPS Universal	 CBP22 HOLE SEALING STRAPS 6mm	 CBP23 SPEED NUTS 10G	 CBP24 SPEED NUTS 8G	 CBP25 SPEED NUTS 6G
 CBP26 SELF-TAPPING SCREWS 10G x 1"	 CBP27 SELF-TAPPING SCREWS 10G x 3/4"	 CBP28 SELF-TAPPING SCREWS 8G x 3/4"	 CBP29 SELF-TAPPING SCREWS 6G x 3/4"	 CBP30 XMAS TREE CLIPS 34.8 x 36mm (6.4-6.6 Hole)	 CBP31 XMAS TREE CLIPS 34.8 x 36mm (6.4 - 6.6 Hole)
 CBP32 XMAS TREE CLIPS 21 x 27mm (6.6-7.5 Hole)	 CBP33 XMAS TREE CLIPS 21 x 27mm (6.6-7.5 Hole)	 CBP34 ANCHOR TRIM CLIPS 18 x 16mm (12mm Hole)	 CBP35 PIPE CLIPS 9mm Head (11.7mm Hole)	 CBP36 SCREW RIVETS 22 x 9mm (8.2-10 Hole)	 CBP37 CLOSED GROMMETS 18 x 18mm (8.5-8.6 Hole)
 CBP38 MOULD CLIPS Kingswood	 CBP39 DOOR TRIM BUSH 16 x 16mm (8mm Hole)	 CBP40 UNI. DOOR TRIM BUSH 10mm	 CBP41 UNI. DOOR TRIM BUSH 10mm Dia.	 CBP42 UNI. DOOR TRIM BUSH 10 x 17mm (7mm Hole)	 CBP43 HEADLIGHT CLIPS Commodore
 CBP44 SEMS ASSEMBLY M8 x 30mm	 CBP45 HEX FLANGE NUTS M8 x 1.25mm	 CBP46 SEMS ASSEMBLY M6 x 25mm	 CBP47 HEX FLANGE NUTS M6 x 1.00mm	 CBP48 HEX SELF-TAPPING SCREWS 12G x 3/4"	 CBP49 HEX SELF-TAPPING SCREWS 14G x 3/4"









































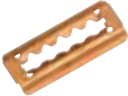







PANEL TRIM FASTENERS *Listing*

The Champion product range of Trim Clips are engineered, one piece snap-in fasteners, designed for easy installation into pre-punched holes and body panels. Manufactured from high strength engineering plastic, they are corrosion resistant and available in a variety of colours for matching trims.

PART NO.	QTY	DESCRIPTION	SIZE
CBP02	50 / pk	Xmas Tree Clips Beige	16mm Head 22mm Length 6.6 - 8.0mm Hole Size
CBP03	50	Xmas Tree Clips Grey	16mm Head 22mm Length 6.6 - 7.5mm Hole Size
CBP04	50	Xmas Tree Clips Black	16mm Head 27mm Length 6.6 - 7.5mm Hole Size
CBP05	50	Canoe Clips Black	11mm Head 26.5 Length 7.5 - 7.6mm Hole Size
CBP06	50	Canoe Clips Black	14mm Head 16mm Length 8.2 - 8.4mm Hole Size
CBP07	50	Canoe Clips Brown	14mm Head 16.8 Length 6.6 - 7.8mm Hole Size
CBP08	50	Scrivet Clips	18.5mm Head 11.8 Length 7.9 - 8.1mm Hole Size
CBP09	50	Bonnet Rod Clips	10mm
CBP10	50	Bonnet Rod Clips	7mm
CBP11	50	Wire Ties	19.5mm Open Dia.
CBP12	50	Screw Grommets Square	6.9 x 7.3mm – 6G
CBP13	50	Screw Grommets Square	8.3 x 8.3mm – 8G
CBP14	50	Screw Grommets Round	3/8" x 3/8" – 6G
CBP15	50	Screw Grommets Round	3/8" x 3/8" – 10G
CBP16	50	Weather Seal Clips	Universal
CBP17	50	Weather Seal Clips	Universal
CBP18	50	Weather Seal Clips	Universal
CBP19	50	Universal Moulding Clips	Universal
CBP20	50	Universal Moulding Clips	Universal
CBP21	50	Universal Moulding Clips	Universal
CBP22	50	Hole Sealing Straps	6mm
CBP23	100	Speed Nuts	10G
CBP24	100	Speed Nuts	8G
CBP25	100	Speed Nuts	6G

PART NO.	QTY	DESCRIPTION	SIZE
CBP26	50 / pk	Self-Tapping Screws	10G x 1"
CBP27	100	Self-Tapping Screws	10G x 3/4"
CBP28	100	Self-Tapping Screws	8G x 3/4"
CBP29	100	Self-Tapping Screws	6G x 3/4"
CBP30	50	Xmas Tree Clips Grey	34.8mm Head 36mm Length 6.4 - 6.6mm Hole Size
CBP31	50	Xmas Tree Clips Black	34.8mm Head 36mm Length 6.4 - 6.6mm Hole Size
CBP32	50	Xmas Tree Clips Grey	21mm Head 27mm Length 6.6 - 7.5mm Hole Size
CBP33	50	Xmas Tree Clips White	21mm Head 27mm Length 6.6 - 7.5mm Hole Size
CBP34	50	Anchor Trim Clips Black	18mm Head 16mm Length 12mm Hole Size
CBP35	50	Pipe Clips	9mm Head Size 11.7mm Hole Size
CBP36	50	Screw Rivets	22mm Head 9mm Length 8.2 - 10mm Hole Size
CBP37	50	Closed Grommets	18mm Head 18mm Length 8.5 - 8.6mm Hole Size
CBP38	50	Moulding Clips	Kingswood
CBP39	50	Door Trim Bush	16mm Head 16mm Length 8mm Hole Size
CBP40	50	Universal Door Trim Bush	10mm Dia.
CBP41	50	Universal Door Trim Bush	10mm Dia.
CBP42	50	Universal Door Trim Bush	10 Head 17 Length 7mm Hole Size
CBP43	50	Headlight Clips	Commodore
CBP44	50	Sems Assembly	M8 x 30mm
CBP45	50	Hex Flange Nuts	M8 x 1.25mm
CBP46	50	Sems Assembly	M6 x 25mm
CBP47	50	Hex Flange Nuts	M6 x 1.00mm
CBP48	50	Hex Self-Tapping Screws	12G x 3/4"
CBP49	50	Hex Self-Tapping Screws	14G x 3/4"

PANEL TRIM FASTENERS



 <p>CBP50 SEMS ASSEMBLY M6 x 18mm</p>	 <p>CBP51 TONNEAU HOOKS GMH</p>	 <p>CBP52 FORD TONNEAU HOOKS Ford</p>	 <p>CBP53 ROPE HOOKS Universal</p>	 <p>CBP54 MOULDING CLIPS 10 x 11mm (6mm Hole)</p>	 <p>CBP55 SCRIVET CLIPS 18 x 12.5mm (8.4-10.2 Hole)</p>
 <p>CBP56 PLASTIC PUSH RIVETS 16 x 10.4mm (7.4-8.4 Hole)</p>	 <p>CBP57 XMAS TREE CLIPS 15 x 15mm (4.9-5.1 Hole)</p>	 <p>CBP58 XMAS TREE CLIPS 14 x 15mm (6-6.8 Hole)</p>	 <p>CBP59 XMAS TREE CLIPS 16 x 15mm (5.9-6.1 Hole)</p>	 <p>CBP60 XMAS TREE CLIPS 17 x 17.5mm (6.8-7.2 Hole)</p>	 <p>CBP61 XMAS TREE CLIPS 20.2 x 15mm (6-6.8 Hole)</p>
 <p>CBP62 XMAS TREE CLIPS 20.8 x 13.5mm (6.4-6.6 Hole)</p>	 <p>CBP63 XMAS TREE CLIPS 20 x 27mm (4-6mm Hole)</p>	 <p>CBP64 BONNET INSULATION CLIPS 35 x 14mm (6mm Hole)</p>	 <p>CBP65 PLASTIC PUSH RIVETS 6 x 6.5mm (5mm Hole)</p>	 <p>CBP69 SPLASH GUARD CLIPS 26 x 14mm (9mm Hole)</p>	 <p>CBP70 GRILLE CLIPS Nissan</p>
 <p>CBP71 GRILLE CLIPS TOYOTA Toyota</p>	 <p>CBP72 HEADLIGHT BOLTS M5 x 20mm</p>	 <p>CBP73 CAPTIVE NUTS M5 x 0.8mm</p>	 <p>CBP74 SHORT CAPTIVE NUTS M6 x 1.00mm</p>	 <p>CBP75 LONG CAPTIVE NUTS M6 x 1.00mm</p>	 <p>CBP76 SHORT CAPTIVE NUTS M8 x 1.25mm</p>
 <p>CBP77 LONG CAPTIVE NUTS M8 x 1.25mm</p>	 <p>CBP78 SELF-CUTTING NUTS 1/8"</p>	 <p>CBP79 SELF-CUTTING NUTS 3/16"</p>	 <p>CBP80 BADGE CLIPS Universal</p>	 <p>CBP81 WINDOW WINDER CLIP Universal</p>	 <p>CBP82 MOULDING CLIPS Universal</p>
 <p>CBP83 RAZOR BLADE CLIPS 13.5 x 28mm</p>	 <p>CBP84 RAZOR BLADE CLIPS 16 x 30mm</p>	 <p>CBP85 CLOSED END GROMMETS 8G</p>	 <p>CBP86 PLASTIC PUSH RIVETS 9 x 4.5mm (6mm Hole)</p>	 <p>CBP87 CANOE CLIPS 13.9 x 7.6mm (4.8-5.1 Hole)</p>	 <p>CBP88 MOULDING CLIPS ASSEMBLY 14 x 11mm (8mm Hole)</p>
 <p>CBP89 BUMPER CLIPS 17 x 12mm (10mm Hole)</p>	 <p>CBP90 DOOR TRIM CLIPS 16 x 9mm</p>	 <p>CBP91 DOOR TRIM CLIPS 13 x 13mm (8mm Hole)</p>	 <p>CBP92 DOOR TRIM CLIPS 13 x 14mm (9.5mm Hole)</p>	 <p>CBP93 RETAINER CLIPS Universal</p>	 <p>CBP94 TONNEAU HOOKS Universal</p>
 <p>CBP98 TONNEAU CORDS Universal</p>	 <p>CBP99 HOLE MOUNTED CABLE TIES 6.7mm Hole Size</p>	 <p>CBP100 RETAINER CLIPS 13 x 9.5mm (6mm Hole)</p>	 <p>CBP101 CANOE CLIPS 9.5 x 11.1mm (4.6-4.8 Hole)</p>	 <p>CBP102 CANOE CLIPS 9.6 x 13.4mm (4.6-4.8 Hole)</p>	 <p>CBP103 MOULDING CLIPS 11 x 12mm (4mm Hole)</p>

PANEL TRIM FASTENERS *Listing*

PART NO.	QTY	DESCRIPTION	SIZE
CBP50	50/pk	Sems Assembly	M6 x 18mm
CBP51	50	Tonneau Hooks	GMH
CBP52	50	Tonneau Hooks	Ford
CBP53	50	Rope Hooks	Universal
CBP54	50	Scrivet Clips	10mm Head 11mm Length 6mm Hole Size
CBP55	50	Scrivet Clips Black	18mm Head 12.5mm Length 8.4 - 10.2mm Hole Size
CBP56	50	Plastic Push Rivets	16mm Head 10.4mm Length 7.4 - 8.4mm Hole Size
CBP57	50	Xmas Tree Clips Black	15mm Head 15mm Length 4.9 - 5.1mm Hole Size
CBP58	50	Xmas Tree Clips Black	14mm Head 15mm Length 6.0 - 6.8mm Hole Size
CBP59	50	Xmas Tree Clips Black	16mm Head 15mm Length 5.9 - 6.1mm Hole Size
CBP60	50	Xmas Tree Clips Black	17mm Head 17.5mm Length 6.8 - 7.2mm Hole Size
CBP61	50	Xmas Tree Clips Black	20.2mm Head 15mm Length 6.0 - 6.8mm Hole Size
CBP62	50	Xmas Tree Clips Black	20.8mm Head 13.5mm Length 6.4 - 6.6mm Hole Size
CBP63	50	Xmas Tree Clips Black	20mm Head 27mm Length 4 - 6mm Hole Size
CBP64	50	Bonnet Insulation Clips	35mm Head 14mm Length 6mm Hole Size
CBP65	50	Plastic Push Rivets	6mm Head 6.5mm Length 5mm Hole Size
CBP69	50	Splash Guard Clips	26mm Head 14mm Length 9mm Hole Size
CBP70	50	Grille Clips	Nissan
CBP71	50	Grille Clips	Toyota
CBP72	50	Headlight Bolts	M5 x 20mm
CBP73	50	Captive Nuts	M5 x 0.8mm
CBP74	50	Short Captive Nuts	M6 x 1.00mm
CBP75	50	Long Captive Nuts	M6 x 1.00mm
CBP76	50	Short Captive Nuts	M8 x 1.25mm

PART NO.	QTY	DESCRIPTION	SIZE
CBP77	50/pk	Long Captive Nuts	M8 x 1.25mm
CBP78	50	Self-Cutting Nuts	1/8"
CBP79	50	Self-Cutting Nuts	3/16"
CBP80	50	Badge Clips	Universal
CBP81	50	Window Winder Clips	Universal
CBP82	50	Moulding Clips Metal	Universal
CBP83	50	Razor Blade Clips	13.5mm Head 28mm Length
CBP84	50	Razor Blade Clips	16mm Head 30mm Length
CBP85	50	Closed End Grommets	8G
CBP86	50	Plastic Push Rivets	9mm Head 4.5mm Length 6mm Hole Size
CBP87	50	Canoe Clips	13.9mm Head 7.6mm Length 4.8 - 5.1mm Hole Size
CBP88	50	Moulding Clips Assembly	14mm Head 11mm Length 8mm Hole Size
CBP89	50	Bumper Clips	17mm Head 12mm Length 10mm Hole Size
CBP90	50	Door Trim Clips	16mm Head 9mm Length
CBP91	50	Door Trim Clips	13mm Head 13mm Length 8mm Hole Size
CBP92	50	Door Trim Clips	13mm Head 14mm Length 9.5mm Hole Size
CBP93	50	Retainer Clips	Universal
CBP94	50	Tonneau Hooks	Universal
CBP98	50	Tonneau Cords	Universal
CBP99	50	Hole Mounted Cable Ties	6.7mm Hole Size
CBP100	50	Retainer Clips	13mm Head 9.5mm Length 6mm Hole Size
CBP101	50	Canoe Clips	9.5mm Head 11.1 Length 4.6 - 4.8mm Hole Size
CBP102	50	Canoe Clips	9.6mm Head 13.4 Length 4.6 - 4.8mm Hole Size
CBP103	50	Moulding Clips	11mm Head 12mm Length 4mm Hole Size

PANEL TRIM FASTENERS

 <p>CBP104 CANOE CLIPS 14.2 x 15.2mm (5.5-5.7 Hole)</p>	 <p>CBP105 XMAS TREE CLIPS 12 x 15mm (4.8-5.1mm Hole)</p>	 <p>CBP151 BUTTON STUDS Male Set</p>	 <p>CBP152 BUTTON STUDS Female Set</p>	 <p>CBP153 STUD SOCKETS Set (suits CBP 155)</p>	 <p>CBP154 STUD EYELETS Set (suits CBP 156)</p>
 <p>CBP155 STUD FASTENERS Set (suits CBP 153)</p>	 <p>CBP156 STUD FASTENERS Suits CBP 154</p>	 <p>CBP157 PUSH RIVETS 11 x 18mm (6mm Hole)</p>	 <p>CBP158 XMAS TREE CLIPS 25 x 24mm (6.8mm Hole)</p>	 <p>CBP159 FENDER PROTECTOR CLIPS</p>	 <p>CBP160 SCRIVET CLIPS 20 x 18mm (8mm Hole)</p>
 <p>CBP161 SCRIVET CLIPS 20 x 27mm (8mm Hole)</p>	 <p>CBP162 SCRIVET CLIPS 18 x 12mm (8mm Hole)</p>	 <p>CBP163 PUSH RIVETS 18 x 28mm (9mm Hole)</p>	 <p>CBP164 PUSH RIVETS 20 x 13mm (10mm Hole)</p>	 <p>CBP165 PUSH RIVETS 20 x 11mm (8mm Hole)</p>	 <p>CBP166 SCRIVET CLIPS 17 x 10mm (7mm Hole)</p>
 <p>CBP167 SCRIVET CLIPS 15 x 20mm (8mm Hole)</p>	 <p>CBP168 SCRIVET CLIPS 20 x 20mm (8mm Hole)</p>	 <p>CBP169 PUSH RIVETS 20 x 9mm (8mm Hole)</p>	 <p>CBP170 PUSH RIVETS 18 x 7mm (7mm Hole)</p>	 <p>CBP171 PUSH RIVETS 14 x 14mm (6mm Hole)</p>	 <p>CBP172 PUSH RIVETS 15 x 17mm (6mm Hole)</p>
 <p>CBP173 XMAS TREE CLIPS 17 x 20mm (7mm Hole)</p>	 <p>CBP174 XMAS TREE CLIPS 18 x 26mm (7mm Hole)</p>	 <p>CBP175 XMAS TREE CLIPS 25 x 32mm (8mm Hole)</p>	 <p>CBP176 XMAS TREE CLIPS 15/16" x 19mm (9mm Hole)</p>	 <p>CBP177 XMAS TREE CLIPS 18 x 35mm (8mm Hole)</p>	 <p>CBP178 XMAS TREE CLIPS 18 x 20mm (6.8mm Hole)</p>
 <p>CBP179 HEX FLANGE BOLTS 8.8 10 x 25 x 1.25mm</p>	 <p>CBP180 HEX FLANGE BOLTS 8.8 10 x 35 x 1.25mm</p>	 <p>CBP181 HEX SELF-TAPPING 14G x 3/4"</p>	 <p>CBP182 SEMS, FLAT/SPRING WASH 10 x 30mm</p>	 <p>CBP183 SEMS, HEX, FLAT WASHER 5 x 19mm</p>	 <p>CBP184 SEMS, HEX, COMBO, FLAT/SPRING WASHER 6 x 20mm</p>
 <p>CBP185 SEMS, HEX, COMBO, FLAT/SPRING WASHER 6 x 25mm</p>	 <p>CBP186 SEMS, HEX, COMBO, FLAT/SPRING WASHER 6 x 30mm</p>	 <p>CBP187 SEMS, HEX, FLAT WASHER 8 x 25mm</p>	 <p>CBP188 SEMS, HEX, COMBO, FLAT/SPRING WASHER 5 x 35mm</p>	 <p>CBP189 SEMS, HEX, FLAT/SPRING WASHER 6 x 12mm</p>	 <p>CBP190 SEMS, HEX, FLAT/SPRING WASHER 8 x 16mm</p>
 <p>CBP191 SEMS, HEX, FLAT/SPRING WASHER 8 x 20mm</p>	 <p>CBP192 SEMS, HEX, FLAT/SPRING WASHER 8 x 25mm</p>	 <p>CBP193 SEMS, HEX, FLAT/SPRING WASHER 8 x 30mm</p>	 <p>RT6834 TRIM CLIP REMOVER TOOL Well designed tool removes trim clips in just a few seconds. Place the tool under the edge of the trim fastener, then just pry upwards.</p>		

PANEL TRIM FASTENERS *Listing*

PART NO.	QTY	DESCRIPTION	SIZE	
CBP104	50 / pk	Canoe Clips	14.2mm Head	15.2mm Length
			5.5 - 5.7mm Hole Size	
CBP105	50	Xmas Tree Clips	12mm Head	15mm Length
			4.8 - 5.1mm Hole Size	
CBP151	50	Button Studs	Male Set	
CBP152	50	Button Studs	Female Set	
CBP153	50	Stud Sockets	Set (suits CBP 155)	
CBP154	50	Stud Eyelets	Set (suits CBP 156)	
CBP155	50	Stud Fasteners	8G (suits CBP 153)	
CBP156	50	Stud Fasteners	Suits CBP 154	
CBP157	50	Push Rivets	11mm Head	18mm Length
			6mm Hole Size	
CBP158	50	Xmas Tree Clips	25mm Head	24mm Length
			6.8mm Hole Size	
CBP159	50	Fender Protector Clips		
CBP160	50	Scrivet Clips	20mm Head	18mm Length
			8mm Hole Size	
CBP161	50	Scrivet Clips	20mm Head	27mm Length
			8mm Hole Size	
CBP162	50	Scrivet Clips	18mm Head	12mm Length
			8mm Hole Size	
CBP163	50	Push Rivets	18mm Head	28mm Length
			9mm Hole Size	
CBP164	50	Push Rivets	20mm Head	13mm Length
			10mm Hole Size	
CBP165	50	Push Rivets	20mm Head	11mm Length
			8mm Hole Size	
CBP166	50	Scrivet Clips	17mm Head	10mm Length
			7mm Hole Size	
CBP167	50	Scrivet Clips	15mm Head	20mm Length
			8mm Hole Size	
CBP168	50	Scrivet Clips	20mm Head	20mm Length
			8mm Hole Size	
CBP169	50	Push Rivets	20mm Head	9mm Length
			8mm Hole Size	
CBP170	50	Push Rivets	18mm Head	7mm Length
			7mm Hole Size	
CBP171	50	Push Rivets	14mm Head	14mm Length
			6mm Hole Size	

PART NO.	QTY	DESCRIPTION	SIZE	
CBP172	50 / pk	Push Rivets	15mm Head	17mm Length
			6mm Hole Size	
CBP173	50	Xmas Tree Clips	17mm Head	20mm Length
			7mm Hole Size	
CBP174	50	Xmas Tree Clips	18mm Head	26mm Length
			7mm Hole Size	
CBP175	50	Xmas Tree Clips	25mm Head	32mm Length
			8mm Hole Size	
CBP176	50	Xmas Tree Clips	15/16" Head	19mm Length
			9mm Hole Size	
CBP177	50	Xmas Tree Clips	18mm Head	35mm Length
			8mm Hole Size	
CBP178	50	Xmas Tree Clips	18mm Head	20mm Length
			6.8mm Hole Size	
CBP179	50	Hex Flange Bolts 8.8	10 x 25 x 1.25mm	
CBP180	50	Hex Flange Bolts 8.8	10 x 35 x 1.25mm	
CBP181	50	Hex Self-Tapping	14G x 3/4"	
CBP182	50	Sems, Flat/Spring Washers	10 x 30mm	
CBP183	50	Sems, Hex, Flat Washers	5 x 19mm	
CBP184	50	Sems, Hex, Combo, Flat/Spring Washers	6 x 20mm	
CBP185	50	Sems, Hex, Combo, Flat/Spring Washers	6 x 25mm	
CBP186	50	Sems, Hex, Combo, Flat/Spring Washers	6 x 30mm	
CBP187	50	Sems, Hex, Flat Washers	8 x 25mm	
CBP188	50	Sems, Hex, Combo, Flat/Spring Washers	5 x 35mm	
CBP189	50	Sems, Hex, Flat/Spring Washers	6 x 12mm	
CBP190	50	Sems, Hex, Flat/Spring Washers	8 x 16mm	
CBP191	50	Sems, Hex, Flat/Spring Washers	8 x 20mm	
CBP192	50	Sems, Hex, Flat/Spring Washers	8 x 25mm	
CBP193	50	Sems, Hex, Flat/Spring Washers	8 x 30mm	

BATTERY BOLTS		
ZINC PLATED		
BNB1	50 / pack	5/16 x 1-1/4"
BNB2	50	5/16 x 1-1/2"
BNB3	50	1/4 x 1/2"
BNB4	50	6 x 16mm
BNB11	10	5/16 x 1-1/4"
BNB12	10	5/16 x 1-1/2"
BNB13	10	1/4 x 1/2"
BNB14	10	6 x 16mm



CIRCLIPS		
METRIC, INTERNAL		
D1300-8	100 / pack	8mm
D1300-10	100	10mm
D1300-12	100	12mm
D1300-14	50	14mm
D1300-15	50	15mm
D1300-16	50	16mm
D1300-18	50	18mm
D1300-20	50	20mm
D1300-22	25	22mm
D1300-24	25	24mm
D1300-25	25	25mm
D1300-26	25	26mm
D1300-28	25	28mm
D1300-30	25	30mm
D1300-32	25	32mm
D1300-35	25	35mm
D1300-40	25	40mm
D1300-42	25	42mm
D1300-45	25	45mm
D1300-50	25	50mm



CIRCLIPS		
METRIC, EXTERNAL		
D1400-6	100 / pack	6mm
D1400-8	100	8mm
D1400-10	100	10mm
D1400-12	100	12mm
D1400-14	50	14mm
D1400-15	50	15mm
D1400-16	50	16mm
D1400-18	50	18mm
D1400-20	50	20mm
D1400-22	25	22mm
D1400-24	25	24mm
D1400-25	25	25mm
D1400-26	25	26mm
D1400-28	25	28mm
D1400-30	25	30mm
D1400-32	25	32mm
D1400-35	25	35mm
D1400-40	25	40mm
D1400-45	25	45mm
D1400-50	25	50mm



CIRCLIPS		
IMPERIAL, INTERNAL		
N1300-4	100 / pack	1/4"
N1300-5	100	5/16"
N1300-6	100	3/8"
N1300-8	100	1/2"
N1300-10	50	5/8"
N1300-12	50	3/4"
N1300-14	50	7/8"
N1300-16	25	1"
N1300-17	25	1-1/16"
N1300-18	25	1-1/8"
N1300-19	25	1-3/16"
N1300-20	25	1-1/4"
N1300-21	25	1-5/16"
N1300-22	25	1-3/8"
N1300-23	25	1-7/16"
N1300-24	25	1-1/2"
N1300-26	25	1-5/8"
N1300-28	25	1-3/4"
N1300-30	25	1-7/8"
N1300-32	25	2"





CIRCLIPS		
IMPERIAL, EXTERNAL		
N1400-4	100 / pack	1/4"
N1400-5	100	5/16"
N1400-6	100	3/8"
N1400-7	100	7/16"
N1400-8	100	1/2"
N1400-10	50	5/8"
N1400-12	50	3/4"
N1400-14	50	7/8"
N1400-16	25	1"
N1400-17	25	1-1/16"
N1400-18	25	1-1/8"
N1400-19	25	1-3/16"
N1400-20	25	1-1/4"
N1400-21	25	1-5/16"
N1400-22	25	1-3/8"
N1400-23	25	1-7/16"
N1400-24	25	1-1/2"
N1400-26	25	1-5/8"
N1400-28	25	1-3/4"
N1400-30	25	1-7/8"
N1400-32	25	2"





CLEVIS PINS		
ZINC PLATED		
CCP5	25 / pack	1/4 x 1"
CCP10	25	5/16 x 15/16"
CCP11	25	5/16 x 1"
CCP18	25	5/16 x 1-1/4"
CCP19	25	5/16 x 1-3/4"
CCP25	25	3/8 x 1"
CCP27	25	3/8 x 1-1/8"
CCP36	25	3/8 x 2"
CCP43	25	7/16 x 1-1/2"
CCP48	25	1/2 x 1-3/4"





DRAIN (SUMP) PLUGS			
WITH WASHERS			
DP1	10 / pack	No.1 - 1/2" UNF Plug	
DP10S	10	No.10/S - 1/2+ .028" Plug	
DP3	10	No.3 - 5/8" UNF Plug	
DP12	10	No.12 - M12 x 1.5 Plug	
DP12C	10	No.12C - 12 x 1.75mm Plug	
DP12F	10	No.12F - M12 x 1.25 Plug	
DP14	10	No.14 - M14 x 1.5 Plug	
DP16	10	No.16 - 3/8" BSPP	
DP18	5	No.18 - M18 x 1.5 Plug	
DP25	5	No.25 - M25 x 1.5 Plug	



DRAIN (SUMP) PLUG WASHERS			
ALUMINIUM			
CAW1218	50 / pack	12 x 18 x 1.5mm	
CAW1420	50	14 x 20 x 1.5mm	
CAW1622	50	16 x 22 x 1.5mm	
CAW1824	50	18 x 24 x 1.5mm	
CAW2024	50	20 x 24 x 1.5mm	
CAW2227	50	22 x 27 x 1.5mm	
CAW2229	50	22 x 29 x 1.5mm	
CAW2430	50	24 x 30 x 1.8mm	



DRAIN (SUMP) PLUG WASHERS			
BLACK FIBRE			
CFW31	25 / pack	12 x 24 x 2.00	
CFW32	25	18 x 28 x 2.00	

DRAIN (SUMP) PLUG WASHERS			
COPPER CRUSH			
CWC1218	20 / pack	12 x 18mm	
CWC1622	20	16 x 22mm	

DRAIN (SUMP) PLUG WASHERS			
WHITE FIBRE			
CFW1224	25 / pack	12 x 24 x 2.00	
CFW1622	25	16 x 22 x 2.00	
CFW1828	25	18 x 28 x 2.00	
CFW2535	25	25 x 35 x 2.00	

'E' CLIPS			
STEEL			
C1500-9	100 / pack	Suit 3/32" Shaft	
C1500-12	100	Suit 1/8" Shaft	
C1500-15	100	Suit 5/32" Shaft	
C1500-18	100	Suit 3/16" Shaft	
C1500-25	100	Suit 1/4" Shaft	
C1500-31	100	Suit 5/16" Shaft	
C1500-37	100	Suit 3/8" Shaft	
C1500-43	100	Suit 7/16" Shaft	
C1500-50	100	Suit 1/2" Shaft	
C1500-62	100	Suit 5/8" Shaft	

FUSES - AUTO			
AF3	50 / pack	3 Amp Blade	
AF5	50	5 Amp Blade	
AF7.5	50	7.5 Amp Blade	
AF10	50	10 Amp Blade	
AF15	50	15 Amp Blade	
AF20	50	20 Amp Blade	
AF25	50	25 Amp Blade	
AF30	50	30 Amp Blade	
6AC8	50	6AC 8 Amp European	
6AC16	50	6AC 16 Amp European	
6AC25	50	6AC 25 Amp European	
1AG2	50	1AG 2 Amp Glass	
1AG5	50	1AG 5 Amp Glass	
2AG7.5	50	2AG 7.5 Amp Glass	
3AG2	50	3AG 2 Amp Glass	
3AG3	50	3AG 3 Amp Glass	
3AG5	50	3AG 5 Amp Glass	
3AG7.5	50	3AG 7.5 Amp Glass	
3AG10	50	3AG 10 Amp Glass	
3AG15	50	3AG 15 Amp Glass	
3AG20	50	3AG 20 Amp Glass	
3AG25	50	3AG 25 Amp Glass	
3AG30	50	3AG 30 Amp Glass	
3AG35	50	3AG 35 Amp Glass	
SFE14	50	SFE 14 Amp Glass	

GREASE NIPPLES			
PACKS OF 25			
CN1	25 / pack	1/4" BSF Straight	
CN3	25	1/4" UNF Straight	
CN8	25	1/4" BSF 67-1/2°	
CN12	25	5/16" BSF Straight	
CN15	25	8 x 1.25mm Straight	
CN19	25	8 x 1.25mm 45°	
CN20	25	5/16" BSF 67-1/2°	
CN27	25	8 x 1.25mm 90°	
CN28	25	1/8" NPT Straight	
CN29	25	1/8" BSP Straight	
CN37	25	1/8" NPT 67-1/2°	
CN39	25	1/8" BSP 67-1/2°	
CN43	25	1/8" NPT 90°	
CN44	25	1/8" BSP 90°	
CN48	25	1/4" BSP Straight	
CN60	25	1/4" BSP 90°	
CN107	25	1/4" UNF 90°	
CN161	25	6 x 1mm Straight	
CN162	25	8 x 1mm Straight	
CN163	25	M6 Self-Tapp Straight	
CN168	25	6 x 1mm 45°	
CN169	25	8 x 1mm 90°	
CN172	25	8 x 1mm 45°	
CN173	25	6 x 1mm 90°	
CN200	25	10 x 1mm Straight	
CN203	25	10 x 1mm 45°	
CN204	25	10 x 1mm 90°	
CN1020	25	1/4" UNF x 1-1/4" Long	
CN1210	25	1/8" BSP 45°	
CN1211	25	1/4" UNF 45°	

GREASE NIPPLES		
BOXED QUANTITIES		
CGN1	100 / pack	1/4" BSF Straight
CGN3	100	1/4" UNF Straight
CGN8	100	1/4" BSF 67.5°
CGN12	100	5/16" BSF Straight
CGN15	100	8 x 1.25mm Straight
CGN19	100	8 x 1.25mm 45°
CGN20	100	5/16" BSF 67.5°
CGN27	100	8 x 1.25mm 90°
CGN28	100	1/8" NPT Straight
CGN29	100	1/8" BSP Straight
CGN37	100	1/8" NPT 67.5°
CGN39	100	1/8" BSP 67.5°
CGN43	100	1/8" NPT 90°
CGN44	100	1/8" BSP 90°
CGN48	50	1/4" BSP Straight
CGN60	50	1/4" BSP 90°
CGN107	100	1/4" UNF 90°
CGN161	100	6 x 1mm Straight
CGN162	100	8 x 1mm Straight
CGN163	100	6mm Self-Tapp Straight
CGN168	100	6 x 1mm 45°
CGN169	100	8 x 1mm 90°
CGN172	100	8 x 1mm 45°
CGN173	100	6 x 1mm 90°
CGN200	100	10 x 1mm Straight
CGN203	100	10 x 1mm 45°
CGN204	100	10 x 1mm 90°
CGN1020	100	1/4" UNF x 1-1/4" Long
CGN1210	100	1/8" BSP 45°
CGN1211	100	1/4" UNF 45°



GREASE NIPPLES – STAINLESS STEEL 316/A4		
PACKS OF 25		
SSCN1	25 / pack	1/4" BSF Straight
SSCN3	25	1/4" UNF Straight
SSCN28	25	1/8" NPT Straight
SSCN29	25	1/8" BSP Straight
SSCN43	25	1/8" NPT 90°
SSCN44	25	1/8" BSP 90°
SSCN1020	25	1/4 x 1-1/4" UNF
SSCN1211	25	1/4" UNF 45°
SSCN15	25	M8 x 1.25mm Straight
SSCN161	25	M6 x 1.00mm Straight
SSCN162	25	M8 x 1.00mm Straight
SSCN168	25	M6 x 1.00mm 45°
SSCN173	25	M6 x 1.00mm 90°
SSCN200	25	10 x 1.00mm Straight



GROMMETS				
ELECTRICAL WIRING (RUBBER)				
		I.D.	PANEL HOLE	O.D.
CWG1	50/pk	1/8"	x 9/32"	x 7/16"
CWG2	50	3/16"	x 5/16"	x 7/16"
CWG3	50	1/4"	x 1/2"	x 9/16"
CWG4	50	5/16"	x 17/32"	x 3/4"
CWG5	50	3/8"	x 1/2"	x 11/16"
CWG6	50	3/8"	x 9/16"	x 11/16"
CWG7	50	3/8"	x 3/4"	x 1"
CWG8	50	7/16"	x 3/4"	x 1"
CWG9	50	1/2"	x 21/32"	x 13/16"
CWG10	25	5/8"	x 1"	x 1-1/8"
CWG11	25	3/4"	x 15/16"	x 1-5/16"
CWG12	25	29/32"	x 1-1/4"	x 1-1/2"



GROMMETS		
RUBBER BLANKING		
		PANEL HOLE
CBG1	50 / pack	5/16"
CBG2	50	3/8"
CBG3	50	1/2"
CBG4	50	5/8"
CBG5	25	3/4"
CBG6	25	7/8"
CBG7	25	1"
CBG8	25	1-1/8"



HEADER (MANIFOLD) BOLTS		
7/16" AF		
CHB1	100 / pack	3/8 x 1" UNC
CHB11	25	3/8 x 1" UNC



LOCK RINGS		
EXTERNAL, SPN TYPE		
SPN1.5	100 / pack	1.5mm
SPN2	100	2mm
SPN2.4	100	2.4mm
SPN3	100	3mm
SPN4	100	4mm
SPN5	100	5mm
SPN6	100	6mm
SPN8	100	8mm
SPN10	100	10mm
SPN12	50	12mm



LYNCH PINS		
CLP1	2 / pack	4mm Dia.
CLP2	2	6mm Dia.
CLP3	2	8mm Dia.
CLP4	2	10mm Dia.



MACHINE SCREWS

PAN HEAD PHILLIPS, METRIC, ZINC PLATED

CMS1	100 / pack	3 x 10mm	
CMS3	100	3 x 16mm	
CMS4	100	3 x 20mm	
CMS5	100	3 x 25mm	
CMS6	100	3 x 30mm	
CMS7	100	4 x 8mm	
CMS8	100	4 x 10mm	
CMS9	100	4 x 16mm	
CMS10	100	4 x 20mm	
CMS11	100	4 x 25mm	
CMS12	100	4 x 80mm	
CMS13	100	5 x 10mm	
CMS14	100	5 x 16mm	
CMS15	100	5 x 20mm	
CMS16	100	5 x 25mm	
CMS17	100	5 x 35mm	
CMS18	100	6 x 10mm	
CMS19	100	6 x 16mm	
CMS20	100	6 x 20mm	
CMS21	100	6 x 25mm	
CMS22	100	6 x 30mm	
CMS23	100	6 x 35mm	
CMS24	100	6 x 40mm	
CMS25	100	6 x 45mm	
CMS26	50	6 x 50mm	
CMS27	50	6 x 55mm	
CMS28	50	6 x 60mm	
CMS29	50	6 x 65mm	
CMS30	50	6 x 70mm	
CMS31	50	6 x 80mm	

MACHINE SCREWS

COUNTERSUNK PHILLIPS, ZINC PLATED

CMS50	100 / pack	3 x 20mm	
CMS51	100	3 x 50mm	
CMS52	100	4 x 16mm	
CMS53	100	4 x 25mm	
CMS54	100	4 x 35mm	
CMS55	50	4 x 50mm	
CMS56	100	5 x 20mm	
CMS57	100	5 x 25mm	
CMS58	50	5 x 35mm	
CMS59	50	5 x 50mm	
CMS60	50	5 x 60mm	
CMS61	100	6 x 16mm	
CMS62	100	6 x 20mm	
CMS63	50	6 x 25mm	
CMS64	50	6 x 40mm	
CMS65	50	6 x 50mm	
CMS66	50	6 x 80mm	

MANIFOLD NUTS

BRASS

CMN101	25 / pack	1/4" UNC	
CMN102	25	5/16" UNC	
CMN103	25	3/8" UNC	
CMN104	25	7/16" UNC	
CMN105	25	1/4" BSF	
CMN106	25	5/16" BSF	
CMN107	25	3/8" BSF	
CMN109	25	1/4" UNF	
CMN110	25	5/16" UNF	
CMN112	25	3/8" UNF	
CMN113	25	7/16" UNF	
CMN115	25	6 x 0.75mm	
CMN116	25	6 x 1.00mm	
CMN117	25	8 x 1.00mm	
CMN118	25	8 x 1.25mm	
CMN119	25	10 x 1.25mm	
CMN120	25	10 x 1.5mm	

MANIFOLD STUDS & NUTS

STEEL

MS1	25 / pack	3/8 x 2" UNC Studs	
MS2	25	M8 x 38 x 1.25mm Studs	
MS3	25	7/16 x 2-1/4" UNC Studs	
MS4	25	M10 x 41 x 1.25mm Studs	
MS6	25	M10 x 40 x 1.50mm Studs	
MS11	25	3/8" UNC Nuts	
MS12	25	M8 x 1.25mm Nuts	
MS13	25	7/16" UNC Nuts	
MS14	25	M10 x 1.25mm Nuts	
MS15	25	M10 x 1.5mm Nuts	

MANIFOLD STUDS & NUTS

STEEL & BRASS

CDNN1	10 / pack	M8 x 1.25mm Nut Brass	
CDNN2	10	M8 x 1.25mm Nut Steel	
CDNS1	10	M8 x 38 x 1.25mm Studs	
CDNS2	10	M8 x 50 x 1.25mm Studs	
CFDN1	10	7/16" UNC Nuts Brass	
CFDN2	10	7/16" UNC Nuts Steel	
CFDS1	10	7/16 x 2-1/4" UNC Studs	
CFDS2	10	M10 x 40 x 1.5mm Studs	
CGMN1	10	3/8" UNC Nuts Brass	
CGMN3	10	3/8" UNC Nuts Steel	
CGMS1	10	3/8 x 2" UNC Studs	
CGMS3	10	M10 x 41 x 1.25mm Studs	
CMNS1	10	M10 x 1.5mm Nut Steel	
CMNS2	10	M10 x 1.5mm Nut Brass	
CTYN1	10	M10 x 1.25mm Nut Brass	
CTYN2	10	M10 x 1.25mm Nut Steel	
CTYNS1	10	M10 x 41 x 1.25mm Studs	
CUNIV1	10	M10 x 1.25 x 1.50 x 50mm	

'O' RINGS				
IMPERIAL, 70 SHORE				
		I.D.		SECTION
COR101	50 / pack	1/8"	x	1/16"
COR102	50	3/16"	x	1/16"
COR103	50	1/4"	x	1/16"
COR104	50	5/16"	x	1/16"
COR105	50	3/8"	x	1/16"
COR106	50	3/8"	x	3/32"
COR107	50	7/16"	x	3/32"
COR108	50	1/2"	x	1/16"
COR109	50	1/2"	x	3/32"
COR110	50	9/16"	x	3/32"
COR111	50	5/8"	x	3/32"
COR112	50	11/16"	x	3/32"
COR113	50	3/4"	x	3/32"
COR114	50	3/4"	x	1/8"
COR115	50	13/16"	x	3/32"
COR116	50	13/16"	x	1/8"
COR117	50	7/8"	x	3/32"
COR118	50	7/8"	x	1/8"
COR119	50	15/16"	x	1/8"
COR120	50	1"	x	1/8"
COR121	25	1-1/16"	x	1/8"
COR122	25	1-1/8"	x	1/8"
COR123	25	1-3/16"	x	1/8"
COR124	25	1-1/4"	x	1/8"
COR125	25	1-5/16"	x	1/8"
COR126	25	1-3/8"	x	1/8"
COR127	25	1-7/16"	x	1/8"
COR128	25	1-1/2"	x	1/8"
COR129	25	1-5/8"	x	1/8"
COR130	25	1-3/4"	x	1/8"
COR131	25	1-7/8"	x	1/8"
COR132	25	2"	x	1/8"



'O' RINGS				
METRIC, 70 SHORE				
		I.D.		SECTION
COR201	50 / pack	3mm	x	2mm
COR202	50	5mm	x	2mm
COR203	50	6mm	x	2mm
COR204	50	7mm	x	2mm
COR205	50	8mm	x	2mm
COR206	50	9mm	x	2mm
COR207	50	10mm	x	2mm
COR208	50	10mm	x	2.5mm
COR209	50	11mm	x	2.5mm
COR210	50	12mm	x	2.5mm
COR211	50	13mm	x	2mm
COR212	50	13mm	x	2.5mm
COR213	50	14mm	x	2.5mm
COR214	50	15mm	x	2.5mm
COR215	50	16mm	x	2.5mm



'O' RINGS <i>Continued</i>				
METRIC, 70 SHORE				
		I.D.		SECTION
COR216	50 / pack	17mm	x	2.5mm
COR217	50	18mm	x	2.5mm
COR218	50	18mm	x	3.5mm
COR219	50	19mm	x	2.5mm
COR220	50	20mm	x	2.5mm
COR221	50	20mm	x	3.5mm
COR222	50	21mm	x	2.5mm
COR223	50	22mm	x	2.5mm
COR224	50	22mm	x	3.5mm
COR225	50	23mm	x	3.5mm
COR226	50	25mm	x	3.5mm
COR227	25	27mm	x	3.5mm
COR228	25	28mm	x	3.5mm
COR229	25	30mm	x	3.5mm
COR230	25	31mm	x	3.5mm
COR231	25	32mm	x	3.5mm
COR232	25	34mm	x	3.5mm
COR233	25	36mm	x	3.5mm
COR234	25	38mm	x	3.5mm
COR235	25	41mm	x	3.5mm
COR236	25	44mm	x	3.5mm
COR237	25	46mm	x	3.5mm
COR238	25	50mm	x	3.5mm



'R' CLIPS				
ZINC PLATED				
		TO SUIT SHAFT – Dia.		
RCL1	100 / pack	1/8"	to	3/16"
RCL2	100	3/16"	to	1/4"
RCL4	100	1/4"	to	3/8"
RCL5	100	5/16"	to	1/2"
RCL6	100	3/8"	to	1/2"
RCL8	50	7/16"	to	3/4"
RCL10	50	5/8"	to	7/8"
RCL12	25	3/4"	to	1"



RETAINER SPRINGS				
C1100-8	100 / pack	Suit 11/64" Shaft		
C1100-12	100	Suit 7/32" Shaft		
C1100-21	100	Suit 19/64" Shaft		
C1100-37	100	Suit 17/32" Shaft		



RIVETS				
ALUMINIUM, BLIND, ZINC PLATED				
CAR329	100 / pack	3/32 x 0.290" Short		
CAR429	100	1/8 x 0.290" Short		
CAR440	100	1/8 x 0.400" Medium		
CAR450	100	1/8 x 0.500" Long		
CAR529	100	5/32 x 0.290" Short		
CAR545	100	5/32 x 0.450" Medium		
CAR550	100	5/32 x 0.500" Long		
CAR635	100	3/16 x 0.350" Short		
CAR649	100	3/16 x 0.490" Medium		
CAR657	100	3/16 x 0.570" Long		



ROLL PINS

IMPERIAL

RP016127	100 / pack	1/16 x 1/2"
RP024127	100	3/32 x 1/2"
RP024159	100	3/32 x 5/8"
RP024190	100	3/32 x 3/4"
RP024254	100	3/32 x 1"
RP032095	100	1/8 x 3/8"
RP032127	100	1/8 x 1/2"
RP032159	100	1/8 x 5/8"
RP032190	100	1/8 x 3/4"
RP032222	100	1/8 x 7/8"
RP032254	100	1/8 x 1"
RP040127	100	5/32 x 1/2"
RP040254	100	5/32 x 1"
RP048190	100	3/16 x 3/4"
RP048254	100	3/16 x 1"
RP048318	100	3/16 x 1-1/4"
RP048380	100	3/16 x 1-1/2"
RP048508	100	3/16 x 2"
RP048636	100	3/16 x 2-1/2"
RP064254	100	1/4 x 1"
RP064380	100	1/4 x 1-1/2"
RP064508	50	1/4 x 2"
RP064636	50	1/4 x 2-1/2"
RP080380	50	5/16 x 1-1/2"
RP080508	50	5/16 x 2"
RP080636	50	5/16 x 2-1/2"
RP096508	50	3/8 x 2"
RP096636	50	3/8 x 2-1/2"

ROLL PINS

METRIC

RP020012	100 / pack	2 x 12mm
RP020020	100	2 x 20mm
RP020025	100	2 x 25mm
RP025012	100	2.5 x 12mm
RP025016	100	2.5 x 16mm
RP025020	100	2.5 x 20mm
RP025025	100	2.5 x 25mm
RP030016	100	3 x 16mm
RP030020	100	3 x 20mm
RP030025	100	3 x 25mm
RP040016	100	4 x 16mm
RP040020	100	4 x 20mm
RP040025	100	4 x 25mm
RP050020	100	5 x 20mm
RP050025	100	5 x 25mm
RP050030	100	5 x 30mm
RP050040	100	5 x 40mm
RP060020	100	6 x 20mm
RP060025	100	6 x 25mm
RP060030	100	6 x 30mm
RP060040	100	6 x 40mm
RP060050	50	6 x 50mm
RP060060	50	6 x 60mm
RP080030	50	8 x 30mm
RP080040	50	8 x 40mm
RP080050	50	8 x 50mm
RP080060	50	8 x 60mm
RP010040	50	10 x 40mm
RP010050	50	10 x 50mm
RP010060	50	10 x 60mm

ROOFING BOLTS & NUTS

ZINC PLATED

CRB1	100 / pack	3/16 x 1/2"
CRB2	100	3/16 x 3/4"
CRB3	100	3/16 x 1"
CRB4	50	3/16 x 1-1/2"
CRB5	50	1/4 x 3/4"
CRB6	50	1/4 x 1"
CRB7	50	1/4 x 1-1/4"
CRB8	50	1/4 x 1-1/2"

SELF-DRILLING SCREWS

SDS1	100 / pack	8G x 12mm Mush Hd.
SDS2	100	8G x 16mm Mush Hd.
SDS3	100	8G x 20mm Mush Hd.
SDS4	100	8G x 25mm Mush Hd.
SDS5	100	10G x 16mm Wafer Hd.
SDS6	100	10G x 22mm Wafer Hd.
SDS7	100	10G x 30mm Wafer Hd.
SDS8	100	10G x 16mm Hex Hd.

SELF-TAPPING SCREWS

HEX HEAD, ZINC PLATED

CST59	100 / pack	6G x 1/2"
CST60	100	6G x 3/4"
CST61	100	6G x 1"
CST62	100	8G x 1/2"
CST63	100	8G x 3/4"
CST64	100	8G x 1"
CST50	100	10G x 3/8"
CST51	100	10G x 1/2"
CST52	100	10G x 3/4"
CST53	100	10G x 1"
CST54	100	12G x 3/4"
CST55	100	12G x 1"
CST56	100	14G x 5/8"
CST57	100	14G x 3/4"
CST58	100	14G x 1"

SELF-TAPPING SCREWS

MUSHROOM HEAD PHILLIPS, BLACK ZINC

CST301	100 / pack	6G x 3/8"
CST302	100	6G x 1/2"
CST303	100	6G x 3/4"
CST304	100	8G x 3/8"
CST305	100	8G x 1/2"
CST306	100	8G x 3/4"
CST307	100	8G x 1"
CST308	100	8G x 1-1/2"
CST309	100	10G x 1/2"
CST310	100	10G x 3/4"
CST311	100	10G x 1"
CST312	100	10G x 1-1/2"
CST313	100	10G x 2"
CST314	100	12G x 1"
CST315	100	12G x 3/4"

SELF-TAPPING SCREWS

PAN HEAD PHILLIPS, NICKEL PLATED

CST93	100 / pack	4G x 1/4"
CST90	100	6G x 3/8"
CST101	100	6G x 1/2"
CST102	100	6G x 3/4"
CST104	100	6G x 1"
CST94	100	8G x 3/8"
CST91	100	8G x 1/2"
CST105	100	8G x 3/4"
CST95	100	8G x 1"
CST103	100	8G x 1-1/2"
CST92	100	10G x 1/2"
CST96	100	10G x 3/4"
CST97	100	10G x 7/8"
CST106	100	10G x 1"
CST107	100	12G x 1"
CST98	100	14G x 1/2"
CST99	100	14G x 5/8"
CST100	100	14G x 3/4"
CST29	100	14G x 1"



SELF-TAPPING SCREWS

RAISED HEAD PHILLIPS, BLACK ZINC

CST203	100 / pack	6G x 1"
CST204	100	8G x 3/4"



SELF-TAPPING SCREWS

RAISED HEAD PHILLIPS, NICKEL PLATED

CST71	100 / pack	4G x 5/8"
CST72	100	6G x 1/2"
CST73	100	6G x 3/4"
CST74	100	6G x 1"
CST75	100	8G x 3/8"
CST76	100	8G x 1/2"
CST81	100	8G x 3/4"
CST77	100	8G x 1"
CST78	100	8G x 1-1/4"
CST79	100	8G x 1-1/2"
CST80	100	10G x 3/4"
CST83	100	10G x 1"
CST82	100	14G x 5/8"



SELF-TAPPING SCREWS

RAISED HEAD SLOTTED, ZINC PLATED

CST30	100 / pack	6G x 3/4"
CST31	100	6G x 1"
CST32	100	8G x 3/4"
CST33	100	8G x 1"



SHIMS – FRONT ALIGNMENT

METRIC, ZINC PLATED

		TYPE	
FAS13	25 / pack	1	10 x 1mm
FAS14	25	1	10 x 2mm
FAS15	25	1	10 x 3mm
FAS16	25	1	12 x 1mm
FAS17	25	1	12 x 2mm
FAS18	25	1	12 x 3mm
FAS19	25	1	14 x 1mm
FAS20	25	1	14 x 2mm
FAS21	25	1	14 x 3mm
FAS22	25	2	10 x 1.5mm
FAS23	25	2	10 x 3mm
FAS24	25	3	10 x 1.5mm
FAS25	25	3	10 x 3mm



TYPE 1



TYPE 2

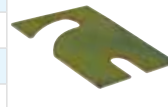

TYPE 3

SOCKET HEAD CAP SCREWS

BSW, HIGH TENSILE

CSC1	50 / pack	1/4 x 1/2"
CSC2	50	1/4 x 3/4"
CSC3	50	1/4 x 1"
CSC4	50	1/4 x 1-1/4"
CSC5	50	1/4 x 1-1/2"
CSC6	50	5/16 x 1/2"
CSC7	50	5/16 x 3/4"
CSC8	50	5/16 x 1"
CSC9	50	5/16 x 1-1/4"
CSC10	50	5/16 x 1-1/2"



SPEED NUTS

CAPTIVE NUTS 'U' TYPE

		LENGTH	WIDTH	SUITS
SNU1219	100 / pack	21/32"	x 7/16"	x 6G
SNU1675	100	13/32"	x 11/32"	x 8G
SNU0536	100	21/32"	x 7/16"	x 8G
SNU1561	100	31/32"	x 7/16"	x 8G
SNU0537	100	13/16"	x 1/2"	x 10G
SNU1670	100	1/2"	x 1/16"	x 10G
NNU8899	100	15/32"	x 11/16"	x 10G



SPEED NUTS

FLAT

		LENGTH	WIDTH	SUITS
SNP0177	100 / pack	21/32"	x 13/32"	x 10G
SNP0170	100	5/8"	x 3/8"	x 3/16"



SPEED NUTS

SPEED PUSH-ON FIXES

		LENGTH	WIDTH	SUITS
SFP1722	100 / pack	7/16"	x 1/4"	x 3/32"
SFP0211	100	1/2"	x 5/16"	x 1/8"
SFP0213	100	5/8"	x 3/8"	x 3/16"



SPLIT PINS

ZINC PLATED

CPS10622	200 / pack	1.6 x 22mm
CPS10625	200	1.6 x 25mm
CPS10628	200	1.6 x 28mm
CPS10632	200	1.6 x 32mm
CPS10636	200	1.6 x 36mm
CPS10640	200	1.6 x 40mm
CPS10650	200	1.6 x 50mm
CPS20020	200	2.0 x 20mm
CPS20022	200	2.0 x 22mm
CPS20025	200	2.0 x 25mm
CPS20028	200	2.0 x 28mm
CPS20036	200	2.0 x 36mm
CPS20040	200	2.0 x 40mm
CPS20045	200	2.0 x 45mm
CPS20050	200	2.0 x 50mm
CPS20525	200	2.5 x 25mm
CPS20532	200	2.5 x 32mm
CPS20536	200	2.5 x 36mm
CPS20540	200	2.5 x 40mm
CPS20545	200	2.5 x 45mm
CPS20550	200	2.5 x 50mm
CPS70625	200	7/64 x 25mm
CPS70632	200	7/64 x 32mm
CPS70650	200	7/64 x 50mm
CPS30220	200	3.2 x 20mm
CPS30225	200	3.2 x 25mm
CPS30232	200	3.2 x 32mm
CPS30236	200	3.2 x 36mm
CPS30240	200	3.2 x 40mm
CPS30245	200	3.2 x 45mm
CPS30250	200	3.2 x 50mm
CPS90645	200	9/64 x 45mm
CPS90650	200	9/64 x 50mm
CPS40032	200	4.0 x 32mm
CPS40036	200	4.0 x 36mm
CPS40040	200	4.0 x 40mm
CPS40045	200	4.0 x 45mm
CPS40050	200	4.0 x 50mm
CPS50032	200	5.0 x 32mm
CPS50040	200	5.0 x 40mm
CPS50050	200	5.0 x 50mm
CPS50063	100	5.0 x 63mm
CPS50075	50	5.0 x 75mm
CPS50100	50	5.0 x 100mm
CPS60050	50	6.0 x 50mm
CPS60100	25	6.0 x 100mm
CPS60340	50	6.3 x 40mm
CPS60345	50	6.3 x 45mm
CPS60350	50	6.3 x 50mm
CPS60363	25	6.3 x 63mm
CPS60375	25	6.3 x 75mm
CPS60380	25	6.3 x 80mm
CPS63100	25	6.3 x 100mm
CPS63115	25	6.3 x 115mm
CPS63120	25	6.3 x 120mm
CPS80075	25	8.0 x 75mm

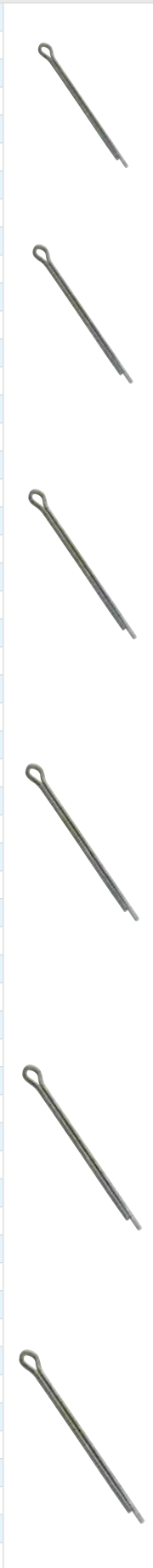

SPLIT PINS *Continued*

ZINC PLATED

CPS80080	25 / pack	8.0 x 80mm
CPS80100	25	8.0 x 100mm
CPS80120	25	8.0 x 120mm
CPS80150	25	8.0 x 150mm
CPS10100	25	10 x 100mm
CPS10112	25	10 x 112mm
CPS10120	25	10 x 120mm
CPS10125	25	10 x 125mm
CPS10150	25	10 x 150mm
CPS10162	25	10 x 162mm
CPS12100	25	12 x 100mm
CPS13125	10	13 x 125mm
CPS13150	10	13 x 150mm
CPS16150	10	16 x 150mm



SPRINGS – ACCELERATOR

LENGTH x OD x WIRE GAUGE

CAS1	10 / pack	6-1/2" x 7/16" x 20G
CAS2	10	6-5/8" x 3/8" x 21G
CAS3	10	6-3/4" x 5/16" x 21G
CAS4	10	6-3/8" x 5/16" x 21G
CAS5	10	5-1/8" x 7/16" x 18G
CAS6	10	5-3/8" x 5/16" x 22G
CAS7	10	4-1/2" x 1/4" x 23G
CAS8	10	6-15/16" x 7/32" x 24G
CAS9	10	5-3/4" x 3/16" x 25G



SPRINGS – COMPRESSION

LENGTH x OD x WIRE GAUGE

CCS25	10 / pack	4" x 3/4" x 14G
CCS26	10	3-3/4" x 5/8" x 16G
CCS27	10	2-3/4" x 5/8" x 17G
CCS28	10	2" x 17/32" x 17G
CCS29	10	2-1/4" x 1/2" x 18G
CCS30	10	2-1/4" x 7/16" x 18G
CCS31	10	3" x 7/16" x 20G
CCS32	10	2-5/8" x 3/8" x 20G
CCS33	10	1-1/4" x 3/8" x 20G
CCS34	10	1-3/4" x 5/16" x 22G
CCS35	10	3" x 5/16" x 24G
CCS36	10	1-1/2" x 3/16" x 26G



SPRINGS – EXTENSION

LENGTH x OD x WIRE GAUGE

CES25	10 / pack	4-3/4" x 1/2" x 15G
CES26	10	4" x 9/16" x 16G
CES27	10	3-3/4" x 1/2" x 17G
CES28	10	2-1/2" x 1/2" x 17G
CES29	10	3" x 7/16" x 18G
CES30	10	2-1/2" x 11/32" x 20G
CES31	10	3-1/8" x 11/32" x 20G
CES32	10	2-7/8" x 9/32" x 21G
CES33	10	2" x 9/32" x 21G
CES34	10	2" x 7/32" x 24G
CES35	10	1" x 7/32" x 24G
CES36	10	1-1/2" x 3/16" x 26G



TAPER PINS		
B-TP016	1 / pack	No.0 x 1"
B-TP024	1	No.0 x 1-1/2"
B-TP116	1	No.1 x 1"
B-TP124	1	No.1 x 1-1/2"
B-TP216	1	No.2 x 1"
B-TP220	1	No.2 x 1-1/4"
B-TP224	1	No.2 x 1-1/2"
B-TP232	1	No.2 x 2"
B-TP312	1	No.3 x 3/4"
B-TP324	1	No.3 x 1-1/2"
B-TP332	1	No.3 x 2"
B-TP424	1	No.4 x 1-1/2"
B-TP432	1	No.4 x 2"
B-TP440	1	No.4 x 2-1/2"
B-TP532	1	No.5 x 2"
B-TP548	1	No.5 x 3"
B-TP632	1	No.6 x 2"
B-TP640	1	No.6 x 2-1/2"
B-TP648	1	No.6 x 3"
B-TP736	1	No.7 x 2-1/4"
B-TP748	1	No.7 x 3"
B-TP848	1	No.8 x 3"
B-TP864	1	No.8 x 4"
B-TP896	1	No.8 x 6"
B-TP964	1	No.9 x 4"
B-TP996	1	No.9 x 6"
B-TP1064	1	No.10 x 4"
B-TP1096	1	No.10 x 6"



Refer to p222 for how to measure Taper Pins

WASHERS		
ALUMINIUM		
1C171	50 / pack	12 x 22 x 2.5mm
1C172	50	14 x 24 x 2.5mm
1C173	50	16 x 24 x 2.5mm
1C174	50	18 x 28 x 2.5mm
1C175	50	20 x 30 x 2.5mm
1C176	50	22 x 32 x 2.5mm
1C177	50	24 x 34 x 2.5mm
1C178	50	1/2 x 7/8 x 2.5mm



WASHERS		
ALUMINIUM, DRAIN (SUMP) PLUG		
CAW1218	50 / pack	12 x 18 x 1.5mm
CAW1420	50	14 x 20 x 1.5mm
CAW1622	50	16 x 22 x 1.5mm
CAW1824	50	18 x 24 x 1.5mm
CAW2024	50	20 x 24 x 1.5mm
CAW2227	50	22 x 27 x 1.5mm
CAW2229	50	22 x 29 x 1.5mm
CAW2430	50	24 x 30 x 1.8mm



WASHERS		
ALUMINIUM, 1/16" THICK		
CAW1	100 / pack	1/4 x 1/2"
CAW2	100	5/16 x 9/16"
CAW3	100	3/8 x 5/8"
CAW4	100	7/16 x 3/4"
CAW5	100	1/2 x 7/8"
CAW6	50	9/16 x 15/16"
CAW7	50	5/8 x 1"
CAW8	50	3/4 x 1-1/8"
CAW9	25	7/8 x 1-1/4"
CAW10	25	1 x 1-3/8"
CAW11	100	5mm x 10mm
CAW12	100	6mm x 12mm
CAW13	100	10mm x 20mm
CAW14	100	12mm x 22mm
CAW15	50	20mm x 30mm



WASHERS		
BONDED (DOWTY), METRIC		
CDW1	25 / pack	Suits 1/8" BSP
CDW2	25	Suits 1/4" BSP
CDW3	25	Suits 3/8" BSP
CDW4	25	Suits 1/2" BSP
CDW5	25	Suits 5/8" BSP
CDW6	25	Suits 3/4" BSP
CDW7	25	Suits 1" BSP
CDW8	25	Suits 1-1/4" BSP
CDW9	25	Suits 8mm
CDW10	25	Suits 10mm
CDW11	25	Suits 12mm
CDW12	25	Suits 14mm
CDW13	25	Suits 16mm
CDW14	25	Suits 18mm
CDW15	25	Suits 20mm
CDW16	25	Suits 22mm
CDW17	25	Suits 26mm
CDW18	25	Suits 27mm
CDW19	25	Suits 28mm
CDW20	25	Suits 30mm
CDW21	25	Suits 33mm
CDW22	25	Suits 42mm



WASHERS		
CUP TYPE, NICKEL PLATED		
CCW1	100 / pack	6G
CCW2	100	8G
CCW3	100	10G



WASHERS

COPPER, IMPERIAL, 20G		
CWC1	100 / pack	1/4 x 9/16"
CWC2	100	5/16 x 5/8"
CWC3	100	3/8 x 3/4"
CWC4	100	7/16 x 13/16"
CWC5	100	1/2 x 7/8"
CWC6	100	9/16 x 15/16"
CWC7	100	5/8 x 1"
CWC8	50	11/16 x 1-1/16"
CWC9	50	3/4 x 1-1/8"
CWC10	50	13/16 x 1-3/16"
CWC11	50	7/8 x 1-3/8"
CWC12	50	1 x 1-1/2"



WASHERS

COPPER, METRIC, 1mm THICK		
CWC31	100 / pack	5 x 10mm
CWC32	100	6 x 12.5mm
CWC33	100	8 x 16mm
CWC34	100	10 x 20mm
CWC35	100	12 x 22mm
CWC36	100	14 x 24mm
CWC37	100	16 x 25mm
CWC38	50	20 x 30mm
CWC39	50	22 x 35mm
CWC40	50	24 x 38mm



WASHERS

COPPER RING		
CWC41	100 / pack	6 x 10 x 1mm
CWC42	100	8 x 12 x 1mm
CWC43	100	8 x 14 x 1mm
CWC44	100	10 x 14 x 1mm
CWC45	100	10 x 16 x 1mm
CWC46	100	12 x 16 x 1.5mm
CWC47	100	12 x 18 x 1.5mm
CWC48	100	14 x 18 x 1.5mm
CWC49	100	14 x 20 x 1.5mm
CWC50	50	16 x 20 x 1.5mm
CWC51	50	16 x 22 x 1.5mm
CWC52	50	18 x 24 x 1.5mm
CWC53	50	20 x 26 x 1.5mm
CWC54	50	26 x 31 x 2mm



WASHERS

DRAIN (SUMP) PLUG, BLACK FIBRE		
CFW31	25 / pack	12 x 24 x 2.00mm
CFW32	25	18 x 28 x 2.00mm



WASHERS

DRAIN (SUMP) PLUG, WHITE FIBRE		
CFW1224	25 / pack	12 x 24 x 2.00mm
CFW1622	25	16 x 22 x 2.00mm
CFW1828	25	18 x 28 x 2.00mm
CFW2535	25	25 x 35 x 2.00mm



WASHERS

FIBRE, 1/32" THICK		
CFW1321	100 / pack	1/8 x 5/16"
CFW1322	100	5/32 x 3/8"
CFW1323	100	3/16 x 1/2"
CFW1324	100	7/32 x 1/2"
CFW1325	100	1/4 x 9/16"
CFW1327	100	5/16 x 5/8"
CFW1328	100	3/8 x 3/4"
CFW1329	100	7/16 x 13/16"
CFW13210	100	1/2 x 7/8"
CFW13211	100	9/16 x 15/16"
CFW13212	100	5/8 x 1"
CFW13213	100	11/16 x 1-1/16"
CFW13214	100	3/4 x 1-1/8"
CFW13215	100	13/16 x 1-3/16"
CFW13216	100	7/8 x 1-3/8"
CFW13218	100	1 x 1-1/2"



WASHERS

FIBRE, 1/16" THICK		
CFW161	100 / pack	5/32 x 5/16"
CFW162	100	3/16 x 3/8"
CFW163	100	7/32 x 7/16"
CFW164	100	1/4 x 7/16"
CFW165	100	5/16 x 1/2"
CFW166	100	3/8 x 5/8"
CFW167	100	7/16 x 11/16"
CFW168	100	1/2 x 3/4"
CFW169	100	9/16 x 13/16"
CFW1610	100	5/8 x 7/8"
CFW1611	100	11/16 x 15/16"
CFW1612	100	3/4 x 1"



WASHERS

FIBRE, DRAIN (SUMP) PLUG, 3/32" THICK		
CFW3321	50 / pack	1/2 x 3/4" (No.1 Plug)
CFW3328	50	5/8 x 7/8" (No.3 Plug)
CFW3323	50	3/4 x 1-1/8"
CFW3324	50	13/16 x 1-3/16"
CFW3325	25	7/8 x 1-1/4"
CFW3326	25	1 x 1-3/8"
CFW3329	25	For No.1 O/S Plug
CFW14	25	14 x 20mm
CFW18	25	18 x 27mm
CFW30	25	30 x 38mm



WASHERS

FLAT STEEL, IMPERIAL, ZINC PLATED		
CWS1	200 / pack	1/8 x 3/8" x 20G
CWS2	200	5/32 x 7/16" x 20G
CWS3	200	3/16 x 7/16" x 20G
CWS4	200	1/4 x 9/16" x 18G
CWS5	200	5/16 x 5/8" x 18G
CWS6	200	3/8 x 3/4" x 16G
CWS7	200	7/16 x 7/8" x 16G
CWS8	200	1/2 x 1" x 16G
CWS9	200	9/16 x 1-1/8" x 16G
CWS10	200	5/8 x 1-1/4" x 15G
CWS11	100	3/4 x 1-1/2" x 14G
CWS12	100	7/8 x 1-5/8" x 14G
CWS13	100	1 x 1-7/8" x 14G



BULK PACKS

WASHERS

FLAT STEEL, METRIC, ZINC PLATED

CWS29	200 / pack	M5 x 10 x 1mm
CWS30	200	M6 x 12.5 x 1.2mm
CWS31	200	M8 x 17 x 1.2mm
CWS32	200	M10 x 21 x 1.6mm
CWS33	200	M12 x 24 x 1.6mm
CWS34	200	M20 x 37 x 2.0mm
CWS35	200	M24 x 44 x 2.0mm



WASHERS

FLAT STEEL, HEAVY DUTY, ZINC PLATED

CHW1	200 / pack	3/16 x 1/2" x 18G
CHW2	200	1/4 x 9/16" x 14G
CHW3	200	5/16 x 5/8" x 14G
CHW4	150	3/8 x 3/4" x 14G
CHW5	150	7/16 x 7/8" x 14G
CHW6	100	1/2 x 1" x 14G
CHW7	100	5/8 x 1-3/8" x 14G
CHW8	100	3/4 x 1-1/2" x 14G



WASHERS

FLAT STEEL, SUPER HEAVY DUTY, ZINC PLATED

CHW21	100 / pack	3/16 x 9/16" x 16G
CHW22	100	1/4 x 3/4" x 16G
CHW23	100	5/16 x 7/8" x 14G
CHW24	100	3/8 x 7/8" x 10G
CHW25	50	7/16 x 1" x 10G
CHW26	50	1/2 x 1-1/4" x 10G
CHW27	25	5/8 x 1-3/4" x 9G
CHW28	25	3/4 x 2" x 9G



WASHERS

FLAT STEEL, HIGH TENSILE, ZINC PLATED

CHW30	100 / pack	1/4 x 5/8" x 16G
CHW31	100	5/16 x 11/16" x 16G
CHW32	100	3/8 x 13/16" x 16GS
CHW33	100	7/16 x 59/64" x 16G
CHW34	50	1/2 x 1-1/16" x 11G
CHW35	50	9/16 x 1-3/16" x 11G
CHW36	50	5/8 x 1-5/16" x 10G
CHW37	50	3/4 x 1-15/32" x 10G
CHW38	25	7/8 x 1-3/4" x 9G
CHW39	25	1 x 2" x 9G



WASHERS

FLAT STEEL, PANEL (BODY), ZINC PLATED

CBW1	50 / pack	3/16 x 1"
CBW2	50	1/4 x 1-1/4"
CBW3	50	5/16 x 1-1/4"
CBW4	50	3/8 x 1-1/4"
CBW5	25	1/2 x 1-1/2"
CBW6	10	5/8 x 2"



WASHERS

NYLON, 1/32" THICK

CNW1	50 / pack	12 x 22mm
CNW2	50	14 x 22mm
CNW3	50	16 x 24mm
CNW4	50	18 x 28mm
CNW5	25	25 x 35mm
CNW6	50	1/2 x 3/4"
CNW7	50	0.530 x 3/4"
CNW8	50	5/8 x 15/16"
CNW9	50	11/16 x 1"
CNW10	50	3/4 x 1-1/8"
CNW11	50	13/16 x 1-3/16"



WASHERS

STEEL SPACING, 22G THICK (.028")

SPW2	100 / pack	1/4 x 9/16"
SPW3	100	5/16 x 11/16"
SPW4	100	3/8 x 3/4"
SPW5	100	7/16 x 13/16"
SPW6	100	1/2 x 7/8"
SPW7	100	9/16 x 15/16"
SPW8	100	5/8 x 1"
SPW9	100	11/16 x 1-1/16"
SPW11	100	3/4 x 1-1/8"
SPW12	100	13/16 x 1-3/16"
SPW13	100	7/8 x 1-1/4"
SPW14	100	15/16 x 1-3/8"
SPW15	100	1 x 1-1/2"
SPW17	50	1-1/8 x 1-3/4"
SPW19	50	1-1/4 x 2"
SPW21	50	1-1/2 x 2-1/4"



WASHERS

SPRING, FLAT SECTION, IMPERIAL & METRIC, ZINC PLATED

WIS532	200 / pack	5/32"
WIS3	200	3/16"
WIS4	200	1/4"
WIS5	200	5/16"
WIS6	150	3/8"
WIS7	150	7/16"
WIS8	100	1/2"
WIS9	50	9/16"
WIS10	50	5/8"
WIS12	25	3/4"
WMS5	200	5mm
WMS6	200	6mm
WMS10	150	10mm
WMS12	100	12mm
WMS20	25	20mm



WIRING TERMINALS

13-5	100 / pack	3/16" Red Ring
13-6	100	1/4" Red Ring
22-5	100	3/16" Blue Ring
22Y-4	100	5/32" Blue Spade
23-8	100	5/16" Blue Ring
53-8	100	5/16" Yellow Ring
53-10	100	3/8" Yellow Ring
153V	100	Male Push-On 2 Way Conn.
200F	100	Red Female Bullet
200M	100	Red Male Bullet
201F	100	Blue Female Bullet
201M	100	Blue Male Bullet
309F	100	Red Female Push-On
309WF	100	Red Female Fully Insulated
309M	100	Red Male Push-On
320F	100	Blue Female Push-On
320WF	100	Blue Female Fully Insulated
320M	100	Blue Male Push-On
355F	100	Yellow Female Push-On
355WF	100	Yellow Female Fully Insul.
355M	100	Yellow Male Push-On
KSB100	100	Blue Wire Tap
KSR100	100	Red Wire Tap
QCF	100	Female Lanced Push-On
QCM	100	Male Lanced Push-On
TG1	100	Red Cable Connector
TG2	100	Blue Cable Connector
TG3	100	Yellow Cable Connector



WOODRUFF KEYS

IMPERIAL

CWK1	25 / pack	1/2 x 1/16"
CWK2	25	1/2 x 3/32"
CWK3	25	1/2 x 1/8"
CWK4	25	5/8 x 3/32"
CWK5	25	5/8 x 1/8"
CWK6	25	5/8 x 5/32"
CWK61	25	5/8 x 3/16"
CWK7	25	3/4 x 1/8"
CWK8	25	3/4 x 5/32"
CWK9	25	3/4 x 3/16"
CWK91	25	3/4 x 1/4"
CWK10	25	7/8 x 5/32"
CWK11	25	7/8 x 3/16"
CWKA	25	7/8 x 1/4"
CWK13	25	1 x 3/16"
CWK15	25	1 x 1/4"
CWKB	25	1 x 5/16"
CWK16	25	1-1/8 x 3/16"
CWK18	25	1-1/8 x 1/4"
CWKC	25	1-1/8 x 5/16"
CWK21	25	1-1/4 x 1/4"
CWKD	25	1-1/4 x 5/16"
CWKE	25	1-1/4 x 3/8"



WOODRUFF KEYS

METRIC

MWK3	25 / pack	2 x 10mm
MWK5	25	2.5 x 10mm
MWK6	25	3 x 10mm
MWK7	25	3 x 13mm

WOODRUFF KEYS *Continued*

METRIC

MWK8	25 / pk	3 x 16mm
MWK9	25	3 x 19mm
MWK10	25	4 x 13mm
MWK11	25	4 x 16mm
MWK12	25	4 x 19mm
MWK14	25	5 x 16mm
MWK15	25	5 x 19mm
MWK16	25	5 x 22mm
MWK19	25	6 x 22mm
MWK21	25	6 x 28mm
MWK26	25	8 x 28mm
MWK27	25	8 x 32mm
MWK30	25	10 x 32mm



VACUUM HOSE CONNECTORS

NHC1	25 / pk	T Piece 3mm
NHC2	25	T Piece 5mm
NHC3	25	T Piece 6mm
NHC4	25	T Piece 8mm
NHC5	25	T Piece 10mm
NHC6	25	90° Elbow 3mm
NHC7	25	90° Elbow 5mm
NHC8	25	90° Elbow 6mm
NHC9	25	90° Elbow 8mm
NHC10	25	90° Elbow 10mm
NHC11	25	Reducing T Piece 3 - 4 - 3mm
NHC12	25	Reducing T Piece 4 - 6 - 4mm
NHC13	25	Reducing T Piece 6 - 4 - 6mm
NHC14	25	Reducing T Piece 8 - 4 - 8mm
NHC15	25	Reducing T Piece 8 - 6 - 8mm
NHC16	25	Reducing T Piece 10-6-10mm
NHC17	25	Straight Connector 3mm
NHC18	25	Straight Connector 5mm
NHC19	25	Straight Connector 6mm
NHC20	25	Straight Connector 8mm
NHC21	25	Straight Connector 10mm
NHC22	25	Reducing Str Conn 4 - 3mm
NHC23	25	Reducing Str Conn 6 - 4mm
NHC24	25	Reducing Str Conn 8 - 6mm
NHC25	25	Reducing Str Conn 10 - 6mm
NHC26	25	Reducing Str Conn 10 - 8mm
NHC27	25	4 Way X Piece 5mm
NHC28	25	4 Way X Piece 6mm
NHC29	25	3 Way Y Piece 3mm
NHC30	25	3 Way Y Piece 5mm
NHC31	25	3 Way Y Piece 6mm
NHC32	25	3 Way Y Piece 8mm
NHC33	25	3 Way Y Piece 10mm
NHC34	25	Reducing Y Piece 6-8-6mm
NHC35	25	Tailpiece 4mm 1/4" BSP
NHC36	25	Tailpiece 5mm 1/4" BSP
NHC37	25	Tailpiece 6mm 1/4" BSP
NHC38	25	Tailpiece 8mm 1/4" BSP
NHC39	25	Elbow 6mm x 1/4" BSP
NHC40	25	Elbow 8mm x 1/4" BSP
NHC41	25	Hex Taper Plug 1/8" BSP
NHC42	25	Hex Taper Plug 1/4" BSP
NHC43	25	Hex Taper Plug 3/8" BSP
NHC44	25	3mm Vacuum Cap
NHC45	25	4mm Vacuum Cap
NHC46	25	5mm Vacuum Cap
NHC47	25	6mm Vacuum Cap
NHC48	25	8mm Vacuum Cap
NHC49	25	10mm Vacuum Cap



BULK PACKS

STAINLESS STEEL HOSE CLAMPS

Premium quality clamps to provide positive, reliable connections and sealing.



'RY' Series

'SS' Series

MICRO CLAMPS 8mm Band

Tiny. Tough. Precision Engineered.

Easy to install in confined areas. Narrow housing, low profile means no wings and no protrusions. Boasts one of the highest screw torques in the field with slotted 1/4" hex head screw. Maintains highest sealing pressures with only 10 inch-pounds of applied screw torque.

'RY' STANDARD SERIES 12.8mm Band

Nickel bearing stainless steel band and housing.
Zinc plated, carbon steel screw.

'SS' STAINLESS SERIES

Band and housing of SAE Standard 300 Marine Grade Stainless Steel. Slotted 5/16" hex head screw is SAE Standard 305 Stainless. The extra high nickel alloy stainless steel meets extreme demands of corrosive and underwater environments.

Always check the band is securely tightened.

Features:

- Band and housing to SAE Standard 300 Stainless Steel
- One piece stainless steel housing with interlocked construction
- Combined screwdriver slot and hex head screw design allow use of screwdriver, socket or spintite.

PART No.	'RY' MICRO SERIES 8mm Band	
	Min. Hose I.D.	Max. Hose I.D.
RY4	6mm	16mm
RY6	8mm	22mm
RY7	11mm	25mm

PART No.	'RY' STANDARD SERIES 12.8mm Band	
	Min. Hose I.D.	Max. Hose I.D.
RY06WB	10mm	12mm
RY08	11mm	25mm
RY10	13mm	28mm
RY12	13mm	32mm
RY16	19mm	40mm
RY20	19mm	44mm
RY24	26mm	50mm
RY28	34mm	57mm
RY32	40mm	64mm
RY36	40mm	70mm
RY40	40mm	76mm
RY44	45mm	82mm
RY48	45mm	90mm
RY52	48mm	95mm
RY56	54mm	100mm
RY64	67mm	114mm
RY72	80mm	130mm
RY80	92mm	140mm
RY88	108mm	150mm
RY96	121mm	165mm
RY104	102mm	178mm

PART No.	MICRO SS STAINLESS STEEL SERIES 8mm Band	
	Min. Hose I.D.	Max. Hose I.D.
SS4	6mm	16mm
SS6	8mm	22mm

PART No.	SS STAINLESS STEEL SERIES 12.8mm Band	
	Min. Hose I.D.	Max. Hose I.D.
SS06WB	10mm	12mm
SS08	11mm	25mm
SS10	13mm	28mm
SS12	13mm	32mm
SS16	19mm	40mm
SS20	19mm	44mm
SS24	26mm	50mm
SS28	34mm	57mm
SS32	40mm	64mm
SS36	40mm	70mm
SS40	40mm	76mm
SS44	45mm	82mm
SS48	45mm	90mm
SS52	48mm	95mm
SS56	54mm	100mm
SS64	67mm	114mm
SS72	80mm	130mm
SS80	92mm	140mm
SS88	108mm	150mm
SS96	121mm	165mm
SS104	102mm	178mm

STAINLESS STEEL HOSE CLAMP ASSORTMENT *with Carry Case*

Stainless Steel band and saddle. Zinc plated screw.



CHCA120 STAINLESS STEEL HOSE CLAMP ASSORT.

- Stainless Steel band and saddle
- Zinc Plated screw
- 9 Sizes: 6mm-16mm to 40mm-64mm
- 120 Pieces

'RY' Micro and Standard Series

ASSORTMENT CONTENTS:

'RY' Standard Series, 8mm Band

		Min Hose I.D.	Max Hose I.D.
RY4	20 qty	6mm	16mm
RY6	20	8mm	22mm
RY08	20	11mm	25mm
RY10	10	13mm	28mm
RY12	10	13mm	22mm
RY20	10	19mm	44mm
RY24	10	26mm	50mm
RY28	10	34mm	57mm
RY32	10	40mm	64mm

BULK PACKS

HOSE CLAMP DRIVERS



HCD1 7mm HOSE CLAMP DRIVER

- 7mm fitting suits worm drive hose clips
- Comfortable grip handle
- Flexible steel spiral shaft
- Overall length: 270mm



*Reversible,
Two Component Handle*

HCD2 6mm/7mm HOSE CLAMP DRIVER

- Reversible 6mm or 7mm fitting to suit most worm drive hose clips
- Two component handle
- Comfortable grip handle
- Flexible plastic covered steel spiral shaft for easier access
- Overall length: 280mm



METRIC SERIES ISO GR8.8 HIGH TENSILE. HEX BOLTS, SET SCREWS & NUTS

METRIC THREADS ISO

M4 x 0.7

M1	25 / pack	10mm Set Screws & Nuts
M2	25	12mm Set Screws & Nuts
M3	25	16mm Set Screws & Nuts
M4	25	20mm Set Screws & Nuts
M5	25	25mm Set Screws & Nuts
M6	25	30mm Set Screws & Nuts
M7	25	35mm Set Screws & Nuts
M8	25	40mm Set Screws & Nuts
M9	25	50mm Set Screws & Nuts

METRIC THREADS ISO

M5 x 0.8

M10	25 / pack	10mm Set Screws & Nuts
M11	25	12mm Set Screws & Nuts
M12	25	16mm Set Screws & Nuts
M13	25	20mm Set Screws & Nuts
M14	25	25mm Set Screws & Nuts
M15	25	30mm Set Screws & Nuts
M16	25	35mm Set Screws & Nuts
M17	25	40mm Set Screws & Nuts
M18	25	50mm Set Screws & Nuts

METRIC THREADS ISO

M6 x 1.00

M19	25 / pack	10mm Set Screws
M20	25	12mm Set Screws
M21	25	16mm Set Screws
M22	25	20mm Set Screws
M23	25	25mm Set Screws
M25	30	30mm Set Screws
M26	25	35mm Set Screws
M27	25	40mm Set Screws
M29	25	50mm Bolts & Nuts
M30	25	50mm Set Screws
M31	25	60mm Set Screws
M32	25	60mm Bolts & Nuts
M33	25	65mm Bolts & Nuts
M34	25	70mm Bolts & Nuts
M35	25	80mm Bolts & Nuts
M36	25	90mm Bolts & Nuts
M37	25	100mm Bolts & Nuts

METRIC THREADS ISO

M7 x 1.00

M39	25 / pack	25mm Set Screws
M40	25	35mm Set Screws
M41	25	40mm Set Screws
M42	25	50mm Set Screws
M43	25	60mm Bolts & Nuts

METRIC THREADS ISO

M8 x 1.25

M44	25 / pack	12mm Set Screws
M45	25	16mm Set Screws
M46	25	18mm Set Screws
M47	25	20mm Set Screws
M48	25	25mm Set Screws
M51	25	30mm Set Screws
M52	25	35mm Set Screws
M53	25	35mm Bolts & Nuts
M54	25	40mm Bolts & Nuts
M55	25	40mm Set Screws
M56	25	45mm Bolts & Nuts
M57	25	50mm Bolts & Nuts
M58	25	50mm Set Screws
M59	25	55mm Bolts & Nuts
M60	25	60mm Bolts & Nuts
M61	25	60mm Set Screws
M62	25	65mm Set Screws
M63	25	65mm Bolts & Nuts
M64	25	70mm Bolts & Nuts
M65	25	75mm Bolts & Nuts
M66	25	75mm Set Screws
M67	25	80mm Bolts & Nuts
M68	25	90mm Bolts & Nuts
M69	20	100mm Bolts & Nuts
M70	20	100mm Set Screws

FINE PITCH METRIC THREADS

M8 x 1.00

M71	25 / pack	20mm Set Screws
M72	25	25mm Set Screws
M73	25	30mm Set Screws
M74	25	35mm Set Screws
M75	25	40mm Set Screws
M76	25	50mm Set Screws
M77	25	60mm Bolts & Nuts

METRIC THREADS ISO

M10 x 1.5

M78	25 / pack	20mm Set Screws
M79	25	25mm Set Screws
M81	25	30mm Bolts & Nuts
M82	25	35mm Bolts & Nuts
M83	25	35mm Set Screws
M84	25	40mm Set Screws
M85	25	40mm Bolts & Nuts
M86	25	45mm Bolts & Nuts
M87	25	50mm Bolts & Nuts
M88	25	50mm Set Screws
M89	25	60mm Bolts & Nuts

METRIC THREADS ISO <i>Continued</i>		
M10 x 1.5		
M90	20 / pack	60mm Set Screws
M91	20	65mm Bolts & Nuts
M92	20	65mm Set Screws
M93	20	70mm Bolts & Nuts
M94	20	75mm Bolts & Nuts
M95	20	75mm Set Screws
M96	20	80mm Bolts & Nuts
M97	15	90mm Bolts & Nuts
M98	15	100mm Bolts & Nuts
M99	10	100mm Set Screws
FINE PITCH METRIC THREAD		
M10 x 1.00		
M100	25 / pack	20mm Set Screws
M101	25	25mm Set Screws
M102	25	35mm Set Screws
FINE PITCH METRIC THREAD		
M10 x 1.25		
M103	25 / pack	20mm Set Screws
M104	25	25mm Set Screws
M105	25	30mm Set Screws
M106	25	35mm Set Screws
M107	25	40mm Set Screws
M109	25	45mm Bolts & Nuts
M110	25	50mm Set Screws
M111	15	60mm Bolts & Nuts
M112	15	70mm Bolts & Nuts
METRIC THREAD ISO		
M12 x 1.75		
M113	25 / pack	20mm Set Screws
M114	25	25mm Set Screws
M116	25	30mm Set Screws
M119	25	35mm Set Screws
M120	25	40mm Set Screws
M121	25	40mm Bolts & Nuts
M122	25	45mm Bolts & Nuts
M123	25	45mm Set Screws
M124	20	50mm Set Screws
M125	20	50mm Bolts & Nuts
M126	15	60mm Bolts & Nuts
M127	15	60mm Set Screws
M128	15	65mm Bolts & Nuts
M129	15	65mm Set Screws
M130	15	70mm Set Screws
M131	15	70mm Bolts & Nuts
M132	15	75mm Bolts & Nuts
M133	10	80mm Bolts & Nuts
M134	10	90mm Bolts & Nuts
M135	10	100mm Bolts & Nuts
M136	10	100mm Set Screws
FINE PITCH METRIC THREAD		
M12 x 1.5		
M137	25 / pack	20mm Set Screws
M138	20	25mm Set Screws
M139	20	30mm Set Screws
M140	20	35mm Set Screws
M141	20	40mm Set Screws
M142	20	40mm Bolts & Nuts
M143	20	45mm Bolts & Nuts
M144	15	50mm Bolts & Nuts

FINE PITCH METRIC THREAD <i>Continued</i>		
M12 x 1.5		
M145	15 / pack	50mm Set Screws
M147	15	60mm Bolts & Nuts
M148	15	75mm Bolts & Nuts
FINE PITCH METRIC THREAD		
M12 x 1.25		
M149	20 / pack	30mm Set Screws
M150	20	35mm Set Screws
M151	20	45mm Set Screws
M152	15	50mm Set Screws
M153	15	60mm Bolts & Nuts
M154	15	75mm Bolts & Nuts
HEXAGON METRIC THREADS		
NUTS		
M155	50 / pack	M3 x 0.5mm ISO
M156	50	M4 x 0.7mm ISO
M157	50	M5 x 0.8mm ISO
M158	50	M5 x 0.9mm Special
M159	50	M6 x 1.00mm ISO
M160	50	M7 x 1.00mm ISO
M161	50	M8 x 1.25mm ISO
M162	25	M8 x 1.00mm Fine
M163	25	M10 x 1.5mm ISO
M164	25	M10 x 1.25mm JIS
M165	25	M10 x 1.0mm Fine
M166	25	M12 x 1.75mm ISO
M167	25	M12 x 1.5mm Fine
M168	25	M12 x 1.25mm JIS
FLANGE BOLTS & NUTS		
M5 x 0.8		
MFB12	25 / pack	16mm
MFB14	25	25mm
FLANGE BOLTS & NUTS		
M6 x 1.00		
MFB21	25 / pack	16mm
MFB22	25	20mm
MFB23	25	25mm
MFB25	25	30mm
MFB27	25	40mm
FLANGE BOLTS & NUTS		
M8 x 1.25		
MFB45	25 / pack	16mm
MFB47	25	20mm
MFB48	25	25mm
MFB51	25	30mm
MFB55	25	40mm
MFB57	25	50mm
FLANGE BOLTS & NUTS		
M10 x 1.25		
MFB104	25 / pack	25mm
MFB106	25	35mm
MFB107	25	40mm
MFB110	25	50mm
FLANGE NUTS		
MFN157	50 / pack	M5 x 0.8mm
MFN159	50	M6 x 1.00mm
MFN161	50	M8 x 1.25mm
MFN163	50	M10 x 1.50mm
MFN164	50	M10 x 1.25mm



UNF SERIES GR5 HIGH TENSILE. HEX BOLTS, SET SCREWS & NUTS

1/4" UNF THREADS

F1	25 / pack	1/2" Set Screws
F2	25	5/8" Set Screws
F3	25	3/4" Set Screws
F4	25	1" Set Screws
F6	25	1-1/4" Set Screws
F8	25	1-1/2" Set Screws
F9	25	1-1/2" Bolts & Nuts
F10	25	1-3/4" Bolts & Nuts
F11	25	2" Set Screws
F12	25	2" Bolts & Nuts
F13	25	2-1/2" Bolts & Nuts
F14	25	3" Bolts & Nuts

5/16" UNF THREADS

F15	25 / pack	3/4" Set Screws
F16	25	1" Set Screws
F19	25	1-1/4" Set Screws
F20	25	1-1/2" Bolts & Nuts
F21	25	1-1/2" Set Screws
F22	25	1-3/4" Bolts & Nuts
F23	25	2" Bolts & Nuts
F24	25	2" Set Screws
F26	25	2-1/2" Bolts & Nuts
F28	25	3" Bolts & Nuts
F29	25	3-1/2" Bolts & Nuts
F30	25	4" Bolts & Nuts

3/8" UNF THREADS

F31	25 / pack	3/4" Set Screws
F32	25	1" Set Screws
F34	25	1-1/4" Bolts & Nuts
F35	25	1-1/4" Set Screws
F36	25	1-1/2" Set Screws
F37	25	1-1/2" Bolts & Nuts
F38	25	1-3/4" Bolts & Nuts
F39	25	2" Bolts & Nuts
F40	25	2" Set Screws
F42	25	2-1/2" Bolts & Nuts
F43	20	3" Bolts & Nuts
F45	20	3-1/2" Bolts & Nuts
F47	20	4" Bolts & Nuts
F48	10	4-1/2" Bolts & Nuts

7/16" UNF THREADS

F50	25 / pack	1" Set Screws
F53	25	1-1/4" Set Screws
F54	25	1-1/2" Set Screws
F55	25	1-1/2" Bolts & Nuts
F56	20	1-3/4" Bolts & Nuts
F57	20	2" Bolts & Nuts
F58	15	2-1/2" Bolts & Nuts
F59	15	3" Bolts & Nuts
F60	10	3-1/2" Bolts & Nuts
F61	10	4" Bolts & Nuts

1/2" UNF THREADS

F62	25 / pack	1" Set Screws
F63	25	1-1/4" Set Screws
F65	25	1-1/2" Bolts & Nuts
F66	25	1-1/2" Set Screws
F67	25	1-3/4" Set Screws
F68	20	1-3/4" Bolts & Nuts
F69	20	2" Bolts & Nuts
F70	20	2" Set Screws
F72	15	2-1/2" Bolts & Nuts
F74	10	3" Bolts & Nuts
F75	10	3-1/2" Bolts & Nuts
F76	10	4" Bolts & Nuts

NUTS UNF HEXAGON

F77	50 / pack	1/4" Nuts
F78	50	5/16" Nuts
F79	50	3/8" Nuts
F80	25	7/16" Nuts
F81	25	1/2" Nuts

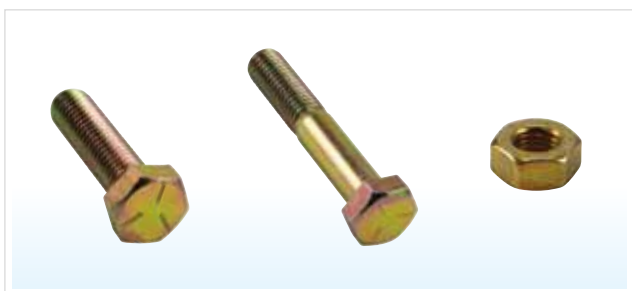



UNC SERIES GR5 HIGH TENSILE. HEX BOLTS, SET SCREWS & NUTS

1/4" UNC THREADS

C1	25 / pack	1/2" Set Screws
C2	25	5/8" Set Screws
C3	25	3/4" Set Screws
C4	25	1" Set Screws
C6	25	1-1/4" Set Screws
C8	25	1-1/2" Set Screws
C9	25	1-1/2" Bolts & Nuts
C10	25	1-3/4" Bolts & Nuts
C11	25	2" Set Screws
C12	25	2" Bolts & Nuts
C13	25	2-1/2" Bolts & Nuts
C14	25	3" Bolts & Nuts

5/16" UNC THREADS

C15	25 / pack	3/4" Set Screws
C16	25	1" Set Screws
C19	25	1-1/4" Set Screws
C20	25	1-1/2" Bolts & Nuts
C21	25	1-1/2" Set Screws
C22	25	1-3/4" Bolts & Nuts
C23	25	2" Bolts & Nuts
C24	25	2" Set Screws
C26	25	2-1/2" Bolts & Nuts
C28	25	3" Bolts & Nuts
C29	25	3-1/2" Bolts & Nuts
C30	25	4" Bolts & Nuts

3/8" UNC THREADS

C31	25 / pack	3/4" Set Screws
C32	25	1" Set Screws
C35	25	1-1/4" Set Screws
C36	25	1-1/2" Set Screws
C37	25	1-1/2" Bolts & Nuts
C38	25	1-3/4" Bolts & Nuts
C39	25	2" Bolts & Nuts
C40	25	2" Set Screws
C42	25	2-1/2" Bolts & Nuts
C43	20	3" Bolts & Nuts
C45	20	3-1/2" Bolts & Nuts
C47	20	4" Bolts & Nuts
C48	10	4-1/2" Bolts & Nuts

7/16" UNC THREADS

C50	25 / pack	1" Set Screws
C53	25	1-1/4" Set Screws
C54	25	1-1/2" Set Screws
C55	25	1-1/2" Bolts & Nuts
C56	20	1-3/4" Bolts & Nuts
C57	20	2" Bolts & Nuts
C58	15	2-1/2" Bolts & Nuts
C59	15	3" Bolts & Nuts
C60	10	3-1/2" Bolts & Nuts
C61	10	4" Bolts & Nuts

1/2" UNC THREADS

C62	25 / pack	1" Set Screws
C63	25	1-1/4" Set Screws
C65	25	1-1/2" Bolts & Nuts
C66	25	1-1/2" Set Screws
C67	25	1-3/4" Set Screws
C68	20	1-3/4" Bolts & Nuts
C69	20	2" Bolts & Nuts
C70	20	2" Set Screws
C71	15	2-1/4" Bolts & Nuts
C72	15	2-1/2" Bolts & Nuts
C74	10	3" Bolts & Nuts
C75	10	3-1/2" Bolts & Nuts
C76	10	4" Bolts & Nuts

NUTS UNC HEXAGON

C77	50 / pack	1/4" Nuts
C78	50	5/16" Nuts
C79	50	3/8" Nuts
C80	25	7/16" Nuts
C81	25	1/2" Nuts



METRIC, HIGH TENSILE, GR8.8 BOLTS & SET SCREWS

GRADE 8.8, HIGH TENSILE, A.S. 1100 – DIN 931 & 933

- FULLY THREADED
- ZINC PLATED



3 x 0.5 ISO			
M93303010	500 qty	3 x 10mm Set Screws	●
M93303016	500	3 x 16mm Set Screws	●
M93303020	500	3 x 20mm Set Screws	●
M93303025	500	3 x 25mm Set Screws	●
M93303030	500	3 x 30mm Set Screws	●
M93303050	500	3 x 50mm Set Screws	●

4 x 0.7 ISO			
M93304010	500 qty	4 x 10mm Set Screws	●
M93304012	500	4 x 12mm Set Screws	●
M93304016	500	4 x 16mm Set Screws	●
M93304020	500	4 x 20mm Set Screws	●
M93304025	500	4 x 25mm Set Screws	●
M93304030	500	4 x 30mm Set Screws	●
M93304035	500	4 x 35mm Set Screws	●
M93304040	500	4 x 40mm Set Screws	●
M93304045	500	4 x 45mm Set Screws	●
M93304050	500	4 x 50mm Set Screws	●

5 x 0.8 ISO			
M93305010	500 qty	5 x 10mm Set Screws	● ●
M93305012	500	5 x 12mm Set Screws	●
M93305016	500	5 x 16mm Set Screws	● ●
M93305020	500	5 x 20mm Set Screws	● ●
M93305025	500	5 x 25mm Set Screws	● ●
M93305030	500	5 x 30mm Set Screws	● ●
M93305035	200	5 x 35mm Set Screws	● ●
M93305040	200	5 x 40mm Set Screws	● ●
M93305045	200	5 x 45mm Set Screws	● ●
M93305050	200	5 x 50mm Set Screws	● ●
M93305060	200	5 x 60mm Set Screws	● ●
M93305065	200	5 x 65mm Set Screws	● ●
M93105065	200	5 x 65mm Bolts Only	

6 x 1.00 ISO			
M933060008	500 qty	6 x 8mm Set Screws	● ●
M933060010	500	6 x 10mm Set Screws	● ●
M933060012	500	6 x 12mm Set Screws	● ●
M933060016	500	6 x 16mm Set Screws	● ●
M933060020	500	6 x 20mm Set Screws	● ●
M933060025	500	6 x 25mm Set Screws	● ●
M933060030	500	6 x 30mm Set Screws	● ●
M933060035	200	6 x 35mm Set Screws	● ●
M933060040	200	6 x 40mm Set Screws	● ●
M931060040	200	6 x 40mm Bolts Only	
M933060045	200	6 x 45mm Set Screws	● ●
M931060045	200	6 x 45mm Bolts Only	
M933060050	200	6 x 50mm Set Screws	● ●
M931060050	200	6 x 50mm Bolts Only	●

6 x 1.00 ISO <i>Continued</i>			
M931060055	200 qty	6 x 55mm Bolts Only	
M933060060	200	6 x 60mm Set Screws	●
M931060060	200	6 x 60mm Bolts Only	●
M933060065	200	6 x 65mm Set Screws	●
M931060065	200	6 x 65mm Bolts Only	
M933060070	200	6 x 70mm Set Screws	●
M931060070	200	6 x 70mm Bolts Only	●
M931060075	200	6 x 75 Bolts Only	
M933060080	200	6 x 80mm Set Screws	●
M931060080	200	6 x 80mm Bolts Only	●
M931060085	200	6 x 8mm Bolts Only	
M933060090	200	6 x 90mm Set Screws	●
M931060090	200	6 x 90mm Bolts Only	●
M933060100	100	6 x 100mm Set Screws	● ●
M931060100	100	6 x 100mm Bolts Only	●
M931060110	100	6 x 110mm Bolts Only	●
M931060120	100	6 x 120mm Bolts Only	●
M931060130	100	6 x 130mm Bolts Only	●
M931060140	100	6 x 140mm Bolts Only	●
M931060150	100	6 x 150mm Bolts Only	●

7 x 1.00 ISO			
M93307016	200 qty	7 x 16mm Set Screws	● ●
M93307020	200	7 x 20mm Set Screws	● ●
M93307025	200	7 x 25mm Set Screws	● ●
M93307030	200	7 x 30mm Set Screws	● ●
M93307035	200	7 x 35mm Set Screws	● ●
M93307040	200	7 x 40mm Set Screws	● ●
M93307050	200	7 x 50mm Set Screws	● ●
M93107050	200	7 x 50mm Bolts Only	●
M93307060	200	7 x 60mm Set Screws	●
M93107060	200	7 x 60mm Bolts Only	●

8 x 1.25 ISO			
M933080010	200 qty	8 x 10mm Set Screws	● ●
M933080012	200	8 x 12mm Set Screws	●
M933080016	200	8 x 16mm Set Screws	● ●
M933080020	200	8 x 20mm Set Screws	● ●
M933080025	200	8 x 25mm Set Screws	● ●
M933080030	200	8 x 30mm Set Screws	● ●
M933080035	200	8 x 35mm Set Screws	● ●
M931080035	200	8 x 35mm Bolts Only	
M933080040	200	8 x 40mm Set Screws	● ●
M931080040	200	8 x 40mm Bolts Only	
M933080045	200	8 x 45mm Set Screws	●
M931080045	200	8 x 45mm Bolts Only	
M933080050	200	8 x 50mm Set Screws	● ●
M931080050	200	8 x 50mm Bolts Only	●
M931060055	200	6 x 55mm Bolts Only	

METRIC, HIGH TENSILE, GR8.8 BOLTS & SET SCREWS

GRADE 8.8, HIGH TENSILE, A.S. 1100 – DIN 931 & 933

- FULLY THREADED
- ZINC PLATED



8 x 1.25 ISO *Continued*

M933080060	200 qty	8 x 60mm Set Screws	●	●
M931080060	200	8 x 60mm Bolts Only		●
M933080065	200	8 x 65mm Set Screws	●	●
M931080065	200	8 x 65mm Bolts Only		●
M933080070	200	8 x 70mm Set Screws	●	●
M931080070	200	8 x 70mm Bolts Only		●
M933080075	200	8 x 75mm Set Screws	●	●
M931080075	200	8 x 75mm Bolts Only		●
M933080080	200	8 x 80mm Set Screws	●	
M931080080	200	8 x 80mm Bolts Only		●
M931080085	100	8 x 85mm Bolts Only		
M933080090	100	8 x 90mm Set Screws	●	
M931080090	100	8 x 90mm Bolts Only		●
M933080100	100	8 x 100mm Set Screws	●	●
M931080100	100	8 x 100mm Bolts Only		●
M931080110	100	8 x 110mm Bolts Only		●
M931080115	100	8 x 115mm Bolts Only		
M933080120	100	8 x 120mm Set Screws	●	
M931080120	100	8 x 120mm Bolts Only		●
M931080130	100	8 x 130mm Bolts Only		●
M931080140	100	8 x 140mm Bolts Only		●
M931080150	50	8 x 150mm Bolts Only		●
M931080155	25	8 x 155mm Bolts Only		
M931080160	25	8 x 160mm Bolts Only		
M931080170	25	8 x 170mm Bolts Only		
M931080180	25	8 x 180mm Bolts Only		
M931080200	25	8 x 200mm Bolts Only		
M931080220	25	8 x 220mm Bolts Only		

10 x 1.5 ISO

M933100014	100 qty	10 x 14mm Set Screws	●	
M933100016	100	10 x 16mm Set Screws	●	●
M933100020	100	10 x 20mm Set Screws	●	●
M933100025	100	10 x 25mm Set Screws	●	●
M933100030	100	10 x 30mm Set Screws	●	●
M933100035	100	10 x 35mm Set Screws	●	●
M931100035	100	10 x 35mm Bolts Only		
M933100040	100	10 x 40mm Set Screws	●	●
M931100040	100	10 x 40mm Bolts Only		
M933100045	100	10 x 45mm Set Screws	●	●
M931100045	100	10 x 45mm Bolts Only		●
M933100050	100	10 x 50mm Set Screws	●	●
M931100050	100	10 x 50mm Bolts Only		●
M933100055	100	10 x 55mm Set Screws	●	
M933100060	100	10 x 60mm Set Screws	●	●

10 x 1.5 ISO *Continued*

M931100060	100 qty	10 x 60mm Bolts Only		●
M933100065	100	10 x 65mm Set Screws	●	
M931100065	100	10 x 65mm Bolts Only		●
M933100070	100	10 x 70mm Set Screws	●	
M931100070	100	10 x 70mm Bolts Only		●
M933100075	100	10 x 75mm Set Screws	●	
M931100075	100	10 x 75mm Bolts Only		●
M933100080	100	10 x 80mm Set Screws	●	
M931100080	100	10 x 80mm Bolts Only		●
M931100085	100	10 x 85mm Bolts Only		
M933100090	100	10 x 90mm Set Screws	●	
M931100090	100	10 x 90mm Bolts Only		●
M933100100	100	10 x 100mm Set Screws	●	●
M931100100	100	10 x 100mm Bolts Only		●
M931100110	50	10 x 110mm Bolts Only		●
M931100120	50	10 x 120mm Bolts Only		●
M931100130	50	10 x 130mm Bolts Only		●
M931100140	50	10 x 140mm Bolts Only		●
M931100150	50	10 x 150mm Bolts Only		●
M931100160	25	10 x 160mm Bolts Only		
M931100170	25	10 x 170mm Bolts Only		
M931100180	25	10 x 180mm Bolts Only		
M931100190	25	10 x 190mm Bolts Only		
M931100200	25	10 x 200mm Bolts Only		
M931100220	25	10 x 220mm Bolts Only		

12 x 1.75 ISO

M933120020	100 qty	12 x 20mm Set Screws	●	●
M933120025	100	12 x 25mm Set Screws	●	●
M933120030	100	12 x 30mm Set Screws	●	●
M933120035	100	12 x 35mm Set Screws	●	●
M933120040	100	12 x 40mm Set Screws	●	●
M931120040	100	12 x 40mm Bolts Only		●
M933120045	100	12 x 45mm Set Screws	●	●
M931120045	100	12 x 45mm Bolts Only		●
M933120050	100	12 x 50mm Set Screws	●	●
M931120050	100	12 x 50mm Bolts Only		●
M933120055	100	12 x 55mm Set Screws	●	
M931120055	100	12 x 55mm Bolts Only		
M933120060	100	12 x 60mm Set Screws	●	●
M931120060	50	12 x 60mm Bolts Only		●
M933120065	50	12 x 65mm Set Screws	●	●
M931120065	50	12 x 65mm Bolts Only		●
M933120070	50	12 x 70mm Set Screws	●	●
M931120070	50	12 x 70mm Bolts Only		●
M933120075	50	12 x 75mm Set Screws	●	●
M931120075	50	12 x 75mm Bolts Only		●
M933120080	50	12 x 80mm Set Screws	●	●
M931120080	50	12 x 80mm Bolts Only		●

METRIC, HIGH TENSILE, GR8.8 BOLTS & SET SCREWS

GRADE 8.8, HIGH TENSILE A.S. 1100 – DIN 931 & 933

- FULLY THREADED
- ZINC PLATED



12 x 1.75 ISO <i>Continued</i>				
M933120090	50 qty	12 x 90mm Set Screws	●	
M931120090	50	12 x 90mm Bolts Only		●
M933120100	50	12 x 100mm Set Screws	●	●
M931120100	50	12 x 100mm Bolts Only		●
M931120110	50	12 x 110mm Bolts Only		●
M933120120	50	12 x 120mm Set Screws	●	
M931120120	50	12 x 120mm Bolts Only		●
M933120130	50	12 x 130mm Set Screws	●	
M931120130	50	12 x 130mm Bolts Only		●
M931120140	50	12 x 140mm Bolts Only		●
M931120150	50	12 x 150mm Bolts Only		●
M931120160	25	12 x 160mm Bolts Only		
M931120170	25	12 x 170mm Bolts Only		
M931120180	25	12 x 180mm Bolts Only		
M931120190	25	12 x 190mm Bolts Only		
M931120200	25	12 x 200mm Bolts Only		
M931120220	25	12 x 220mm Bolts Only		
14 x 2.00 ISO				
M933140020	100 qty	14 x 20mm Set Screws	●	
M933140025	100	14 x 25mm Set Screws	●	
M933140030	100	14 x 30mm Set Screws	●	
M933140035	100	14 x 35mm Set Screws	●	
M933140040	100	14 x 40mm Set Screws	●	
M933140045	50	14 x 45mm Set Screws	●	
M933140050	50	14 x 50mm Set Screws	●	
M931140050	50	14 x 50mm Bolts Only		
M933140055	50	14 x 55mm Set Screws	●	
M933140060	50	14 x 60mm Set Screws	●	
M931140060	50	14 x 60mm Bolts Only		
M931140065	50	14 x 65mm Bolts Only		
M933140075	50	14 x 75mm Set Screws	●	
M931140075	50	14 x 75mm Bolts Only		
M933140080	50	14 x 80mm Set Screws	●	
M931140080	50	14 x 80mm Bolts Only		
M931140090	50	14 x 90mm Bolts Only		
M933140100	50	14 x 100mm Set Screws	●	
M931140100	50	14 x 100mm Bolts Only		
M931140120	50	14 x 120mm Bolts Only		
M931140130	50	14 x 130mm Bolts Only		
M931140140	25	14 x 140mm Bolts Only		
M931140150	25	14 x 150mm Bolts Only		
M931140160	25	14 x 160mm Bolts Only		
M931140180	25	14 x 180mm Bolts Only		
M931140200	25	14 x 200mm Bolts Only		
M931140220	25	14 x 220mm Bolts Only		
M931140240	25	14 x 240mm Bolts Only		
M931140260	25	14 x 260mm Bolts Only		

16 x 2.00 ISO				
M933160025	50 qty	16 x 25mm Set Screws	●	
M933160030	50	16 x 30mm Set Screws	●	
M933160035	50	16 x 35mm Set Screws	●	
M933160040	50	16 x 40mm Set Screws	●	
M933160045	50	16 x 45mm Set Screws	●	
M933160050	50	16 x 50mm Set Screws	●	
M933160055	50	16 x 55mm Set Screws	●	
M931160055	50	16 x 55mm Bolts Only		
M933160060	50	16 x 60mm Set Screws	●	
M931160060	50	16 x 60mm Bolts Only		
M933160065	25	16 x 65mm Set Screws	●	
M931160065	25	16 x 65mm Bolts Only		
M933160070	25	16 x 70mm Set Screws	●	
M931160070	25	16 x 70mm Bolts Only		
M933160075	25	16 x 75mm Set Screws	●	
M931160075	25	16 x 75mm Bolts Only		
M933160080	25	16 x 80mm Set Screws	●	
M931160080	25	16 x 80mm Bolts Only		
M931160085	25	16 x 85mm Bolts Only		
M933160090	25	16 x 90mm Set Screws	●	
M931160090	25	16 x 90mm Bolts Only		
M933160100	25	16 x 100mm Set Screws	●	
M931160100	25	16 x 100mm Bolts Only		
M931160110	25	16 x 110mm Bolts Only		
M931160120	25	16 x 120mm Bolts Only		
M931160130	25	16 x 130mm Bolts Only		
M931160140	25	16 x 140mm Bolts Only		
M931160150	25	16 x 150mm Bolts Only		
M931160160	10	16 x 160mm Bolts Only		
M931160170	10	16 x 170mm Bolts Only		
M931160180	10	16 x 180mm Bolts Only		
M931160190	5	16 x 190mm Bolts Only		
M931160200	5	16 x 200mm Bolts Only		
M931160220	5	16 x 220mm Bolts Only		
M931160240	5	16 x 240mm Bolts Only		
M931160260	5	16 x 260mm Bolts Only		
M931160280	5	16 x 280mm Bolts Only		
M931160300	5	16 x 300mm Bolts Only		
18 x 2.5 ISO				
M933180040	50 qty	18 x 40mm Set Screws	●	
M933180050	50	18 x 50mm Set Screws	●	
M933180060	25	18 x 60mm Set Screws	●	
M931180060	25	18 x 60mm Bolts Only		
M931180070	25	18 x 70mm Bolts Only		
M933180075	25	18 x 75mm Set Screws	●	
M931180075	25	18 x 75mm Bolts Only		
M931180080	25	18 x 80mm Bolts Only		

METRIC, HIGH TENSILE, GR8.8 BOLTS & SET SCREWS

GRADE 8.8, HIGH TENSILE A.S. 1100 – DIN 931 & 933

- FULLY THREADED
- ZINC PLATED



18 x 2.5 ISO <i>Continued</i>			
M933180090	25 qty	18 x 90mm Set Screws	●
M931180090	25	18 x 90mm Bolts Only	
M933180100	25	18 x 100mm Set Screws	●
M931180100	25	18 x 100mm Bolts Only	
M931180110	25	18 x 110mm Bolts Only	
M931180120	25	18 x 120mm Bolts Only	
M931180140	25	18 x 140mm Bolts Only	
M931180150	25	18 x 150mm Bolts Only	

20 x 2.5 ISO			
M933200035	25 qty	20 x 35mm Set Screws	●
M933200040	25	20 x 40mm Set Screws	●
M933200045	25	20 x 45mm Set Screws	●
M933200050	25	20 x 50mm Set Screws	●
M933200055	25	20 x 55mm Set Screws	●
M933200060	25	20 x 60mm Set Screws	●
M933200065	25	20 x 65mm Set Screws	●
M931200065	25	20 x 65mm Bolts Only	
M933200070	25	20 x 70mm Set Screws	●
M931200070	25	20 x 70mm Bolts Only	
M933200075	25	20 x 75mm Set Screws	●
M931200075	25	20 x 75mm Bolts Only	
M933200080	25	20 x 80mm Set Screws	●
M931200080	25	20 x 80mm Bolts Only	
M933200090	25	20 x 90mm Set Screws	●
M931200090	25	20 x 90mm Bolts Only	
M933200100	25	20 x 100mm Set Screws	●
M931200100	25	20 x 100mm Bolts Only	
M931200120	25	20 x 120mm Bolts Only	
M931200130	25	20 x 130mm Bolts Only	
M931200140	25	20 x 140mm Bolts Only	
M931200150	25	20 x 150mm Bolts Only	
M931200160	25	20 x 160mm Bolts Only	
M931200180	25	20 x 180mm Bolts Only	
M933200200	10	20 x 200mm Set Screws	●

22 x 2.5 ISO			
M933220040	25 qty	22 x 40mm Set Screws	●
M933220050	25	22 x 50mm Set Screws	●
M933220055	25	22 x 55mm Set Screws	●
M933220060	25	22 x 60mm Set Screws	●
M933220065	25	22 x 65mm Set Screws	●
M933220070	25	22 x 70mm Set Screws	●
M931220070	25	22 x 70mm Bolts Only	
M933220080	25	22 x 80mm Set Screws	●
M931220080	25	22 x 80mm Bolts Only	
M931220090	25	22 x 90mm Bolts Only	
M933220100	10	22 x 100mm Set Screws	●
M931220100	10	22 x 100mm Bolts Only	
M931220120	10	22 x 120mm Bolts Only	
M931220130	10	22 x 130mm Bolts Only	
M931220150	10	22 x 150mm Bolts Only	

24 x 3.00 ISO			
M933240040	25 qty	24 x 40mm Set Screws	●
M933240050	25	24 x 50mm Set Screws	●
M933240060	25	24 x 60mm Set Screws	●
M933240065	25	24 x 65mm Set Screws	●
M933240070	25	24 x 70mm Set Screws	●
M933240075	25	24 x 75mm Set Screws	●
M931240075	25	24 x 75mm Bolts Only	
M933240080	25	24 x 80mm Set Screws	●
M931240080	25	24 x 80mm Bolts Only	
M931240090	25	24 x 90mm Bolts Only	
M933240100	10	24 x 100mm Set Screws	●
M931240100	10	24 x 100mm Bolts Only	
M931240110	10	24 x 110mm Bolts Only	
M931240120	10	24 x 120mm Bolts Only	
M933240130	10	24 x 130mm Set Screws	●
M931240130	10	24 x 130mm Bolts Only	
M933240150	10	24 x 150mm Set Screws	●
M931240150	10	24 x 150mm Bolts Only	
M931240160	10	24 x 160mm Bolts Only	
M933240170	10	24 x 170mm Set Screws	●
M931240170	10	24 x 170mm Bolts Only	
M931240180	10	24 x 180mm Bolts Only	
M933240200	10	24 x 200mm Set Screws	●
M931240200	10	24 x 200mm Bolts Only	

HEX FLANGE BOLTS			
M93305016FB	200 qty	5 x 16mm – 8AF	● ●
M93305025FB	200	5 x 25mm – 8AF	● ●
M933060016FB	200	6 x 16mm – 10AF	● ●
M933060020FB	200	6 x 20mm – 10AF	● ●
M933060025FB	200	6 x 25mm – 10AF	● ●
M933060030FB	200	6 x 30mm – 10AF	● ●
M933060040FB	200	6 x 40mm – 10AF	● ●
M933080016FB	200	8 x 16mm – 12AF	● ●
M933080020FB	200	8 x 20mm – 12AF	● ●
M933080025FB	200	8 x 25mm – 12AF	● ●
M933080030FB	200	8 x 30mm – 12AF	● ●
M933080040FB	200	8 x 40mm – 12AF	● ●
M933080050FB	200	8 x 50mm – 12AF	● ●
961125100025FB	200	10 x 25 x 1.25mm – 14AF	● ●
961125100035FB	200	10 x 35 x 1.25mm – 14AF	● ●
961125100040FB	200	10 x 40 x 1.25mm – 14AF	● ●
961125100050FB	200	10 x 50 x 1.25mm – 14AF	● ●

STANDARD
PACKS

METRIC, HIGH TENSILE, GR8.8 BOLTS & SET SCREWS

GRADE 8.8, HIGH TENSILE A.S. 1100 – DIN 960 & 961

- FULLY THREADED
- ZINC PLATED



8 x 1.00 FINE				
961100080016	200 qty	8 x 16 x 1.00mm Set Screws	●	
961100080020	200	8 x 20 x 1.00mm Set Screws	●	
961100080025	200	8 x 25 x 1.00mm Set Screws	●	
961100080030	200	8 x 30 x 1.00mm Set Screws	●	
961100080035	200	8 x 35 x 1.00mm Set Screws	●	●
961100080040	200	8 x 40 x 1.00mm Set Screws	●	
961100080045	100	8 x 45 x 1.00mm Set Screws	●	
961100080050	100	8 x 50 x 1.00mm Set Screws	●	
960100080050	100	8 x 50 x 1.00mm Bolts Only		●
960100080060	100	8 x 60 x 1.00mm Bolts Only		
960100080070	100	8 x 70 x 1.00mm Bolts Only		
960100080080	100	8 x 80 x 1.00mm Bolts Only		
960100080100	100	8 x 100 x 1.00mm Bolts Only		
960100080110	100	8 x 110 x 1.00mm Bolts Only		
960100080120	100	8 x 120 x 1.00mm Bolts Only		

10 x 1.00 FINE				
961100100020	200 qty	10 x 20 x 1.00mm Set Screws	●	●
961100100025	200	10 x 25 x 1.00mm Set Screws	●	●
961100100030	200	10 x 30 x 1.00mm Set Screws	●	●
961100100035	100	10 x 35 x 1.00mm Set Screws	●	●
961100100040	100	10 x 40 x 1.00mm Set Screws	●	●
961100100050	100	10 x 50 x 1.00mm Set Screws	●	●
960100100050	100	10 x 50 x 1.00 Bolts Only		
960100100060	100	10 x 60 x 1.00 Bolts Only		
960100100070	100	10 x 70 x 1.00 Bolts Only		
960100100080	100	10 x 80 x 1.00 Bolts Only		
960100100100	100	10 x 100 x 1.00 Bolts Only		

10 x 1.25 FINE				
961125100020	200 qty	10 x 20 x 1.25mm Set Screws	●	
961125100025	200	10 x 25 x 1.25mm Set Screws	●	●
961125100030	200	10 x 30 x 1.25mm Set Screws	●	●
961125100035	100	10 x 35 x 1.25mm Set Screws	●	●
961125100040	100	10 x 40 x 1.25mm Set Screws	●	●
960125100040	100	10 x 40 x 1.25mm Bolts Only		
961125100045	100	10 x 45 x 1.25mm Set Screws	●	●
960125100045	100	10 x 45 x 1.25mm Bolts Only		
961125100050	100	10 x 50 x 1.25mm Set Screws	●	●
960125100050	100	10 x 50 x 1.25mm Bolts Only		●
960125100055	100	10 x 55 x 1.25mm Bolts Only		
960125100060	100	10 x 60 x 1.25mm Bolts Only		●
961125100065	50	10 x 65 x 1.25mm Set Screws	●	
960125100065	50	10 x 65 x 1.25mm Bolts Only		
961125100070	50	10 x 70 x 1.25mm Set Screws	●	
960125100070	50	10 x 70 x 1.25mm Bolts Only		●
961125100075	50	10 x 75 x 1.25mm Set Screws	●	
960125100075	50	10 x 75 x 1.25mm Bolts Only		

10 x 1.25 FINE <i>Continued</i>				
960125100080	50 qty	10 x 80 x 1.25mm Bolts Only		●
960125100090	50	10 x 90 x 1.25mm Bolts Only		●
961125100100	50	10 x 100 x 1.25mm Set Screws	●	
960125100100	50	10 x 100 x 1.25mm Bolts Only		●
960125100110	50	10 x 110 x 1.25mm Bolts Only		
960125100120	50	10 x 120 x 1.25mm Bolts Only		
960125100130	50	10 x 130 x 1.25mm Bolts Only		
960125100140	50	10 x 140 x 1.25mm Bolts Only		
960125100150	50	10 x 150 x 1.25mm Bolts Only		
960125100160	25	10 x 160 x 1.25mm Bolts Only		
960125100180	25	10 x 180 x 1.25mm Bolts Only		
960125100200	25	10 x 200 x 1.25mm Bolts Only		
960125100220	25	10 x 220 x 1.25mm Bolts Only		

12 x 1.25 FINE				
961125120020	100 qty	12 x 20 x 1.25mm Set Screws	●	●
961125120025	100	12 x 25 x 1.25mm Set Screws	●	●
961125120030	100	12 x 30 x 1.25mm Set Screws	●	●
961125120035	100	12 x 35 x 1.25mm Set Screws	●	●
961125120040	100	12 x 40 x 1.25mm Set Screws	●	●
961125120045	100	12 x 45 x 1.25mm Set Screws	●	●
961125120050	100	12 x 50 x 1.25mm Set Screws	●	●
960125120050	50	12 x 50 x 1.25mm Bolts Only		●
960125120055	50	12 x 55 x 1.25mm Bolts Only		
961125120060	100	12 x 60 x 1.25mm Set Screws	●	●
960125120060	50	12 x 60 x 1.25mm Bolts Only		●
960125120065	50	12 x 65 x 1.25mm Bolts Only		
960125120070	50	12 x 70 x 1.25mm Bolts Only		●
960125120075	50	12 x 75 x 1.25mm Bolts Only		●
960125120080	50	12 x 80 x 1.25mm Bolts Only		●
960125120090	50	12 x 90 x 1.25mm Bolts Only		●
961125120100	50	12 x 100 x 1.25mm Set Screws	●	
960125120100	50	12 x 100 x 1.25mm Bolts Only		●
960125120120	50	12 x 120 x 1.25mm Bolts Only		
960125120150	50	12 x 150 x 1.25mm Bolts Only		

12 x 1.5 FINE				
961150120020	100 qty	12 x 20 x 1.5mm Set Screws	●	
961150120025	100	12 x 25 x 1.5mm Set Screws	●	
961150120030	100	12 x 30 x 1.5mm Set Screws	●	●
961150120035	100	12 x 35 x 1.5mm Set Screws	●	●
961150120040	100	12 x 40 x 1.5mm Set Screws	●	
960150120040	100	12 x 40 x 1.5mm Bolts Only		●
961150120045	100	12 x 45 x 1.5mm Set Screws	●	●
960150120045	100	12 x 45 x 1.5mm Bolts Only		
961150120050	100	12 x 50 x 1.5mm Set Screws	●	●
960150120050	100	12 x 50 x 1.5mm Bolts Only		●
961150120055	100	12 x 55 x 1.5mm Set Screws	●	
960150120055	100	12 x 55 x 1.5mm Bolts Only		

METRIC, HIGH TENSILE, GR8.8 BOLTS & SET SCREWS

GRADE 8.8, HIGH TENSILE A.S. 1100 – DIN 960 & 961

- FULLY THREADED
- ZINC PLATED



12 x 1.5 FINE <i>Continued</i>			
960150120060	100 qty	12 x 60 x 1.5mm Bolts Only	●
960150120065	50	12 x 65 x 1.5mm Bolts Only	
960150120070	50	12 x 70 x 1.5mm Bolts Only	
960150120075	50	12 x 75 x 1.5mm Bolts Only	●
961150120100	50	12 x 100 x 1.5mm Set Screws	●
960150120100	50	12 x 100 x 1.5mm Bolts Only	
960150120120	50	12 x 120 x 1.5mm Bolts Only	
960150120150	50	12 x 150 x 1.5mm Bolts Only	

14 x 1.5 FINE			
961150140025	100 qty	14 x 25 x 1.5mm Set Screws	●
961150140030	100	14 x 30 x 1.5mm Set Screws	●
961150140035	100	14 x 35 x 1.5mm Set Screws	●
961150140040	100	14 x 40 x 1.5mm Set Screws	●
961150140045	50	14 x 45 x 1.5mm Set Screws	●
961150140050	50	14 x 50 x 1.5mm Set Screws	●
960150140050	50	14 x 50 x 1.5mm Bolts Only	
961150140060	50	14 x 60 x 1.5mm Set Screws	●
960150140060	50	14 x 60 x 1.5mm Bolts Only	
960150140070	50	14 x 70 x 1.5mm Bolts Only	
960150140075	50	14 x 75 x 1.5mm Bolts Only	
960150140080	50	14 x 80 x 1.5mm Bolts Only	
960150140090	50	14 x 90 x 1.5mm Bolts Only	
961150140100	50	14 x 100 x 1.5mm Set Screws	●
960150140100	50	14 x 100 x 1.5mm Bolts Only	
960150140120	50	14 x 120 x 1.5mm Bolts Only	
960150140150	50	14 x 150 x 1.5mm Bolts Only	

16 x 1.5 FINE			
961150160025	50 qty	16 x 25 x 1.5mm Set Screws	●
961150160030	50	16 x 30 x 1.5mm Set Screws	●
961150160035	50	16 x 35 x 1.5mm Set Screws	●
961150160040	50	16 x 40 x 1.5mm Set Screws	●
961150160045	50	16 x 45 x 1.5mm Set Screws	●
961150160050	50	16 x 50 x 1.5mm Set Screws	●
960150160050	50	16 x 50 x 1.5mm Bolts Only	
961150160060	50	16 x 60 x 1.5mm Set Screws	●
960150160060	50	16 x 60 x 1.5mm Bolts Only	
961150160065	25	16 x 65 x 1.5mm Set Screws	●
960150160065	25	16 x 65 x 1.5mm Bolts Only	
960150160070	25	16 x 70 x 1.5mm Bolts Only	
960150160080	25	16 x 80 x 1.5mm Bolts Only	
960150160090	25	16 x 90 x 1.5mm Bolts Only	
960150160100	25	16 x 100 x 1.5mm Bolts Only	
960150160120	25	16 x 120 x 1.5mm Bolts Only	
960150160150	25	16 x 150 x 1.5mm Bolts Only	

18 x 1.5 FINE			
961150180025	50 qty	18 x 25 x 1.5mm Set Screws	●
961150180030	50	18 x 30 x 1.5mm Set Screws	●
961150180035	50	18 x 35 x 1.5mm Set Screws	●
961150180040	50	18 x 40 x 1.5mm Set Screws	●
961150180045	50	18 x 45 x 1.5mm Set Screws	●
961150180050	50	18 x 50 x 1.5mm Set Screws	●
961150180060	50	18 x 60 x 1.5mm Set Screws	●
960150180060	50	18 x 60 x 1.5mm Bolts Only	
960150180065	25	18 x 65 x 1.5mm Bolts Only	
960150180070	25	18 x 70 x 1.5mm Bolts Only	
960150180080	25	18 x 80 x 1.5mm Bolts Only	
960150180100	25	18 x 100 x 1.5mm Bolts Only	
960150180120	25	18 x 120 x 1.5mm Bolts Only	

20 x 1.5 FINE			
961150200050	25 qty	20 x 50 x 1.5mm Set Screws	●
961150200060	25	20 x 60 x 1.5mm Set Screws	●
960150200060	25	20 x 60 x 1.5mm Bolts Only	
960150200070	25	20 x 70 x 1.5mm Bolts Only	
961150200080	25	20 x 80 x 1.5mm Set Screws	●
960150200080	25	20 x 80 x 1.5mm Bolts Only	
961150200100	25	20 x 100 x 1.5mm Set Screws	●
960150200100	25	20 x 100 x 1.5mm Bolts Only	
961150200120	25	20 x 120 x 1.5mm Set Screws	●
960150200120	25	20 x 120 x 1.5mm Bolts Only	

22 x 1.5 FINE			
961150220060	10 qty	22 x 60 x 1.5mm Set Screws	●
960150220100	10	22 x 100 x 1.5mm Bolts Only	
960150220120	10	22 x 120 x 1.5mm Bolts Only	

24 x 1.5 FINE			
961150240060	25 qty	24 x 60 x 1.5mm Set Screws	●
960150240060	25	24 x 60 x 1.5mm Bolts Only	
961150240080	10	24 x 80 x 1.5mm Set Screws	●
960150240080	10	24 x 80 x 1.5mm Bolts Only	
960150240120	5	24 x 120 x 1.5mm Bolts Only	

24 x 2.00 FINE			
960200240080	25 qty	24 x 80 x 2.00mm Bolts Only	●
960200240100	10	24 x 100 x 2.00mm Bolts Only	
960200240120	10	24 x 120 x 2.00mm Bolts Only	

STANDARD
PACKS

METRIC, HIGH TENSILE, HEX NUTS & SOCKET SET CAP SCREWS

HEX PLAIN NUTS A.S. 1112 – **DIN 934**, CLASS 8.

HEX FLANGE NUTS – **DIN 6923**, CLASS 8 (Serrated)

- ZINC PLATED
- PLAIN FINISH

NYLON INSERT SELF-LOCKING NUTS – **DIN 985**

SOCKET SET CAP SCREWS – **DIN 912** (Available in 8.8/12.9)

HEX PLAIN NUTS

M93403005	200 qty	3 x 0.5mm	●	
M93404007	200	4 x 0.7mm	●	
M93405008	200	5 x 0.8mm	●	
M93405009	200	5 x 0.9mm	●	
M93406100	200	6 x 1.00mm	●	
M93407100	200	7 x 1.00mm	●	
M93408100	200	8 x 1.00mm	●	
M93408125	200	8 x 1.25mm	●	
M93408125-12AF	200	8 x 1.25mm 12AF	●	
M93410100	200	10 x 1.00mm	●	
M93410125	200	10 x 1.25mm	●	
M93410125-14AF	200	10 x 1.25mm 14AF	●	
M93410150	200	10 x 1.5mm	●	
M93412125	100	12 x 1.25mm	●	
M93412150	100	12 x 1.5mm	●	
M93412175	100	12 x 1.75mm	●	
M93414150	100	14 x 1.5mm	●	
M93414200	100	14 x 2.00mm	●	
M93416150	50	16 x 1.5mm	●	
M93416200	50	16 x 2.00mm	●	
M93418150	50	18 x 1.5mm	●	
M93418250	50	18 x 2.5mm	●	
M93420150	50	20 x 1.5mm	●	
M93420200	50	20 x 2.0mm	●	
M93420250	50	20 x 2.5mm	●	
M93422150	50	22 x 1.5mm	●	
M93422250	50	22 x 2.5mm	●	
M93424150	50	24 x 1.5mm	●	
M93424200	50	24 x 2.0mm	●	
M93424300	50	24 x 3.0mm	●	
M93427300	50	27 x 3.0mm	●	
M93430150	50	30 x 1.5mm	●	
M93430350	50	30 x 3.5mm	●	
M93433350	50	33 x 3.5mm	●	
M93436400	25	36 x 4.0mm	●	
M93439400	15	39 x 4.0mm	●	
M93442450	10	42 x 4.5mm	●	
M93448500	10	48 x 5.0mm	●	

NYLON INSERT SELF-LOCKING NUTS

M98503005	100 qty	3 x 0.5mm ISO	●	
M98504007	100	4 x 0.7mm ISO	●	
M98505008	100	5 x 0.8mm ISO	●	
M98506100	100	6 x 1.00mm ISO	●	
M98507100	100	7 x 1.00mm ISO	●	
M98508100	100	8 x 1.00mm FINE	●	
M98508125	100	8 x 1.25mm ISO	●	
M98510150	100 qty	10 x 1.5mm ISO	●	
M98512125	100	12 x 1.25mm FINE	●	
M98512150	100	12 x 1.5mm FINE	●	
M98512175	100	12 x 1.75mm ISO	●	
M98514150	100	14 x 1.5mm FINE	●	
M98514200	100	14 x 2.00mm ISO	●	
M98516150	100	16 x 1.5mm FINE	●	
M98516200	100	16 x 2.00mm ISO	●	
M98518150	50	18 x 1.5mm FINE	●	
M98518250	50	18 x 2.5mm ISO	●	
M98520150	50	20 x 1.5mm FINE	●	
M98520250	50	20 x 2.5mm ISO	●	
M98522250	25	22 x 2.5mm ISO	●	
M98524150	25	24 x 1.50mm FINE	●	
M98524200	25	24 x 2.00mm FINE	●	
M98524300	25	24 x 3.00mm ISO	●	

NYLON INSERT SELF-LOCKING NUTS *Continued*

M98510150	100 qty	10 x 1.5mm ISO	●	
M98512125	100	12 x 1.25mm FINE	●	
M98512150	100	12 x 1.5mm FINE	●	
M98512175	100	12 x 1.75mm ISO	●	
M98514150	100	14 x 1.5mm FINE	●	
M98514200	100	14 x 2.00mm ISO	●	
M98516150	100	16 x 1.5mm FINE	●	
M98516200	100	16 x 2.00mm ISO	●	
M98518150	50	18 x 1.5mm FINE	●	
M98518250	50	18 x 2.5mm ISO	●	
M98520150	50	20 x 1.5mm FINE	●	
M98520250	50	20 x 2.5mm ISO	●	
M98522250	25	22 x 2.5mm ISO	●	
M98524150	25	24 x 1.50mm FINE	●	
M98524200	25	24 x 2.00mm FINE	●	
M98524300	25	24 x 3.00mm ISO	●	

HEX FLANGE NUTS

FN05008	200 qty	5 x 0.8mm ISO	●	
FN06100	200	6 x 1.00mm ISO	●	
FN08125	200	8 x 1.25mm ISO	●	
FN10125	200	10 x 1.25mm FINE	●	
FN10150	200	10 x 1.5mm ISO	●	
FN12125	200	12 x 1.25mm FINE	●	
FN12175	200	12 x 1.75mm ISO	●	
FN15150	100	15 x 1.5mm ISO	●	
FN16150	100	16 x 1.5mm ISO	●	
FN18150	50	18 x 1.5mm ISO	●	

SOCKET HEAD CAP SCREWS

M91203006	100 qty	3 x 6mm	●	
M91203010	100	3 x 10mm	●	
M91203012	100	3 x 12mm	●	
M91203016	100	3 x 16mm	●	
M91203020	100	3 x 20mm	●	
M91203025	100	3 x 25mm	●	
M91203030	100	3 x 30mm	●	
M91204008	100	4 x 8mm	●	
M91204010	100	4 x 10mm	●	
M91204012	100	4 x 12mm	●	
M91204016	100	4 x 16mm	●	
M91204020	100	4 x 20mm	●	
M91204025	100	4 x 25mm	●	
M91204030	100	4 x 30mm	●	
M91204040	100	4 x 40mm	●	
M91205010	100	5 x 10mm	●	
M91205012	100	5 x 12mm	●	
M91205016	100	5 x 16mm	●	

METRIC, HIGH TENSILE, SOCKET SET CAP SCREWS *Continued*

SOCKET SET CAP SCREWS – DIN 912 (Available in 8.8/12.9)

- ZINC PLATED
- PLAIN FINISH

SOCKET HEAD CAP SCREWS *Continued*

M91205020	100 qty	5 x 20mm	●	
M91205025	100	5 x 25mm	●	
M91205030	100	5 x 30mm	●	
M91205035	100	5 x 35mm	●	
M91205040	100	5 x 40mm	●	
M91205050	100	5 x 50mm	●	
M91206010	100	6 x 10mm	●	
M91206012	100	6 x 12mm	●	
M91206016	100	6 x 16mm	●	
M91206020	100	6 x 20mm	●	
M91206025	100	6 x 25mm	●	
M91206030	100	6 x 30mm	●	
M91206035	100	6 x 35mm	●	
M91206040	100	6 x 40mm	●	
M91206045	100	6 x 45mm	●	
M91206050	100	6 x 50mm	●	
M91206060	100	6 x 60mm	●	
M91206065	100	6 x 65mm	●	
M91206070	100	6 x 70mm	●	
M91206080	100	6 x 80mm	●	
M91206090	100	6 x 90mm	●	
M91206130	100	6 x 130mm	●	
M91208016	100	8 x 16mm	●	
M91208020	100	8 x 20mm	●	
M91208025	100	8 x 25mm	●	
M91208030	100	8 x 30mm	●	
M91208035	100	8 x 35mm	●	
M91208040	100	8 x 40mm	●	
M91208045	100	8 x 45mm	●	
M91208050	100	8 x 50mm	●	
M91208055	100	8 x 55mm	●	
M91208060	100	8 x 60mm	●	
M91208065	100	8 x 65mm	●	
M91208070	100	8 x 70mm	●	
M91208075	100	8 x 75mm	●	
M91208080	100	8 x 80mm	●	
M91208090	100	8 x 90mm	●	
M91208100	100	8 x 100mm	●	
M91210016	100	10 x 16mm	●	
M91210020	100	10 x 20mm	●	
M91210025	100	10 x 25mm	●	
M91210030	100	10 x 30mm	●	
M91210030	100	10 x 30mm	●	
M91210035	100	10 x 35mm	●	

SOCKET HEAD CAP SCREWS *Continued*

M91210040	100 qty	10 x 40mm	●	
M91210045	100	10 x 45mm	●	
M91210050	100	10 x 50mm	●	
M91210055	100	10 x 55mm	●	
M91210060	100	10 x 60mm	●	
M91210065	100	10 x 65mm	●	
M91210070	100	10 x 70mm	●	
M91210075	100	10 x 75mm	●	
M91210080	100	10 x 80mm	●	
M91210100	100	10 x 100mm	●	
M91210110	100	10 x 110mm	●	
M91210120	100	10 x 120mm	●	
M912100150	100	10 x 150mm	●	
M91212020	100	12 x 20mm	●	
M91212025	100	12 x 25mm	●	
M91212030	100	12 x 30mm	●	
M91212035	100	12 x 35mm	●	
M91212040	100	12 x 40mm	●	
M91212045	100	12 x 45mm	●	
M91212050	100	12 x 50mm	●	
M91212055	100	12 x 55mm	●	
M91212060	100	12 x 60mm	●	
M91212065	100	12 x 65mm	●	
M91212070	100	12 x 70mm	●	
M91212080	100	12 x 80mm	●	
M91212090	100	12 x 90mm	●	
M912120120	100	12 x 120mm	●	
M91214040	100	14 x 40mm	●	
M91214045	100	14 x 45mm	●	
M91214050	100	14 x 50mm	●	
M91214060	100	14 x 60mm	●	
M91214070	100	14 x 70mm	●	
M91216035	100	16 x 35mm	●	
M91216050	100	16 x 50mm	●	
M91216080	100	16 x 80mm	●	
M912160300	100	16 x 300mm	●	
M91220090	100	20 x 90mm	●	
M91220100	100	20 x 100mm	●	
M91224070	100	24 x 70mm	●	
M91224100	100	24 x 100mm	●	

IMPERIAL, UNC/UNF, HIGH TENSILE GR5, BOLTS & SET SCREWS

GRADE 5, HIGH TENSILE A.S. 2465 – DIN 931 & 933

- FULLY THREADED
- ZINC PLATED



1/4" UNC

C93304008	200 qty	1/4 x 1/2" UNC Set Screws	●	●
C93304010	200	1/4 x 5/8" UNC Set Screws	●	●
C93304012	200	1/4 x 3/4" UNC Set Screws	●	●
C93304016	200	1/4 x 1" UNC Set Screws	●	●
C93304020	200	1/4 x 1-1/4" UNC Set Screws	●	●
C93104020	200	1/4 x 1-1/4" UNC Bolts Only		●
C93304024	200	1/4 x 1-1/2" UNC Set Screws	●	●
C93104024	200	1/4 x 1-1/2" UNC Bolts Only		●
C93104028	200	1/4 x 1-3/4" UNC Bolts Only		
C93304032	200	1/4 x 2" UNC Set Screws	●	●
C93104032	200	1/4 x 2" UNC Bolts Only		●
C93304040	200	1/4 x 2-1/2" UNC Set Screws	●	●
C93104040	200	1/4 x 2-1/2" UNC Bolts Only		●
C93104048	200	1/4 x 3" UNC Bolts Only		●
C93104056	200	1/4 x 3-1/2" UNC Bolts Only		●
C93104064	200	1/4 x 4" UNC Bolts Only		●

5/16" UNC

C93305008	200 qty	5/16 x 1/2" UNC Set Screws	●	
C93305012	200	5/16 x 3/4" UNC Set Screws	●	●
C93305016	200	5/16 x 1" UNC Set Screws	●	●
C93305020	200	5/16 x 1-1/4" UNC Set Screws	●	●
C93305024	200	5/16 x 1-1/2" UNC Set Screws	●	●
C93105020	200	5/16 x 1-1/4" UNC Bolts		●
C93105024	200	5/16 x 1-1/2" UNC Bolts		●
C93105028	200	5/16 x 1-3/4" UNC Bolts		
C93105032	200	5/16 x 2" UNC Bolts Only		●
C93105040	200	5/16 x 2-1/2" UNC Bolts		●
C93105048	100	5/16 x 3" UNC Bolts Only		●
C93105056	100	5/16 x 3-1/2" UNC Bolts		●
C93105064	100	5/16 x 4" UNC Bolts Only		●
C93105072	100	5/16 x 4-1/2" UNC Bolts		

3/8" UNC

C93306012	100 qty	3/8 x 3/4" UNC Set Screws	●	●
C93306014	100	3/8 x 7/8" UNC Set Screws	●	
C93306016	100	3/8 x 1" UNC Set Screws	●	●
C93306020	100	3/8 x 1-1/4" UNC Set Screws	●	●
C93306024	100	3/8 x 1-1/2" UNC Set Screws	●	●
C93106024	100	3/8 x 1-1/2" UNC Bolts Only		●
C93106028	100	3/8 x 1-3/4" UNC Bolts Only		●
C93306032	100	3/8 x 2" UNC Set Screws	●	●
C93106032	100	3/8 x 2" UNC Bolts Only		●
C93306040	100	3/8 x 2-1/2" UNC Set Screws	●	●
C93106040	100	3/8 x 2-1/2" UNC Bolts Only		●
C93306048	50	3/8 x 3" UNC Set Screws		●
C93106048	50	3/8 x 3" UNC Bolts Only		●

3/8" UNC *Continued*

C93106056	50 qty	3/8 x 3-1/2" UNC Bolts Only		●
C93106060	50	3/8 x 3-3/4" UNC Bolts Only		
C93106064	50	3/8 x 4" UNC Bolts Only		●
C93106072	50	3/8 x 4-1/2" UNC Bolts Only		
C93106080	50	3/8 x 5" UNC Bolts Only		
C93106088	50	3/8 x 5-1/2" UNC Bolts Only		
C93106096	50	3/8 x 6" UNC Bolts GR5		

7/16" UNC

C93307014	100 qty	7/16 x 7/8" UNC Set Screws	●	
C93307016	100	7/16 x 1" UNC Set Screws	●	●
C93307020	100	7/16 x 1-1/4" UNC Set Screws	●	●
C93307024	100	7/16 x 1-1/2" UNC Set Screws	●	●
C93107024	100	7/16 x 1-1/2" UNC Bolts		●
C93107028	100	7/16 x 1-3/4" UNC Bolts		●
C93307032	100	7/16 x 2" UNC Set Screws	●	●
C93107032	100	7/16 x 2" UNC Bolts Only		●
C93107040	100	7/16 x 2-1/2" UNC Bolts		●
C93107048	50	7/16 x 3" UNC Bolts Only		●
C93107056	50	7/16 x 3-1/2" UNC Bolts		●
C93107064	50	7/16 x 4" UNC Bolts Only		●
C93107072	50	7/16 x 4-1/2" UNC Bolts		
C93107080	50	7/16 x 5" UNC Bolts Only		
C93107088	50	7/16 x 5-1/2" UNC Bolts		
C93107096	50	7/16 x 6" UNC Bolts Only		

1/2" UNC

C93308016	50 qty	1/2 x 1" UNC Set Screws	●	●
C93308020	50	1/2 x 1-1/4" UNC Set Screws	●	●
C93308024	50	1/2 x 1-1/2" UNC Set Screws	●	●
C93108024	50	1/2 x 1-1/2" UNC Bolts Only		●
C93308028	50	1/2 x 1-3/4" UNC Set Screws	●	
C93108028	50	1/2 x 1-3/4" UNC Bolts Only		●
C93308032	50	1/2 x 2" UNC Set Screws	●	●
C93108032	50	1/2 x 2" UNC Bolts Only		●
C93108040	50	1/2 x 2-1/2" UNC Bolts Only		●
C93108048	50	1/2 x 3" UNC Bolts Only		●
C93108056	50	1/2 x 3-1/2" UNC Bolts Only		●
C93108064	50	1/2 x 4" UNC Bolts Only		●

5/8" UNC

C93310024	25 qty	5/8 x 1-1/2" UNC Set Screws	●	
C93310028	25	5/8 x 1-3/4" UNC Set Screws	●	
C93110032	25	5/8 x 2" UNC Bolts Only		
C93310040	25	5/8 x 2-1/2" UNC Set Screws	●	
C93110040	25	5/8 x 2-1/2" UNC Bolts Only		
C93110048	25	5/8 x 3" UNC Bolts Only		
C93110056	25	5/8 x 3-1/2" UNC Bolts Only		
C93110064	25	5/8 x 4" UNC Bolts Only		

IMPERIAL, UNC/UNF, HIGH TENSILE GR5, BOLTS & SET SCREWS

GRADE 5, HIGH TENSILE A.S. 2465 – DIN 931 & 933

- FULLY THREADED
- ZINC PLATED



3/4" UNC

C93312024	25 qty	3/4 x 1-1/2" UNC Set Screws	●	
C93312040	25	3/4 x 2-1/2" UNC Set Screws	●	
C93112040	25	3/4 x 2-1/2" UNC Bolts Only		
C93112048	25	3/4 x 3" UNC Bolts Only		

1/4" UNF

F93304008	200 qty	1/4 x 1/2" UNF Set Screws	●	●
F93304010	200	1/4 x 5/8" UNF Set Screws	●	●
F93304012	200	1/4 x 3/4" UNF Set Screws	●	●
F93304016	200	1/4 x 1" UNF Set Screws	●	●
F93304020	200	1/4 x 1-1/4" UNF Set Screws	●	●
F93104020	200	1/4 x 1-1/4" UNF Bolts Only		●
F93304024	200	1/4 x 1-1/2" UNF Set Screws	●	●
F93104024	200	1/4 x 1-1/2" UNF Bolts Only		●
F93304032	200	1/4 x 2" UNF Set Screws	●	●
F93104032	200	1/4 x 2" UNF Bolts Only		●
F93104040	200	1/4 x 2-1/2" UNF Bolts Only		●
F93104048	200	1/4 x 3" UNF Bolts Only		●

5/16" UNF

F93305012	200 qty	5/16 x 3/4" UNF Set Screws	●	●
F93305016	200	5/16 x 1" UNF Set Screws	●	●
F93305020	200	5/16 x 1-1/4" UNF Set Screws	●	●
F93105020	200	5/16 x 1-1/4" UNF Bolts Only		●
F93305024	200	5/16 x 1-1/2" UNF Set Screws	●	●
F93105024	200	5/16 x 1-1/2" UNF Bolts		●
F93105028	200	5/16 x 1-3/4" UNF Bolts		●
F93305032	200	5/16 x 2" UNF Set Screws	●	●
F93105032	200	5/16 x 2" UNF Bolts Only		●
F93105040	200	5/16 x 2-1/2" UNF Bolts		●
F93105048	100	5/16 x 3" UNF Bolts Only		●
F93105056	100	5/16 x 3-1/2" UNF Bolts		●
F93105064	100	5/16 x 4" UNF Bolts Only		●
F93105072	100	5/16 x 4-1/2" UNF Bolts		●
F93105080	100	5/16 x 5" UNF Bolts GR5		●

3/8" UNF

F93306012	100 qty	3/8 x 3/4" UNF Set Screws	●	●
F93306016	100	3/8 x 1" UNF Set Screws	●	●
F93306020	100	3/8 x 1-1/4" UNF Set Screws	●	●
F93306024	100	3/8 x 1-1/2" UNF Set Screws	●	●
F93106024	100	3/8 x 1-1/2" UNF Bolts Only		●
F93106028	100	3/8 x 1-3/4" UNF Bolts Only		●
F93306032	100	3/8 x 2" UNF Set Screws	●	●
F93106032	100	3/8 x 2" UNF Bolts Only		●
F93106040	100	3/8 x 2-1/2" UNF Bolts Only		●
F93306048	50	3/8 x 3" UNF Set Screws	●	
F93106048	50	3/8 x 3" UNF Bolts Only		●
F93106052	50	3/8 x 3-1/4" UNF Bolts Only		●

3/8" UNF *Continued*

F93106056	50 qty	3/8 x 3-1/2" UNF Bolts Only		●
F93106064	50	3/8 x 4" UNF Bolts Only		●
F93106072	50	3/8 x 4-1/2" UNF Bolts Only		
F93106080	50	3/8 x 5" UNF Bolts Only		
F93106088	50	3/8 x 5-1/2" UNF Bolts Only		
F93106096	50	3/8 x 6" UNF Bolts Only		

7/16" UNF

F93307016	100 qty	7/16 x 1" UNF Set Screws	●	●
F93307020	100	7/16 x 1-1/4" UNF Set Screws	●	●
F93307024	100	7/16 x 1-1/2" UNF Set Screws	●	●
F93107024	100	7/16 x 1-1/2" UNF Bolts		●
F93107032	100	7/16 x 2" UNF Bolts Only		●
F93107040	100	7/16 x 2-1/2" UNF Bolts		●
F93107048	50	7/16 x 3" UNF Bolts Only		●
F93107056	50	7/16 x 3-1/2" UNF Bolts		●
F93107064	50	7/16 x 4" UNF Bolts Only		●

1/2" UNF

F93308016	50 qty	1/2 x 1" UNF Set Screws	●	●
F93308020	50	1/2 x 1-1/4" UNF Set Screws	●	●
F93308024	50	1/2 x 1-1/2" UNF Set Screws	●	●
F93108024	50	1/2 x 1-1/2" UNF Bolts Only		●
F93108028	50	1/2 x 1-3/4" UNF Bolts Only		●
F93108032	50	1/2 x 2" UNF Bolts Only		●
F93108036	50	1/2 x 2-1/4" UNF Bolts Only		●
F93108040	50	1/2 x 2-1/2" UNF Bolts Only		●
F93108048	50	1/2 x 3" UNF Bolts Only		●
F93108056	50	1/2 x 3-1/2" UNF Bolts Only		●
F93108064	50	1/2 x 4" UNF Bolts Only		●

5/8" UNF

F93310020	25 qty	5/8 x 1-1/4" UNF Set Screws	●	
F93310024	25	5/8 x 1-1/2" UNF Set Screws	●	
F93310028	25	5/8 x 1-3/4" UNF Set Screws	●	
F93310032	25	5/8 x 2" UNF Set Screws	●	
F93110032	25	5/8 x 2" UNF Bolts Only		
F93310040	25	5/8 x 2-1/2" UNF Set Screws		
F93110056	25	5/8 x 3-1/2" UNF Bolts Only		
F93110064	25	5/8 x 4" UNF Bolts Only		
F93110072	25	5/8 x 4-1/2" UNF Bolts Only		
F93110080	25	5/8 x 5" UNF Bolts Only		
F93110088	25	5/8 x 5-1/2" UNF Bolts Only		
F93110096	25	5/8 x 6" UNF Bolts Only		

3/4" UNF

F93112072	25 qty	3/4 x 4-1/2" UNF Bolts Only		
F93112088	25	3/4 x 5-1/2" UNF Bolts Only		
F93112096	25	3/4 x 6" UNF Bolts Only		
F93112104	25	6-1/2 x 3/4" UNF Bolts GR5		

STANDARD PACKS



IMPERIAL, UNC/UNF, HEX PLAIN NUTS & NYLON LOCK NUTS

HEX PLAIN NUTS UNC/UNF A.S. 2465 – **DIN 934, CLASS 5**



NYLON INSERTED SELF-LOCKING NUTS – **DIN 985**

- PLAIN FINISH ● ZINC PLATED



UNC NUTS

NCN02	200 qty	1/8" UNC 32 TPI Hex Nuts		
NCN03	200	3/16" UNC Hex Nuts	●	
NCN04	200	1/4" UNC Hex Nuts	●	
NCN05	200	5/16" UNC Hex Nuts	●	
NCN06	200	3/8" UNC Hex Nuts	●	
NCN07	200	7/16" UNC Hex Nuts	●	
NCN08	200	1/2" UNC Hex Nuts	●	
NCN09	200	9/16" UNC Hex Nuts	●	
NCN10	200	5/8" UNC Hex Nuts	●	
NCN12	200	3/4" UNC Hex Nuts	●	



UNF NUTS

NFN04	200 qty	1/4" UNF Hex Nuts	●	
NFN05	200	5/16" UNF Hex Nuts	●	
NFN06	200	3/8" UNF Hex Nuts	●	
NFN07	200	7/16" UNF Hex Nuts	●	
NFN08	200	1/2" UNF Hex Nuts	●	
NFN09	200	9/16" UNF Hex Nuts	●	
NFN10	200	5/8" UNF Hex Nuts	●	
NFN12	200	3/4" UNF Hex Nuts	●	

UNC NYLON LOCK NUTS

C98503	200 qty	10/24" UNC Nylon Lock Nuts	●	
C98504	200	1/4" UNC Nylon Lock Nuts	●	
C98505	200	5/16" UNC Nylon Lock Nuts	●	
C98506	200	3/8" UNC Nylon Lock Nuts	●	
C98507	200	7/16" UNC Nylon Lock Nuts	●	
C98508	100	1/2" UNC Nylon Lock Nuts	●	
C98509	100	9/16" UNC Nylon Lock Nuts	●	
C98510	100	5/8" UNC Nylon Lock Nuts	●	
C98512	50	3/4" UNC Nylon Lock Nuts	●	
C98514	50	7/8" UNC Nylon Lock Nuts	●	
C98516	25	1" UNC Nylon Lock Nuts	●	

UNF NYLON LOCK NUTS

F98503	200	10/32" UNF Nylon Lock Nuts	●	
F98504	200	1/4" UNF Nylon Lock Nuts	●	
F98505	200	5/16" UNF Nylon Lock Nuts	●	
F98506	200	3/8" UNF Nylon Lock Nuts	●	
F98507	200	7/16" UNF Nylon Lock Nuts	●	
F98508	100	1/2" UNF Nylon Lock Nuts	●	
F98509	100	9/16" UNF Nylon Lock Nuts	●	
F98510	100	5/8" UNF Nylon Lock Nuts	●	
F98512	50	3/4" UNF Nylon Lock Nuts	●	
F98514	50	7/8" UNF Nylon Lock Nuts	●	
F98516	25	1" UNF Nylon Lock Nuts	●	
F98516-14	25	1"-14 TPI Nylon Lock Nuts	●	





BRASS FITTINGS *Heat Tolerant Corrosion Resistant*





No.100	UNIVERSAL TYPE OLIVE	
C1-02	1/8"	
C1-03	3/16"	
C1-04	1/4"	
C1-05	5/16"	
C1-06	3/8"	
C1-08	1/2"	

No.1	OLIVE (COMPRESSION)	
101	1/8"	
102	3/16"	
103	1/4"	
104	5/16"	
105	3/8"	
107	1/2"	

No.100N	OLIVE (SUIT NYLON TUBE)	
102N	3/16"	
103N	1/4"	
104N	5/16"	
105N	3/8"	
107N	1/2"	

No.2	STANDARD COMPRESSION NUT	
201	1/8"	
202	3/16"	
203	1/4"	
204	5/16"	
205	3/8"	
207	1/2"	

No.3	SINGLE UNION	
301	1/8 x 1/8"	
302	3/16 x 1/8"	
304	1/4 x 1/8"	
305	1/4 x 1/4"	
307	5/16 x 1/8"	
308	5/16 x 1/4"	
311	3/8 x 1/8"	











No.4	DOUBLE UNION	
401	1/8 x 1/8"	
402	3/16 x 3/16"	
403	1/4 x 1/4"	
404	5/16 x 5/16"	
405	3/8 x 3/8"	
406	1/2 x 1/2"	











No.5	SINGLE UNION ELBOW 90°	
502	3/16 x 1/8"	
504	1/4 x 1/8"	
505	1/4 x 1/4"	
507	5/16 x 1/8"	
511	3/8 x 1/8"	
512	3/8 x 1/4"	











No.6	STANDARD FLARE NUT	
603	1/4"	
605	5/16"	









MISC.
FITTINGS

BRASS FITTINGS

No.7	SINGLE FLARE UNION	
706	1/4 x 1/8"	
710	5/16 x 1/8"	
711	5/16 x 1/4"	
715	3/8 x 1/4"	
No.8	FLARE ELBOW 90°	
804	1/4 x 1/8"	
805	1/4 x 1/4"	
812	3/8 x 1/8"	
No.10	FEMALE CONNECTOR	
1004	1/4 x 1/8"	
1008	5/16 x 1/4"	
No.14	'T' UNION	
1403	1/4"	
No.17	DOUBLE FLARE UNION	
1703	1/4 x 1/4"	
1704	5/16 x 5/16"	
No.21	DOLE PATTERN NUT	
2101	1/8"	
2102	3/16"	
2103	1/4"	
2104	5/16"	
No.22	DOLE PATTERN BODY	
2202	3/16 x 1/8"	
2204	1/4 x 1/8"	
2205	5/16 x 1/8"	
No.23	DOLE PATTERN ELBOW	
2302	3/16 x 1/8"	
2303	1/4 x 1/8"	
2304	5/16 x 1/8"	
No.24	REDUCING BUSH BSP	
2401	1/4 x 1/8" BSP	
2402	3/8 x 1/8" BSP	
2403	3/8 x 1/4" BSP	
2404	1/2 x 1/8" BSP	
2405	1/2 x 1/4" BSP	
2406	1/2 x 3/8" BSP	
2409	3/4 x 3/8" BSP	
2410	3/4 x 1/2" BSP	
No.25E	EXTRUDED M & F ELBOW	
2501E	1/8 x 1/8"	
2503E	1/4 x 1/4"	

No.25F	FORGED M&F ELBOW BSP	
2503F	1/4 x 1/4" BSP	
No.26	HEX. SOCKET BSP	
2601	1/8" BSP	
2602	1/4" BSP	
2603	3/8" BSP	
2604	1/2" BSP	
No.27	HEX. NIPPLE BSP	
2701	1/8" BSP	
2702	1/4" BSP	
2703	3/8" BSP	
2704	1/2" BSP	
No.29	HEX. REDUCING SOCKET BSP	
2901	1/4 x 1/8" BSP	
No.30	DRAIN COCK NPT	
3002	1/4" NPT	
No.34	FEMALE ELBOW BSP	
3401	1/8"	
No.35	FEMALE 'T' BSP	
3501	1/8"	
3502	1/4"	
3503	3/8"	
No.44	SOLDER-ON TAIL	
4401	1/8"	
4402	3/16"	
4403	1/4"	
4404	5/16"	
4405	3/8"	
No.45	SOLDER-ON NUT	
4501	1/8"	
4502	3/16"	
4503	1/4"	
4504	5/16"	
4505	3/8"	
No.46	SOLDER-ON SINGLE UNION	
4603	1/8"	
4605	1/8"	

No.47 SOLDER-ON DOUBLE UNION			
4703	1/4"		
4704	5/16"		
			
No.58 INVERTED FLARE NUT (BRASS)			
5802	3/16"		
5803	1/4"		
5804	5/16"		
			
THREADS USED ON INVERTED FLARE - UNF			
TUBE	THREAD	TUBE	THREAD
1/8"	5/16" x 28 TPI	5/16"	1/2" x 20 TPI
3/16"	3/8" x 24 TPI	3/8"	5/8" x 18 TPI
1/4"	7/16" x 24 TPI	1/2"	3/4" x 18 TPI
No.59 INVERTED FLARE ELBOW			
5902	90° INV Elbow		
5903	90° INV Elbow		
5905	90° INV Elbow		
			
No.60 CARBURETTOR NUT			
6001	1/4"		
			
No.62 INVERTED FLARE SINGLE UNION BODY			
6202	3/16 x 1/8"		
6204	5/16 x 1/8"		
			
No.64 HEX. TAPER PLUG BSP			
6401	1/8" BSP		
6402	1/4" BSP		
6403	3/8" BSP		
6404	1/2" BSP		
6405	3/4" BSP		
			
No.71 TANK COLLAR			
7101	1/8 x 1/2"		
			
No.72 M & F ADAPTORS BSP			
7203	1/4 x 1/8"		
7205	3/8 x 1/8"		
7206	3/8 x 1/4"		
			
No.73 REDUCING NIPPLES BSP			
7301	1/4 x 1/8"		
7302	3/8 x 1/8"		
7303	3/8 x 1/4"		
7304	1/2 x 1/4"		
7305	1/2 x 3/8"		
			
No.74 LOCK NUTS BSP			
7401	1/8"		
7402	1/4"		
7403	3/8"		
			

No.P3 MALE TAILPIECE BSP	
P301	3/16 x 1/8" BSP
P302	1/4 x 1/8" BSP
P302A	1/4 x 1/4" BSP
P303	5/16 x 1/8" BSP
P304	3/8 x 1/8" BSP
P305	3/8 x 1/4" BSP
P306	5/16 x 1/4" BSP
P307	1/2 x 1/4" BSP
P308	5/8 x 1/4" BSP
P310	3/8 x 3/8" BSP
P311	1/2 x 3/8" BSP
P312	5/8 x 3/8" BSP
P314	3/8 x 1/2" BSP
P315	1/2 x 1/2" BSP
P316	5/8 x 1/2" BSP
P3-1208	3/8 x 1/2" BSP
P3-1212	3/4 x 3/4" BSP
	
	
	
No.P5 NUT & TAIL	
P501	3/16 x 1/8"
P503	1/4 x 1/8"
P504	1/4 x 1/4"
P505	5/16 x 1/4"
P506	3/8 x 3/8"
	
No.P6 MALE ELBOW BSP	
P601	3/16 x 1/8" BSP
P602	1/4 x 1/8" BSP
P603	5/16 x 1/8" BSP
P604	3/8 x 1/8" BSP
P605	3/8 x 1/4" BSP
P606	5/16 x 1/4" BSP
P607	1/2 x 1/4" BSP
P610	3/8 x 3/8" BSP
P611	1/2 x 3/8" BSP
P612	5/8 x 3/8" BSP
P616	5/8 x 1/2" BSP
	
	
No.P7 HOSE JOINER	
P701	3/16"
P702	1/4"
P703	5/16"
P704	3/8"
P705	1/2"
P706	5/8"
	
No.P14 THREE-WAY 'T'	
P1402	3/16"
P1403	1/4"
P1404	5/16"
P1405	3/8"
P1406	1/2"
P1407	5/8"
	
No.T3 SOLDER-ON LEVER TAP	
T3-0502	5/16 x 1/8"
	

AIR-LINE ACCESSORIES

**HEAVY
DUTY**



HIGHEST QUALITY

200S STEEL & 400S STEEL SERIES BLISTER PACKED



200 SERIES STEEL		
AUTOMATIC COUPLINGS – 1/4" BSP FEMALE		
C200S	1 / pack	1/4"
AUTOMATIC COUPLINGS – 1/4" BSP MALE		
C201S	1 / pack	1/4"
AUTOMATIC COUPLINGS – HOSE BARB		
C240S	1 / pack	5/16"
C241S	1 / pack	3/8"
COUPLING NIPPLE – 1/4" BSP MALE		
C202S	2 / pack	1/4"
COUPLING NIPPLE – 1/4" BSP FEMALE		
C203S	2 / pack	1/4"
COUPLING NIPPLE – HOSE BARB		
C205S	2 / pack	1/4"
C206S	2 / pack	5/16"
C206AS	2 / pack	3/8"

SPECIFICATIONS	200S	400S
Flow Capacity	CFM 45	90
@T BAR/100 PSI	LPM 1300	2500
Max Working Pressure	BAR 20	15
Pressure	PSI 290	220
Temperature Range	-200°C to +800°C -40°F to +1760°C	-200°C to +800°C -40°F to +1760°C

400 SERIES STEEL		
<i>Super-Hi-Flow. Interchange with Nitto.</i>		
AUTOMATIC COUPLINGS – BSP FEMALE		
C420SF	1 / pack	1/4"
C430SF	1 / pack	3/8"
AUTOMATIC COUPLINGS – BSP MALE		
C420SM	1 / pack	1/4"
C430SM	1 / pack	3/8"
AUTOMATIC COUPLINGS – HOSE BARB		
C420SH	1 / pack	1/4"
C425SH	1 / pack	5/16"
C430SH	1 / pack	3/8"
C440SH	1 / pack	1/2"
COUPLING NIPPLES – BSP FEMALE		
C420PF	2 / pack	1/4"
C430PF	2 / pack	3/8"
COUPLING NIPPLE – BSP MALE		
C420PM	2 / pack	1/4"
C430PM	2 / pack	3/8"
COUPLING NIPPLE – HOSE BARB		
C420PH	2 / pack	1/4"
C425PH	2 / pack	5/16"
C430PH	2 / pack	3/8"
C440PH	2 / pack	1/2"

UNIVERSAL FITTINGS		
<i>Popular Adaptors and Accessories</i>		
BRASS HOSE BARB – 1/4" BSP MALE		
C207	2 / pack	1/4"
C208	2 / pack	5/16"
C209	2 / pack	3/8"
BRASS HOSE BARB – 1/4" BSP FEMALE		
C236	2 / pack	1/4"
C237	2 / pack	5/16"
C238	2 / pack	3/8"
BRASS HOSE BARB – JOINER		
C227	2 / pack	1/4"
C228	2 / pack	5/16"
C229	2 / pack	3/8"
BLOW GUNS – 1/4" BSP FEMALE		
C223	1 / pack	1/4" BSP
COUPLING NIPPLE – HOSE BARB		
C205S	2 / pack	1/4"
C206S	2 / pack	5/16"
C206AS	2 / pack	3/8"
MALE COUPLING		FEMALE COUPLING
		HOSE BARB COUPLING

MISC. FITTINGS

AIR-LINE FITTINGS BOXED

- Shelf or counter display
- Quantity of 10 per box
- An economic way to display your most popular Champion Air-Line Fittings



NITTO INTERCHANGE



Box of 10

B420MC-10 1/4" MALE COUPLING



Box of 10

B420FN-10 1/4" FEMALE NIPPLE



Box of 10

B420FC-10 1/4" FEMALE COUPLING



Box of 10

B425H-10 5/16" HOSE BARB NIPPLE



Box of 10

B430HC-10 3/8" HOSE BARB COUPLING



Box of 10

B430H-10 3/8" HOSE BARB NIPPLE



Box of 10

B420MN-10 1/4" MALE NIPPLE



Box of 10

B440H-10 1/2" HOSE BARB NIPPLE

RYCO INTERCHANGE



Box of 10

B201-10 1/4" MALE COUPLING



Box of 10

B202-10 1/4" MALE NIPPLE



Box of 10

B203-10 1/4" FEMALE NIPPLE



Box of 10

B200-10 1/4" FEMALE COUPLING



Box of 10

B206-10 5/16" HOSE BARB NIPPLE



Box of 10

B208-10 3/8" HOSE BARB NIPPLE



Box of 10

B241-10 3/8" HOSE BARB COUPLING

MISC.
FITTINGS

JAMEC INTERCHANGE



Box of 10

B310M-10 1/4" MALE COUPLING



Box of 10

B310F-10 1/4" FEMALE COUPLING



Box of 10

B310T-10 3/8" HOSE BARB COUPLING



Box of 10

B31M-10 1/4" MALE NIPPLE



Box of 10

B31F-10 1/4" FEMALE NIPPLE



Box of 10

B315B-10 5/16" HOSE BARB NIPPLE



Box of 10

B316B-10 3/8" HOSE BARB NIPPLE

UNIVERSAL



Box of 10

B207B-10 1/4" HOSE BARB x 1/4" MALE



Box of 10

B208B-10 5/16" HOSE BARB x 1/4" MALE



Box of 10

B209B-10 3/8" HOSE BARB x 1/4" MALE



Box of 10

B238-10 3/8" HOSE BARB x 1/4" FEMALE



Box of 10

B2702-10 1/4" x 1/4" MALE ADAPTOR

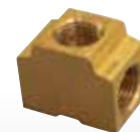

Box of 10

B3502-10 1/4" 3 WAY FEMALE 'T'



Box of 10

B2403-10 3/8" to 1/4" FEMALE REDUCER



Box of 10

BTC4-10 1/4" FEMALE TYRE CHUCK

MISC. FITTINGS

STAINLESS STEEL AIR COUPLINGS

A comprehensive range of Stainless Steel Couplings and Fittings. Interchangeable with NITTO systems.



Stainless Steel

CSM20SS 1/4" MALE COUPLING



Stainless Steel

CSH30SS 3/8" HOSE BARB COUPLING



Stainless Steel

CFS20SS 1/4" FEMALE COUPLING



Stainless Steel

CSH40SS 1/2" HOSE BARB COUPLING



Stainless Steel

CPM20SS 1/4" MALE NIPPLE



Stainless Steel

CPH30SS 3/8" HOSE BARB NIPPLE



Stainless Steel

CPF20SS 1/4" FEMALE NIPPLE



Stainless Steel

CPH40SS 1/2" HOSE BARB NIPPLE



CSW-02 UNIVERSAL SWIVEL JOINT

• 1/4" Male/Female

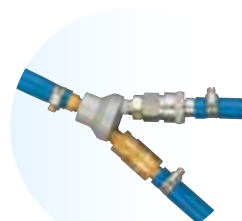
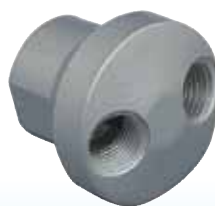

CSMY-2 AIR MANIFOLD 1 IN 2 OUT

• 1/4" Female



CLN-02B IN-LINE AIR REGULATOR

• 1/4" Male/Female

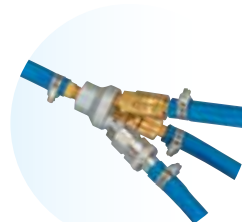

CSMY-3 AIR MANIFOLD 1 IN 3 OUT

• 1/4" Female



CLF-07 IN-LINE WATER SEPARATOR

• 1/4" Male/Female

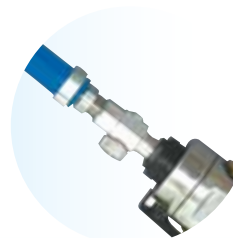

CAR-02 IN-LINE AIR TAP

• 1/4" Male/Female



CMF-20 SWIVEL JOINT

• 1/4" Male/Female



CPM-20 SWIVEL JOINT

• 1/4" Male/Nipple (Nitro Interchange)

MISC.
FITTINGS

VALVES, MANIFOLDS & JOINTS



CAY-1010 IN-LINE AIR CONTROL UNIT

- Filter, regulator, lubricator and gauge
- Gauge: kPa, PSI
- Wall mounted water trap



BREG02 IN-LINE REGULATOR

- Body: Cast aluminium
- Gauge: kPa, PSI



CSV-02 BLOW OFF VALVE

- 1/4" Male
- 150 PSI



CAH10-20 AIR HOSE

- 20 metres
- 10mm (3/8")



CLV-02A MINI OILER

- 1/4" Male/Female



CAH8-20 AIR HOSE

- 20 metres
- 8mm (5/16")

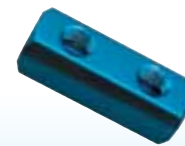

BMP2-10 2 WAY MANIFOLD 1/4"

- 2 way manifold 1/4"
- Box of 10



CTR003 3 PIECE NOZZLE SET

- Rubber tip
- Silencer tip
- Safety tip

MISC.
FITTINGS



*with Deflator Button
0-150 PSI, 0-1050 KPA.
Magnified Sight Glass.
Dual Calibrated.*

CHP150 DUAL CHUCK TYRE INFLATOR

- Heavy duty aluminium die cast body
- Spiral protected air hose
- Dual hold-on chuck
- Rubber hose protector
- Impact absorbing bumpers



CAR003 3 PIECE DELUXE BLOW GUN

- Nitto interchange
- Standard nozzle
- 110mm nozzle
- Die cast
- Aluminium body



CAR004 DELUXE AIR BLOWER

- Strong ABS body
- 100mm angled nozzle
- Internal brass thread 1/4" BSP
- Working pressure 90-120 PSI



CAR008 8 PIECE DELUXE AIR GUN KIT

- 3" nylon tip, air screen tip, adjustable tip, safety booster tip, safety tip, rubber tip, standard safety tip, 2 way air intake.



*Extends from
310mm to 525mm*

CAR009T DELUXE TELESCOPIC AIR GUN

- Extends from 310mm to 525mm
- Die cast aluminium body
- Nitto interchange
- Two way air intake

MISC.
FITTINGS

MERCHANDISERS

*One of the largest selections of merchandisers available.
Suited to all types of retail and trade outlets. Including; Auto, Marine,
Hardware and Industrial.*



- Unique, space saving design, allowing the display of more product in limited areas
- All merchandisers include barcoded back labels for quick identification and re-ordering
- Colour coordinated, eye-catching display units contain a selection of the most popular products
- Crystal clear packaging allows for easy identification of the products before purchase
- All products are supplied in tamper-proof, reusable, recyclable clamshells or blister carded packs



HIGH TENSILE BOLTS & NUTS Part No. BN254



Handy Thread Tester Panel included with merchandiser for accurate identification

Also available seperately. Refer p218

BN254 HIGH TENSILE BOLT & NUT MERCHANDISER

Merchandiser includes a comprehensive range of:

- High Tensile Bolts & Nuts
- Flange Head Nuts & Bolts
- Nylon Insert Lock Nuts
- Socket Head Screws

(suitable for automotive, industrial and hardware outlets)

Includes:

- 3 x 252 types of High Tensile Bolts & Nuts
- Total of 756 Packs
- Metric, UNC and UNF threads included in the range
- Time saving thread tester is incorporated into stand
- Individual panels may be wall mounted
- Merchandiser dimensions: 680mm x 1720mm (incl. header)

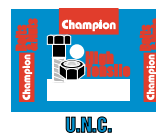

COLOUR CODED PACKS

Packaged in reusable plastic clam shells and colour coded by thread type.

- Blue: U.N.C
- Red: U.N.F
- Yellow: Metric

THREAD TESTER PANEL

The BN254 merchandiser incorportes a unique thread tester panel which enables accurate identification of thread type, diameter, pitch and length for both bolts and nuts.

METRIC THREAD

GRADE 8.8 HIGH TENSILE BOLTS, SET SCREWS & NUTS

BM12	5 x 16mm	Set Screws & Nuts
BM13	5 x 20mm	Set Screws & Nuts
BM14	5 x 25mm	Set Screws & Nuts
BM15	5 x 30mm	Set Screws & Nuts
BM18	5 x 50mm	Set Screws & Nuts
BM21	6 x 16mm	Set Screws & Nuts
BM22	6 x 20mm	Set Screws & Nuts
BM23	6 x 25mm	Set Screws & Nuts
BM25	6 x 30mm	Set Screws & Nuts
BM26	6 x 35mm	Set Screws & Nuts
BM27	6 x 40mm	Set Screws & Nuts
BM29	6 x 50mm	Bolts & Nuts
BM30	6 x 50mm	Set Screws & Nuts
BM32	6 x 60mm	Bolts & Nuts
BM34	6 x 70mm	Bolts & Nuts
BM35	6 x 80mm	Bolts & Nuts
BM37	6 x 100mm	Bolts & Nuts
BM40	7 x 35mm	Set Screws & Nuts
BM45	8 x 16mm	Set Screws & Nuts
BM47	8 x 20mm	Set Screws & Nuts
BM48	8 x 25mm	Set Screws & Nuts
BM51	8 x 30mm	Set Screws & Nuts
BM52	8 x 35mm	Set Screws & Nuts
BM55	8 x 40mm	Set Screws & Nuts
BM57	8 x 50mm	Bolts & Nuts
BM58	8 x 50mm	Set Screws & Nuts
BM60	8 x 60mm	Bolts & Nuts
BM63	8 x 65mm	Bolts & Nuts
BM65	8 x 75mm	Bolts & Nuts
BM67	8 x 80mm	Bolts & Nuts
BM69	8 x 100mm	Bolts & Nuts
BM70	8 x 100mm	Set Screws & Nuts
BM74	8 x 35 x 1.00mm	Set Screws & Nuts
BM77	8 x 50 x 1.00mm	Bolts & Nuts
BM79	10 x 25mm	Set Screws & Nuts
BM83	10 x 35mm	Set Screws & Nuts
BM84	10 x 40mm	Set Screws & Nuts
BM86	10 x 45mm	Bolts & Nuts
BM87	10 x 50mm	Bolts & Nuts
BM88	10 x 50mm	Set Screws & Nuts
BM89	10 x 60mm	Bolts & Nuts
BM91	10 x 65mm	Bolts & Nuts
BM93	10 x 70mm	Bolts & Nuts
BM95	10 x 75mm	Set Screws & Nuts
BM96	10 x 80mm	Bolts & Nuts
BM98	10 x 100mm	Bolts & Nuts
BM99	10 x 100mm	Set Screws & Nuts
BM102	10 x 35 x 1.00mm	Set Screws & Nuts
BM104	10 x 25 x 1.25mm	Set Screws & Nuts
BM106	10 x 35 x 1.25mm	Set Screws & Nuts
BM109	10 x 45 x 1.25mm	Set Screws & Nuts
BM110	10 x 50 x 1.25mm	Set Screws & Nuts
BM112	10 x 70 x 1.25mm	Bolts & Nuts
BM116	12 x 30mm	Set Screws & Nuts
BM120	12 x 40mm	Set Screws & Nuts
BM123	12 x 45mm	Set Screws & Nuts
BM124	12 x 50mm	Set Screws & Nuts
BM125	12 x 50mm	Bolts & Nuts
BM126	12 x 60mm	Bolts & Nuts
BM128	12 x 65mm	Bolts & Nuts
BM131	12 x 70mm	Bolts & Nuts
BM133	12 x 80mm	Bolts & Nuts
BM134	12 x 90mm	Bolts & Nuts
BM135	12 x 100mm	Bolts & Nuts
BM136	12 x 100mm	Set Screws & Nuts
BM140	12 x 1.5 x 35mm	Set Screws & Nuts

METRIC THREAD *Continued*

GRADE 8.8 HIGH TENSILE BOLTS, SET SCREWS & NUTS

BM142	M12 x 1.5 x 40mm	Bolts & Nuts
BM144	M12 x 1.5 x 50mm	Bolts & Nuts
BM145	M12 x 1.5 x 50mm	Set Screws & Nuts
BM147	M12 x 1.5 x 60mm	Bolts & Nuts
BM148	M12 x 1.5 x 75mm	Bolts & Nuts
BM150	M12 x 1.25 x 35mm	Set Screws & Nuts
BM152	M12 x 1.25 x 50mm	Set Screws & Nuts
BM154	M12 x 1.25 x 75mm	Bolts & Nuts
BM157	M5 x 0.8	Hexagon Nuts
BM159	M6 x 1.00	Hexagon Nuts
BM161	M8 x 1.25	Hexagon Nuts
BM162	M8 x 1.00	Hexagon Nuts
BM163	M10 x 1.50	Hexagon Nuts
BM164	M10 x 1.25	Hexagon Nuts
BM165	M10 x 1.00	Hexagon Nuts
BM166	M12 x 1.75	Hexagon Nuts
BM167	M12 x 1.5	Hexagon Nuts
BM168	M12 x 1.25	Hexagon Nuts

FLANGE HEAD

FBM12	5 x 16mm	Flange Bolts
FBM14	5 x 25mm	Flange Bolts
FBM21	6 x 16mm	Flange Bolts
FBM22	6 x 20mm	Flange Bolts
FBM23	6 x 25mm	Flange Bolts
FBM25	6 x 30mm	Flange Bolts
FBM27	6 x 40mm	Flange Bolts
FBM45	8 x 16mm	Flange Bolts
FBM47	8 x 20mm	Flange Bolts
FBM48	8 x 25mm	Flange Bolts
FBM51	8 x 30mm	Flange Bolts
FBM55	8 x 40mm	Flange Bolts
FBM57	8 x 50mm	Flange Bolts
FBM104	10 x 25 x 1.25mm	Flange Bolts
FBM106	10 x 35 x 1.25mm	Flange Bolts
FBM107	10 x 40 x 1.25mm	Flange Bolts
FBM110	10 x 50 x 1.25mm	Flange Bolts
FBM157	M5 x 0.8	Flange Nuts
FBM159	M6 x 1.00	Flange Nuts
FBM161	M8 x 1.25	Flange Nuts
FBM164	M10 x 1.25	Flange Nuts

NYLON INSERT LOCK NUTS

SLM157	M5 x 0.8	Nylon Insert Lock Nuts
SLM158	M6 x 1.00	Nylon Insert Lock Nuts
SLM160	M7 x 1.00	Nylon Insert Lock Nuts
SLM161	M8 x 1.25	Nylon Insert Lock Nuts
SLM162	M8 x 1.00	Nylon Insert Lock Nuts
SLM163	M10 x 1.5	Nylon Insert Lock Nuts
SLM164	M10 x 1.25	Nylon Insert Lock Nuts
SLM165	M10 x 1.00	Nylon Insert Lock Nuts
SLM166	M12 x 1.75	Nylon Insert Lock Nuts
SLM167	M12 x 1.5	Nylon Insert Lock Nuts
SLM168	M12 x 1.25	Nylon Insert Lock Nuts

SOCKET HEAD SCREWS

SHM21	M6 x 16	Socket Head Screws
SHM22	M6 x 20	Socket Head Screws
SHM23	M6 x 25	Socket Head Screws
SHM25	M6 x 30	Socket Head Screws
SHM27	M6 x 40	Socket Head Screws
SHM30	M6 x 50	Socket Head Screws
SHM34	M6 x 70	Socket Head Screws
SHM35	M6 x 80	Socket Head Screws
SHM45	M8 x 16	Socket Head Screws
SHM48	M8 x 25	Socket Head Screws

UNF THREAD		
GRADE 5 HIGH TENSILE BOLTS, SET SCREWS & NUTS		
BF1	1/4 x 1/2"	Set Screws & Nuts
BF3	1/4 x 3/4"	Set Screws & Nuts
BF4	1/4 x 1"	Set Screws & Nuts
BF7	1/4 x 1-1/4"	Bolts & Nuts
BF8	1/4 x 1-1/2"	Set Screws & Nuts
BF9	1/4 x 1-1/2"	Bolts & Nuts
BF11	1/4 x 2"	Set Screws & Nuts
BF12	1/4 x 2"	Bolts & Nuts
BF13	1/4 x 2-1/2"	Bolts & Nuts
BF14	1/4 x 3"	Bolts & Nuts
BF15	5/16 x 3/4"	Set Screws & Nuts
BF17	5/16 x 1"	Set Screws & Nuts
BF19	5/16 x 1-1/4"	Set Screws & Nuts
BF20	5/16 x 1-1/2"	Bolts & Nuts
BF21	5/16 x 1-1/2"	Set Screws & Nuts
BF23	5/16 x 2"	Bolts & Nuts
BF26	5/16 x 2-1/2"	Bolts & Nuts
BF28	5/16 x 3"	Bolts & Nuts
BF29	5/16 x 3-1/2"	Bolts & Nuts
BF30	5/16 x 4"	Bolts & Nuts
BF31	3/8 x 3/4"	Set Screws & Nuts
BF33	3/8 x 1"	Set Screws & Nuts
BF34	3/8 x 1-1/4"	Set Screws & Nuts
BF36	3/8 x 1-1/2"	Set Screws & Nuts
BF37	3/8 x 1-1/2"	Bolts & Nuts
BF38	3/8 x 1-3/4"	Bolts & Nuts
BF39	3/8 x 2"	Bolts & Nuts
BF40	3/8 x 2"	Set Screws & Nuts
BF42	3/8 x 2-1/2"	Bolts & Nuts
BF43	3/8 x 3"	Bolts & Nuts
BF45	3/8 x 3-1/2"	Bolts & Nuts
BF47	3/8 x 4"	Bolts & Nuts
BF50	7/16 x 1"	Set Screws & Nuts
BF52	7/16 x 1-1/4"	Set Screws & Nuts
BF54	7/16 x 1-1/2"	Set Screws & Nuts
BF55	7/16 x 1-1/2"	Bolts & Nuts
BF57	7/16 x 2"	Bolts & Nuts
BF58	7/16 x 2-1/2"	Bolts & Nuts
BF59	7/16 x 3"	Bolts & Nuts
BF60	7/16 x 3-1/2"	Bolts & Nuts
BF62	1/2 x 1"	Set Screws & Nuts
BF63	1/2 x 1-1/4"	Set Screws & Nuts
BF65	1/2 x 1-1/2"	Bolts & Nuts
BF66	1/2 x 1-1/2"	Set Screws & Nuts
BF68	1/2 x 1-3/4"	Bolts & Nuts
BF69	1/2 x 2"	Bolts & Nuts
BF72	1/2 x 2-1/2"	Bolts & Nuts
BF74	1/2 x 3"	Bolts & Nuts
BF75	1/2 x 3-1/2"	Bolts & Nuts
BF77	1/4"	Hexagon Nuts
BF78	5/16"	Hexagon Nuts
BF79	3/8"	Hexagon Nuts
BF80	7/16"	Hexagon Nuts
BF81	1/2"	Hexagon Nuts
NYLON INSERT LOCK NUTS		
SLF77	1/4"	Nylon Insert Lock Nuts
SLF78	5/16"	Nylon Insert Lock Nuts
SLF79	3/8"	Nylon Insert Lock Nuts
SLF80	7/16"	Nylon Insert Lock Nuts
SLF81	1/2"	Nylon Insert Lock Nuts
UNC THREAD		
GRADE 5 HIGH TENSILE BOLTS, SET SCREWS & NUTS		
SHC3	1/4 x 3/4"	Socket Head Screws
SHC15	5/16 x 3/4"	Socket Head Screws
SHC17	5/16 x 1"	Socket Head Screws
SHC19	5/16 x 1-1/4"	Socket Head Screws

UNC THREAD <i>Continued</i>		
GRADE 5 HIGH TENSILE BOLTS, SET SCREWS & NUTS		
BC1	1/4 x 1/2"	Set Screws & Nuts
BC3	1/4 x 3/4"	Set Screws & Nuts
BC4	1/4 x 1"	Set Screws & Nuts
BC6	1/4 x 1-1/4"	Set Screws & Nuts
BC8	1/4 x 1-1/2"	Set Screws & Nuts
BC9	1/4 x 1-1/2"	Bolts & Nuts
BC11	1/4 x 2"	Set Screws & Nuts
BC12	1/4 x 2"	Bolts & Nuts
BC13	1/4 x 2-1/2"	Bolts & Nuts
BC14	1/4 x 3"	Bolts & Nuts
BC15	5/16 x 3/4"	Set Screws & Nuts
BC17	5/16 x 1"	Set Screws & Nuts
BC19	5/16 x 1-1/4"	Set Screws & Nuts
BC20	5/16 x 1-1/2"	Bolts & Nuts
BC21	5/16 x 1-1/2"	Set Screws & Nuts
BC23	5/16 x 2"	Bolts & Nuts
BC26	5/16 x 2-1/2"	Bolts & Nuts
BC28	5/16 x 3"	Bolts & Nuts
BC29	5/16 x 3-1/2"	Bolts & Nuts
BC30	5/16 x 4"	Bolts & Nuts
BC31	3/8 x 3/4"	Set Screws & Nuts
BC33	3/8 x 1"	Set Screws & Nuts
BC34	3/8 x 1-1/4"	Bolts & Nuts
BC36	3/8 x 1-1/2"	Set Screws & Nuts
BC37	3/8 x 1-1/2"	Bolts & Nuts
BC38	3/8 x 1-3/4"	Bolts & Nuts
BC39	3/8 x 2"	Bolts & Nuts
BC40	3/8 x 2"	Set Screws & Nuts
BC42	3/8 x 2-1/2"	Bolts & Nuts
BC43	3/8 x 3"	Bolts & Nuts
BC44	3/8 x 3"	Set Screws & Nuts
BC45	3/8 x 3-1/2"	Bolts & Nuts
BC47	3/8 x 4"	Bolts & Nuts
BC50	7/16 x 1"	Set Screws & Nuts
BC52	7/16 x 1-1/4"	Set Screws & Nuts
BC54	7/16 x 1-1/2"	Set Screws & Nuts
BC55	7/16 x 1-1/2"	Bolts & Nuts
BC57	7/16 x 2"	Bolts & Nuts
BC58	7/16 x 2-1/2"	Bolts & Nuts
BC59	7/16 x 3"	Bolts & Nuts
BC60	7/16 x 3-1/2"	Bolts & Nuts
BC61	7/16 x 4"	Bolts & Nuts
BC62	1/2 x 1"	Set Screws & Nuts
BC63	1/2 x 1-1/4"	Set Screws & Nuts
BC65	1/2 x 1-1/2"	Bolts & Nuts
BC66	1/2 x 1-1/2"	Set Screws & Nuts
BC68	1/2 x 1-3/4"	Bolts & Nuts
BC69	1/2 x 2"	Bolts & Nuts
BC70	1/2 x 2"	Set Screws & Nuts
BC72	1/2 x 2-1/2"	Bolts & Nuts
BC74	1/2 x 3"	Bolts & Nuts
BC75	1/2 x 3-1/2"	Bolts & Nuts
BC76	1/2 x 4"	Bolts & Nuts
BC77	1/4"	Hexagon Nuts
BC78	5/16"	Hexagon Nuts
BC79	3/8"	Hexagon Nuts
BC80	7/16"	Hexagon Nuts
BC81	1/2"	Hexagon Nuts
NYLON INSERT LOCK NUTS		
SLC77	1/4"	Nylon Insert Lock Nuts
SLC78	5/16"	Nylon Insert Lock Nuts
SLC79	3/8"	Nylon Insert Lock Nuts
SLC80	7/16"	Nylon Insert Lock Nuts
SLC81	1/2"	Nylon Insert Lock Nuts

MERCHANTISERS



BN2

WALL MOUNTED FLANGE BOLTS & NUTS MERCHANDISER

Wall mountable merchandiser with a selection of:

- High Tensile Flange Bolts & Nuts
- Nylon Insert Self-Locking Nuts
- Socket Head Cap Screws

Includes:

- 3 x 56 types of High Tensile Bolts & Nuts
- Total of 168 Packs
- Packed in reusable clamshells, barcoded and colour coded by thread type
- Merchandiser Dimensions: 440mm x 1200mm (incl. header)

Champion
FASTENERS

WALL MOUNTED FLANGE BOLTS & NUTS

Part No. **BN2**

MERCHANDISER CONTENTS (56 TYPES)

HIGH TENSILE BOLTS & NUTS

FBM12	5 x 16mm	Flange Bolts
FBM14	5 x 25mm	Flange Bolts
FBM21	6 x 16mm	Flange Bolts
FBM22	6 x 20mm	Flange Bolts
FBM23	6 x 25mm	Flange Bolts
FBM25	6 x 30mm	Flange Bolts
FBM27	6 x 40mm	Flange Bolts
FBM45	8 x 16mm	Flange Bolts
FBM47	8 x 20mm	Flange Bolts
FBM48	8 x 25mm	Flange Bolts
FBM51	8 x 30mm	Flange Bolts
FBM55	8 x 40mm	Flange Bolts
FBM57	8 x 50mm	Flange Bolts
FBM104	10 x 25 x 1.25mm	Flange Bolts
FBM106	10 x 35 x 1.25mm	Flange Bolts
FBM107	10 x 40 x 1.25mm	Flange Bolts
FBM110	10 x 50 x 1.25mm	Flange Bolts
FBM157	M5 x 0.8	Flange Nuts
FBM159	M6 x 1.00	Flange Nuts
FBM161	M8 x 1.25	Flange Nuts
FBM164	M10 x 1.25	Flange Nuts
SLC77	UNC 1/4"	Nylon Insert Locking Nuts
SLC78	UNC 5/16"	Nylon Insert Locking Nuts
SLC79	UNC 3/8"	Nylon Insert Locking Nuts
SLC80	UNC 7/16"	Nylon Insert Locking Nuts
SLC81	UNC 1/2"	Nylon Insert Locking Nuts
SLF77	UNF 1/4"	Nylon Insert Locking Nuts
SLF78	UNF 5/16"	Nylon Insert Locking Nuts
SLF79	UNF 3/8"	Nylon Insert Locking Nuts
SLF80	UNF 7/16"	Nylon Insert Locking Nuts
SLF81	UNF 1/2"	Nylon Insert Locking Nuts
SLM157	M5 x 0.8	Nylon Insert Locking Nuts
SLM158	M6 x 1.00	Nylon Insert Locking Nuts
SLM160	M7 x 1.00	Nylon Insert Locking Nuts
SLM161	M8 x 1.25	Nylon Insert Locking Nuts
SLM162	M8 x 1.00	Nylon Insert Locking Nuts
SLM163	M10 x 1.5	Nylon Insert Locking Nuts
SLM164	M10 x 1.25	Nylon Insert Locking Nuts
SLM165	M10 x 1.00	Nylon Insert Locking Nuts
SLM166	M12 x 1.75	Nylon Insert Locking Nuts
SLM167	M12 x 1.5	Nylon Insert Locking Nuts
SLM168	M12 x 1.25	Nylon Insert Locking Nuts
SHC3	1/4 x 3/4"	Socket Head Screws
SHC15	5/16 x 3/4"	Socket Head Screws
SHC17	5/16 x 1"	Socket Head Screws
SHC19	5/16 x 1-1/4"	Socket Head Screws
SHM21	M6 x 16	Socket Head Screws
SHM22	M6 x 20	Socket Head Screws
SHM23	M6 x 25	Socket Head Screws
SHM25	M6 x 30	Socket Head Screws
SHM27	M6 x 40	Socket Head Screws
SHM30	M6 x 50	Socket Head Screws
SHM34	M6 x 70	Socket Head Screws
SHM35	M6 x 80	Socket Head Screws
SHM45	M8 x 16	Socket Head Screws
SHM48	M8 x 25	Socket Head Screws



BN56

WALL MOUNTED BOLTS & NUTS MERCHANDISER

Wall mountable merchandiser with a selection of popular products:

- High Tensile Metric, UNF & UNC Nuts & Bolts

Includes:

- 3 x 56 types of High Tensile Bolts & Nuts
- Total of 168 Packs
- Packed in reusable clamshells, barcoded and colour coded by thread type
- Merchandiser Dimensions: 440mm x 990mm (incl. header)

Champion
FASTENERS

WALL MOUNTED BOLTS & NUTS

Part No. **BN56**

MERCHANDISER CONTENTS (56 TYPES)

HIGH TENSILE BOLTS & NUTS

BC1	1/4 x 1/2" UNC	Set Screws & Nuts
BC3	1/4 x 3/4" UNC	Set Screws & Nuts
BC4	1/4 x 1" UNC	Set Screws & Nuts
BC15	5/16 x 3/4" UNC	Set Screws & Nuts
BC17	5/16 x 1" UNC	Set Screws & Nuts
BC19	5/16 x 1-1/4" UNC	Set Screws & Nuts
BC21	5/16 x 1-1/2" UNC	Set Screws & Nuts
BC33	3/8 x 1" UNC	Set Screws & Nuts
BC34	3/8 x 1-1/4" UNC	Set Screws & Nuts
BC36	3/8 x 1-1/2" UNC	Set Screws & Nuts
BF1	1/4 x 1/2" UNF	Set Screws & Nuts
BF3	1/4 x 3/4" UNF	Set Screws & Nuts
BF4	1/4 x 1" UNF	Set Screws & Nuts
BF15	5/16 x 3/4" UNF	Set Screws & Nuts
BF17	5/16 x 1" UNF	Set Screws & Nuts
BF19	5/16 x 1-1/4" UNF	Set Screws & Nuts
BM12	M5 x 16mm	Set Screws & Nuts
BM13	M5 x 20mm	Set Screws & Nuts
BM14	M5 x 25mm	Set Screws & Nuts
BM15	M5 x 30mm	Set Screws & Nuts
BM18	M5 x 50mm	Set Screws & Nuts
BM21	M6 x 16mm	Set Screws & Nuts
BM22	M6 x 20mm	Set Screws & Nuts
BM23	M6 x 25mm	Set Screws & Nuts
BM25	M6 x 30mm	Set Screws & Nuts
BM26	M6 x 35mm	Set Screws & Nuts
BM27	M6 x 40mm	Set Screws & Nuts
BM30	M6 x 50mm	Set Screws & Nuts
BM32	M6 x 60mm	Bolts & Nuts
BM34	M6 x 70mm	Bolts & Nuts
BM35	M6 x 80mm	Bolts & Nuts
BM40	M7 x 35mm	Set Screws & Nuts
BM45	M8 x 16mm	Set Screws & Nuts
BM47	M8 x 20mm	Set Screws & Nuts
BM48	M8 x 25mm	Set Screws & Nuts
BM51	M8 x 30mm	Set Screws & Nuts
BM52	M8 x 35mm	Set Screws & Nuts
BM55	M8 x 40mm	Set Screws & Nuts
BM57	M8 x 50mm	Bolts & Nuts
BM58	M8 x 50mm	Set Screws & Nuts
BM60	M8 x 60mm	Bolts & Nuts
BM65	M8 x 75mm	Bolts & Nuts
BM70	M8 x 100mm	Set Screws & Nuts
BM79	M10 x 25mm	Set Screws & Nuts
BM83	M10 x 35mm	Set Screws & Nuts
BM84	M10 x 40mm	Set Screws & Nuts
BM88	M10 x 50mm	Set Screws & Nuts
BM99	M10 x 100mm	Set Screws & Nuts
BM102	M10 x 1.0 x 35mm	Set Screws & Nuts
BM104	M10 x 1.25 x 25mm	Set Screws & Nuts
BM106	M10 x 1.25 x 35mm	Set Screws & Nuts
BM109	M10 x 1.25 x 45mm	Set Screws & Nuts
BM110	M10 x 1.25 x 50mm	Set Screws & Nuts
BM112	M10 x 1.25 x 70mm	Bolts & Nuts
BM150	M12 x 1.25 x 35mm	Set Screws & Nuts
BM152	M12 x 1.25 x 50mm	Set Screws & Nuts



CVH1

VACUUM HOSE & TUBE CONNECTORS

This wall merchandiser carries a popular selection of vacuum and fuel hose fittings. All packaged in reusable blisters, designed to be sold at one price.

These fittings are ideal for automotive and industrial use. They are fuel compatible with connectors, manufactured from acetal resin and feature tapered thread fittings made from polyimide 6.

- 2 & 3 Way Barb Fittings
- Hex Plugs
- 'Y' Barbs
- 'T' Barbs
- Straight Barbs
- Male Hose Tails
- Vacuum Caps

Champion
FASTENERS

VACUUM HOSE & TUBE CONNECTORS

Part No. **CVH1**

Includes:

- 3 x 49 types of Vacuum Connector Packs
- Total of 147 packs
- Merchandiser Dimensions: 400mm x 1100mm (incl. header board)

MERCHANDISER CONTENTS (49 TYPES)

CVC1	3mm	'T' Piece
CVC2	5mm	'T' Piece
CVC3	6mm	'T' Piece
CVC4	8mm	'T' Piece
CVC5	10mm	'T' Piece
CVC6	3mm	90° Elbows
CVC7	5mm	90° Elbows
CVC8	6mm	90° Elbows
CVC9	8mm	90° Elbows
CVC10	10mm	90° Elbows
CVC11	3mm - 4mm - 3mm	Reducing 'T' Piece
CVC12	4mm - 6mm - 4mm	Reducing 'T' Piece
CVC13	6mm - 4mm - 6mm	Reducing 'T' Piece
CVC14	8mm - 4mm - 8mm	Reducing 'T' Piece
CVC15	8mm - 6mm - 8mm	Reducing 'T' Piece
CVC16	10mm - 6mm - 10mm	Reducing 'T' Piece
CVC17	3mm	Straight Connectors
CVC18	5mm	Straight Connectors
CVC19	6mm	Straight Connectors
CVC20	8mm	Straight Connectors
CVC21	10mm	Straight Connectors
CVC22	4mm - 3mm	Reducing Straight Connectors
CVC23	6mm - 4mm	Reducing Straight Connectors
CVC24	8mm - 6mm	Reducing Straight Connectors
CVC25	10mm - 6mm	Reducing Straight Connectors
CVC26	10mm - 8mm	Reducing Straight Connectors
CVC27	5mm	4 Way 'X' Piece
CVC28	Piece 6mm	4 Way 'X' Piece
CVC29	3mm	3 Way 'Y' Piece
CVC30	5mm	3 Way 'Y' Piece
CVC31	6mm	3 Way 'Y' Piece
CVC32	8mm	3 Way 'Y' Piece
CVC33	10mm	3 Way 'Y' Piece
CVC34	6mm - 8mm - 6mm	Reducing "Y" Piece
CVC35	4mm x 1/4" BSP	Tailpiece
CVC36	5mm x 1/4" BS	Tailpiece
CVC37	6mm x 1/4" BSP	Tailpiece
CVC38	8mm x 1/4" BSP	Tailpiece
CVC39	6mm x 1/4" BSP	Elbows
CVC40	8mm x 1/4" BSP	Elbows
CVC41	1/8" BSP	Hex Taper Plugs
CVC42	1/4" BSP	Hex Taper Plugs
CVC43	3/8" BSP	Hex Taper Plugs
CVC44	3mm	Caps
CVC45	4mm	Caps
CVC46	5mm	Caps
CVC47	6mm	Caps
CVC48	8mm	Caps
CVC49	10mm	Caps



HSA264

HANDY PACK MERCHANDISER

This merchandiser includes a selection of popular products:

- Rubber Grommets
- Blanking & Wiring Grommets
- Manifold Nuts
- Grease Nipples
- Nickel Plated Screws & Nuts
- Extension Springs
- Metal Machine Screws & Nuts
- Washers: Copper, Fibre, Flat, Steel, Star
- Body, Spring & Drain (Sump) Plugs
- Trim Clips, Xmas Tree & Canoe Clips
- Roofing Screws & Nuts
- Self-Tapping Screws
- Speed Nuts
- Split Pins
- Fuses: Glass & Blade
- Rivets

Champion
FASTENERS

HANDY PACKS

Part No. **HSA264**

Includes:

- 5 x 196 types of Handy Packs
- 3 x 56 types of 316 Stainless Steel Packs
- 3 x 10 types of Blister Assortments
- Total of 1178 Packs
- Merchandiser Dimensions: 600mm x 1610mm (incl. header board)

Merchandiser contents listing on pages 171-173

MERCHANDISER CONTENTS (262 TYPES)

WIRING GROMMETS - RUBBER

BH001	1/8 x 9/32"
BH002	3/16 x 5/16"
BH003	1/4 x 1/2"
BH004	5/16 x 17/32"
BH006	3/8 x 5/8"
BH007	3/8 x 3/4"
BH008	7/16 x 3/4"
BH009	1/2 x 21/32"
BH010	5/8 x 1"
BH011	3/4 x 15/16"



BLANKING GROMMETS - RUBBER

BH017	5/16" Panel Hole
BH018	3/8" Panel Hole
BH019	1/2" Panel Hole
BH020	5/8" Panel Hole
BH021	3/4" Panel Hole
BH022	7/8" Panel Hole
BH023	1" Panel Hole
BH024	1-1/8" Panel Hole



EXTENSION SPRINGS

BH036	3 x 7/16" x 18G
BH037	2-1/2 x 11/32" x 20G
BH038	3-1/8 x 11/32" x 20G
BH039	2-7/8 x 9/32" x 21G
BH040	2 x 9/32" x 21G



GREASE NIPPLES

BH053	1/4 UNF Straight
BH054	1/4 UNF 45°
BH057	1/8 BSP Straight
BH061	1/4 UNF x 1-1/4 Long
BH062	1/4 UNF 90°
BH063	6mm Straight
BH064	6mm 45°



COPPER WASHERS 20G

BH067	1/4 x 9/6"
BH068	5/16 x 5/8"
BH069	3/8 x 3/4"
BH070	7/16 x 13/16"
BH071	1/2 x 7/8"
BH072	5/8 x 1"
BH073	3/4 x 1-1/8"



Listing continued...

FINE THREAD SCREWS & NUTS	
BH077	6/40 x 3/4"
BH078	6/40 x 1"
BH079	8/36 x 1/2"
BH080	8/36 x 3/4"
BH081	8/36 x 1"
BH082	8/36 x 1-1/4"
BH083	10/32 x 1/2"
BH084	10/32 x 1"
BH086	10/32 x 1-1/2"



ROOFING BOLTS & NUTS	
BH090	3/16 x 1/2"
BH091	3/16 x 3/4"
BH092	3/16 x 1"
BH093	3/16 x 1-1/2"
BH094	1/4 x 3/4"
BH095	1/4 x 1"
BH096	1/4 x 1-1/2"



SPEED NUTS	
BH097	8G x 31/32 x 7/16"
BH098	10G x 13/16 x 1/2"
BH099	6G x 21/32 x 7/16"
BH101	1/8 x 1/2 x 5/16"
BH103	3/16 x 5/8 x 3/8"
BH106	8G x 21/32 x 7/16"
BH107	8G x 13/32 x 11/32"



FIBRE WASHERS (1/32" THICK)	
BH109	3/16 x 1/2"
BH110	1/4 x 9/16"
BH111	5/16 x 5/8"
BH112	3/8 x 3/4"
BH113	1/2 x 7/8"
BH114	5/8 x 1"
BH115	3/4 x 1-1/8"



SELF-TAPPING SCREWS – PAN HEAD	
BH121	8G x 1"
BH123	14G x 1/2"
BH125	14G x 3/4"
BH151	6G x 3/8"
BH152	8G x 1/2"
BH153	10G x 1/2"
BH158	10G x 1"
BH160	6G x 1/2"
BH165	10G x 3/4"
BH166	12G x 1"
BH498	6G x 1"
BH502	6G x 3/4"
BH503	8G x 3/4"
BH504	8G x 1-1/2"



EXTERNAL STAR WASHERS	
BH127	3/16"
BH128	1/4"
BH129	5/16"

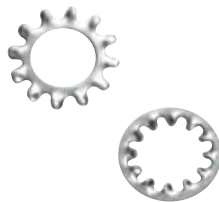

INTERNAL STAR WASHERS	
BH134	3/16"
BH135	1/4"
BH136	5/16"



SELF-TAPPING SCREWS – RAISED HEAD	
BH147	8G x 1"
BH149	8G x 1-1/2"
BH150	10G x 3/4"
BH156	8G x 3/4"
BH505	10G x 1"



FLAT STEEL WASHERS	
BH170	3/16"
BH171	1/4"
BH172	5/16"
BH173	3/8"
BH174	7/16"
BH175	1/2"
BH176	5/8"
BH177	3/4"
BH702	6mm
BH703	10mm
BH704	12mm



SPLIT PINS	
BH178	1.6 x 22mm
BH179	2.0 x 22mm
BH180	2.0 x 36mm
BH181	2.5 x 25mm
BH182	2.5 x 32mm
BH183	7/64 x 2"
BH184	7/64 x 1-1/4"
BH185	3.2 x 32mm
BH186	3.2 x 50mm
BH187	9/64 x 2"
BH188	4.0 x 50mm
BH193	2.5 x 50mm
BH194	5.0 x 50mm



PANEL (BODY) WASHERS	
BH226	1/4 x 1-1/4"
BH227	5/16 x 1-1/4"
BH228	3/8 x 1-1/4"



EXTERNAL SHAFT LOCKING RINGS	
BH260	4mm
BH261	5mm
BH262	6mm
BH263	8mm
BH264	10mm



'R' CLIPS	
BH270	Suits 3/16 to 1/4" Shaft
BH271	Suits 1/4 to 3/8" Shaft
BH272	Suits 5/16 to 1/2" Shaft
BH273	Suits 3/8 to 1/2" Shaft
BH274	Suits 7/16 to 3/4" Shaft
BH275	Suits 5/8 to 7/8" Shaft



SELF-DRILLING SCREWS	
BH280	10G x 16 x 16mm
BH281	10G x 16 x 22mm
BH282	10G x 16 x 30mm
BH283	8G x 18 x 22mm
BH284	8G x 18 x 16mm
BH285	8G x 18 x 20mm
BH286	8G x 18 x 25mm



MANIFOLD STUDS & NUTS	
BH290	3/8 x 2" UNC
BH291	8 x 38mm
BH292	7/16 x 2-1/4" UNC
BH293	10 x 43 x 1.25mm
BH294	10 x 40 x 1.5mm
BH295	3/8 x 3" UNC
BH296	3/8 x 1" UNC (Extractor Bolt)



SPRING WASHERS

BH328	1/4"
BH329	5/16"
BH330	3/8"
BH332	1/2"
BH336	6mm
BH338	10mm
BH713	7/16"
BH714	12mm



TRIM FASTENERS – PLASTIC

BH425	Canoe, Black
BH437	Xmas Tree Clip, Black



TRIM FASTENERS

BH438	Universal Door Trim
BH439	6mm Scrivet
BH440	6G Screw Grommet
BH441	8G Screw Grommet
BH442	10G Screw Grommet

MACHINE SCREWS – METRIC

BH620	4 x 10mm
BH621	5 x 16mm
BH622	5 x 20mm
BH623	6 x 16mm
BH624	6 x 20mm



DRAIN (SUMP) PLUG WASHERS

BH631	1/2" Suit No.1 Plug
BH632	1/2" O/S Suit No.1 O/S
BH633	5/8" Suit No.3 Plug
BH634	14mm Suit M14 Plug
BH635	18mm Suit M18 Plug



ALUMINIUM RIVETS

BH721	1/8" Medium
BH724	5/32" Medium
BH727	3/16" Medium



SELF-TAPPING SCREWS – BLACK ZINC

BH731	6G x 1/2"
BH732	6G 3/4"
BH733	6G x 1"
BH734	8G x 3/8"
BH735	8G x 5/8"
BH736	8G x 3/4"
BH737	8G x 1"
BH738	8G x 1-1/2"
BH739	10G x 1/2"
BH740	10G x 3/4"
BH741	10G x 1"
BH742	12G x 1"



SELF-TAPPING SCREWS WASHER FACE – BLACK ZINC

BH750	6G x 1/2"
BH751	6G x 3/4"
BH752	8G x 1/2"
BH753	8G x 3/4"
BH754	8G x 1"
BH755	10G x 1/2"
BH756	10G x 3/4"
BH757	12G x 1"



STAINLESS STEEL 316/A4

CSP02	6G x 1/2"	Self-Tapping Screws Countersunk
CSP03	6G x 3/4"	Self-Tapping Screws Countersunk
CSP04	6G x 1"	Self-Tapping Screws Countersunk
CSP05	8G x 3/4"	Self-Tapping Screws Countersunk
CSP06	8G x 1"	Self-Tapping Screws Countersunk
CSP07	10G x 3/4"	Self-Tapping Screws Countersunk
CSP08	10G x 1"	Self-Tapping Screws Countersunk
CSP09	4G x 5/8"	Self-Tapping Screws Pan Head
CSP10	6G x 1/2"	Self-Tapping Screws Pan Head
CSP11	6G x 3/4"	Self-Tapping Screws Pan Head
CSP12	6G x 1"	Self-Tapping Screws Pan Head
CSP13	8G x 3/8"	Self-Tapping Screws Pan Head
CSP14	8G x 1/2"	Self-Tapping Screws Pan Head
CSP15	8G x 3/4"	Self-Tapping Screws Pan Head
CSP16	8G x 1"	Self-Tapping Screws Pan Head
CSP17	10G x 1/2"	Self-Tapping Screws Pan Head
CSP18	10G x 1"	Self-Tapping Screws Pan Head
CSP19	6 x 25mm	Machine Screws & Nuts Pan Head
CSP20	6 x 50mm	Machine Screws & Nuts Pan Head
CSP21	6 x 25mm	Machine Screws & Nuts Pan Head
CSP22	6 x 50mm	Machine Screws & Nuts Pan Head
CSP23	6 x 32mm	Split Pins
CSP24	2 x 40mm	Split Pins
CSP25	2.5 x 40mm	Split Pins
CSP26	3.2 x 50mm	Split Pins
CSP27	4mm	Spring Washers
CSP28	5mm	Spring Washers
CSP29	6mm	Spring Washers
CSP30	8mm	Spring Washers
CSP31	10mm	Spring Washers
CSP32	4mm	Flat Washers
CSP33	5mm	Flat Washers
CSP34	6mm	Flat Washers
CSP35	8mm	Flat Washers
CSP36	10mm	Flat Washers
CSP37	4 x 20mm	Set Screws & Nuts
CSP38	4 x 35mm	Set Screws & Nuts
CSP39	5 x 25mm	Set Screws & Nuts
CSP40	5 x 35mm	Set Screws & Nuts
CSP41	6 x 16mm	Set Screws & Nuts
CSP42	6 x 25mm	Set Screws & Nuts
CSP43	6 x 40mm	Set Screws & Nuts
CSP44	8 x 25mm	Set Screws & Nuts
CSP45	8 x 35mm	Set Screws & Nuts
CSP46	8 x 40mm	Set Screws & Nuts
CSP47	8 x 50mm	Set Screws & Nuts
CSP48	10 x 25mm	Set Screws & Nuts
CSP49	10 x 35mm	Set Screws & Nuts
CSP50	10 x 50mm	Set Screws & Nuts
CSP51	5 x 10mm	Socket Head Screws
CSP52	5 x 25mm	Socket Head Screws
CSP53	6 x 16mm	Socket Head Screws
CSP54	6 x 25mm	Socket Head Screws
CSP55	8 x 16mm	Socket Head Screws
CSP56	8 x 25mm	Socket Head Screws
CSP57	10 x 25mm	Socket Head Screws

BLISTER ASSORTMENTS

CBB1	Blister Clevis Pin Assortment
CBB2	Blister 'R' Clip Assortment
CBB3	Blister Roll Pin Assortment
CBB4	Blister Imperial 'O' Ring Assortment
CBB5	Blister Metric 'O' Ring Assortment
CBB7	Blister Metric Grub Screw Assortment
CBB8	Blister Fibre Washer Assortment
CBB9	Blister Circlip Assortment
CBB10	Blister 'E' Clip Assortment
CBB11	Blister Sump Plug Assortment



COMBO STAND MERCHANDISER Part No. HSAB264



FRONT PROFILE

REAR PROFILE

HSAB264 COMBO STAND MERCHANDISER

This free-standing merchandiser contains a carefully selected range of the most popular products. A combination of products from BN254 and HSA264 are merged in this one merchandiser, and is suitable for smaller stores that require a smaller product range on one stand. Suitable for many industries, including automotive, hardware and industrial.

- Handy Packs
- High Tensile Bolts & Nuts
- 316 Stainless Steel
- Blister Assortments

Includes:

- 5 x 98 types of Handy Packs
- 3 x 98 types of High Tensile Bolt & Nut Packs
- 3 x 56 types of 316 Stainless Steel Packs
- 3 x 10 types of Blister Assortments
- Total of 982 Packs

Time saving thread tester is incorporated into stand



Merchandiser contents listing on pages 175-177

MERCHANDISER CONTENTS (262 TYPES)

WIRING GROMMETS – RUBBER

BH001	1/8 x 9/32"
BH002	3/16 x 5/16"
BH003	1/4 x 1/2"
BH004	5/16 x 17/32"
BH006	3/8 x 5/8"
BH007	3/8 x 3/4"
BH008	7/16 x 3/4"
BH009	1/2 x 21/32"
BH010	5/8 x 1"
BH011	3/4 x 15/16"



BLANKING GROMMETS – RUBBER

BH017	5/16" Panel Hole
BH018	3/8" Panel Hole
BH019	1/2" Panel Hole
BH020	5/8" Panel Hole
BH021	3/4" Panel Hole
BH022	7/8" Panel Hole
BH023	1" Panel Hole
BH024	1-1/8" Panel Hole



EXTENSION SPRINGS

BH036	3 x 7/16" x 18G
BH037	2-1/2 x 11/32" x 20G
BH038	3-1/8 x 11/32" x 20G
BH040	2 x 9/32" x 21G



GREASE NIPPLES

BH053	1/4" UNF Straight
BH054	1/4" UNF 45°
BH057	1/8" BSP Straight
BH061	1/4" UNF x 1-1/4 Long
BH062	1/4" UNF 90°
BH063	6mm Straight
BH064	6mm 45°



COPPER WASHERS 20G

BH068	5/16 x 5/8"
BH069	3/8 x 3/4"
BH070	7/16 x 13/16"
BH071	1/2 x 7/8"



FINE THREAD SCREWS & NUTS

BH079	8/36 x 1/2"
BH082	8/36 x 1-1/4"
BH083	10/32 x 1/2"
BH084	10/32 x 1"
BH086	10/32 x 1-1/2"



ROOFING BOLTS & NUTS

BH090	3/16 x 1/2"
BH091	3/16 x 3/4"
BH092	3/16 x 1"
BH093	3/16 x 1-1/2"



SPEED NUTS (CLIPS)

BH097	8G x 31/32 x 7/16"
BH098	10G x 13/16 x 1/2"
BH099	6G x 21/32 x 7/16"
BH106	8G x 21/32 x 7/16"



FIBRE WASHERS (1/32" THICK)

BH109	3/16 x 1/2"
BH110	1/4 x 9/16"



SELF-TAPPING SCREWS – PAN HEAD

BH125	14G x 3/4"
BH151	6G x 3/8"
BH152	8G x 1/2"
BH153	10G x 1/2"
BH156	8G x 3/4"
BH158	10G x 1"
BH160	6G x 1/2"
BH165	10G x 3/4"
BH166	12G x 1"
BH503	8G x 3/4"



FLAT STEEL WASHERS

BH170	3/16"
BH171	1/4"
BH172	5/16"
BH173	3/8"
BH174	7/16"
BH175	1/2"
BH702	6mm



SPLIT PINS

BH178	1.6 x 22mm
BH180	2.0 x 36mm
BH181	2.5 x 25mm
BH183	7/64 x 2"
BH184	7/64 x 1-1/4"
BH185	3.2 x 32mm
BH186	3.2 x 50mm
BH187	9/64 x 2"
BH188	4.0 x 50mm
BH193	2.5 x 50mm
BH194	5.0 x 50mm



Listing continued...

PANEL (BODY) WASHERS		
BH226	1/4 x 1-1/4"	
BH227	5/16 x 1-1/4"	
BH228	3/8 x 1-1/4"	
		
SPRING WASHERS		
BH328	1/4"	
BH329	5/16"	
BH330	3/8"	
BH332	1/2"	
BH336	6mm	
BH338	10mm	
BH713	7/16"	
		
TRIM FASTENERS – PLASTIC		
BH425	Canoe, Black	
BH437	Xmas Tree Clip, Black	
		
TRIM FASTENERS		
BH438	Universal Door Trim	
		
MACHINE SCREWS – METRIC		
BH620	4 x 10mm	
BH621	5 x 16mm	
BH623	6 x 16mm	
BH624	6 x 20mm	
		
DRAIN (SUMP) PLUG WASHERS		
BH632	1/2" O/S Suit No.1 O/S	
BH633	5/8" Suit No.3 Plug	
BH634	14mm Suit M14 Plug	
BH635	18mm Suit M18 Plug	
		
UNC THREAD		
BC1	1/4 x 1/2"	Set Screws & Nuts
BC3	1/4 x 3/4"	Set Screws & Nuts
BC4	1/4 x 1"	Set Screws & Nuts
BC6	1/4 x 1-1/4"	Set Screws & Nuts
BC8	1/4 x 1-1/2"	Set Screws & Nuts
BC11	1/4 x 2"	Set Screws & Nuts
BC13	1/4 x 2-1/2"	Bolts & Nuts
BC15	5/16 x 3/4"	Set Screws & Nuts
BC17	5/16 x 1"	Set Screws & Nuts
BC19	5/16 x 1-1/4"	Set Screws & Nuts
BC20	5/16 x 1-1/2"	Bolts & Nuts
BC21	5/16 x 1-1/2"	Set Screws & Nuts
BC23	5/16 x 2"	Bolts & Nuts
BC26	5/16 x 2-1/2"	Bolts & Nuts
BC28	5/16 x 3"	Bolts & Nuts
BC31	3/8 x 3/4"	Set Screws & Nuts
BC33	3/8 x 1"	Set Screws & Nuts

UNC THREAD <i>Continued</i>			
BC34	B	3/8 x 1-1/4"	Set Screws & Nuts
BC36	B	3/8 x 1-1/2"	Set Screws & Nuts
BC37	B	3/8 x 1-1/2"	Bolts & Nuts
BC40	B	3/8 x 2"	Set Screws & Nuts
BC42	B	3/8 x 2-1/2"	Bolts & Nuts
BC43	B	3/8 x 3"	Bolts & Nuts
BC50	B	7/16 x 1"	FSet Screws & Nuts
BC78	A	5/16" UNC	Hex Nuts
BC79	A	3/8" UNC	Hex Nuts

UNF THREAD			
BF1	A	1/4 x 1/2"	Set Screws & Nuts
BF3	A	1/4 x 3/4"	Set Screws & Nuts
BF4	A	1/4 x 1"	Set Screws & Nuts
BF8	A	1/4 x 1-1/2"	Set Screws & Nuts
BF15	A	5/16 x 3/4"	Set Screws & Nuts
BF17	A	5/16 x 1"	Set Screws & Nuts
BF19	A	5/16 x 1-1/4"	Set Screws & Nuts
BF21	A	5/16 x 1-1/2"	Set Screws & Nuts
BF23	B	5/16 x 2"	Bolts & Nuts
BF26	A	5/16 x 2-1/2"	Bolts & Nuts
BF31	A	3/8 x 3/4"	Set Screws & Nuts
BF33	B	3/8 x 1"	Set Screws & Nuts
BF34	B	3/8 x 1-1/4"	Set Screws & Nuts
BF36	B	3/8 x 1-1/2"	Set Screws & Nuts
BF78	A	5/16" UNF	Hex Nuts
BF79	A	3/8" UNF	Hex Nuts

METRIC THREAD			
BM12	A	5 x 16mm	Set Screws & Nuts
BM13	A	5 x 20mm	Set Screws & Nuts
BM14	A	5 x 25mm	Set Screws & Nuts
BM15	A	5 x 30mm	Set Screws & Nuts
BM18	A	5 x 50mm	Set Screws & Nuts
BM21	A	6 x 16mm	Set Screws & Nuts
BM22	A	6 x 20mm	Set Screws & Nuts
BM23	A	6 x 25mm	Set Screws & Nuts
BM25	A	6 x 30mm	Set Screws & Nuts
BM26	A	6 x 35mm	Set Screws & Nuts
BM27	A	6 x 40mm	Set Screws & Nuts
BM29	A	6 x 50mm	Bolts & Nuts
BM30	A	6 x 50mm	Set Screws & Nuts
BM32	A	6 x 60mm	Bolts & Nuts
BM34	A	6 x 70mm	Bolts & Nuts
BM35	A	6 x 80mm	Bolts & Nuts
BM37	A	6 x 100mm	Bolts & Nuts
BM40	A	7 x 35mm	Set Screws & Nuts
BM45	A	8 x 16mm	Set Screws & Nuts
BM47	A	8 x 20mm	Set Screws & Nuts
BM48	A	8 x 25mm	Set Screws & Nuts
BM51	A	8 x 30mm	Set Screws & Nuts
BM52	A	8 x 35mm	Set Screws & Nuts
BM55	A	8 x 40mm	Set Screws & Nuts
BM57	A	8 x 50mm	Bolts & Nuts

METRIC THREAD *Continued*

BM58	A	8 x 50mm	Fully Threaded Set Screws & Nuts
BM60	B	8 x 60mm	Bolts & Nuts
BM63	A	8 x 65mm	Bolts & Nuts
BM65	B	8 x 75mm	Bolts & Nuts
BM67	A	8 x 80mm	Bolts & Nuts
BM69	B	8 x 100mm	Bolts & Nuts
BM70	C	8 x 100mm	Set Screws & Nuts
BM79	B	10 x 25mm	Set Screws & Nuts
BM83	B	10 x 35mm	Set Screws & Nuts
BM84	B	10 x 40mm	Set Screws & Nuts
BM88	C	10 x 50mm	Set Screws & Nuts
BM98	B	10 x 100mm	Bolts & Nuts
BM99	C	10 x 100mm	Set Screws & Nuts
BM102	B	10 x 35 x 1.0	Set Screws & Nuts
BM104	A	10 x 25 x 1.25	Set Screws & Nuts
BM106	B	10 x 35 x 1.25	Set Screws & Nuts
BM109	B	10 x 45 x 1.25	Set Screws & Nuts
BM110	B	10 x 50 x 1.25	Set Screws & Nuts
BM112	C	10 x 70 x 1.25	Bolts & Nuts
BM116	C	12 x 30mm	Set Screws & Nuts
BM120	B	12 x 40mm	Set Screws & Nuts
BM135	C	12 x 100mm	Bolts & Nuts
BM136	C	12 x 100mm	Set Screws & Nuts
BM152	B	12 x 50 x 1.25	Set Screws & Nuts
BM157	A	5 x 0.8mm	Metric Hex Nuts
BM159	A	6 x 1.0mm	Metric Hex Nuts
BM161	A	8 x 1.25mm	Metric Hex Nuts
BM163	A	10 x 1.5mm	Metric Hex Nuts
BM164	A	10 x 1.25mm	Metric Hex Nuts
BM166	A	12 x 1.75mm	Metric Hex Nuts
BM168	A	12 x 1.25mm	Metric Hex Nuts

STAINLESS STEEL 316/A4

CSP02	A	6G x 1/2"	Self-Tapping Screws Countersunk
CSP03	B	6G x 3/4"	Self-Tapping Screws Countersunk
CSP04	B	6G x 1"	Self-Tapping Screws Countersunk
CSP05	B	8G x 3/4"	Self-Tapping Screws Countersunk
CSP06	B	8G x 1"	Self-Tapping Screws Countersunk
CSP07	B	10G x 3/4"	Self-Tapping Screws Countersunk
CSP08	B	10G x 1"	Self-Tapping Screws Countersunk
CSP09	B	4G x 5/8"	Self-Tapping Screws Pan Head
CSP10	B	6G x 1/2"	Self-Tapping Screws Pan Head
CSP11	B	6G x 3/4"	Self-Tapping Screws Pan Head
CSP12	B	6G x 1"	Self-Tapping Screws Pan Head
CSP13	B	8G x 3/8"	Self-Tapping Screws Pan Head
CSP14	B	8G x 1/2"	Self-Tapping Screws Pan Head
CSP15	B	8G x 3/4"	Self-Tapping Screws Pan Head
CSP16	B	8G x 1"	Self-Tapping Screws Pan Head
CSP17	B	10G x 1/2"	Self-Tapping Screws Pan Head
CSP18	B	10G x 1"	Self-Tapping Screws Pan Head
CSP19	A	6 x 25mm	Machine Screw & Nuts Pan Head

STAINLESS STEEL 316/A4 *Continued*

CSP20	A	6 x 50mm	Machine Screw & Nuts Pan Head
CSP21	A	6 x 25mm	Machine Screw & Nuts Countersunk
CSP22	A	6 x 50mm	Machine Screw & Nuts Countersunk
CSP23	A	6 x 32mm	Split Pins
CSP24	B	2 x 40mm	Split Pins
CSP25	B	2.5 x 40mm	Split Pins
CSP26	B	3.2 x 50mm	Split Pins
CSP27	A	4mm	Spring Washers
CSP28	A	5mm	Spring Washers
CSP29	A	6mm	Spring Washers
CSP30	A	8mm	Spring Washers
CSP31	A	10mm	Spring Washers
CSP32	A	4mm	Flat Washers
CSP33	A	5mm	Flat Washers
CSP34	A	6mm	Flat Washers
CSP35	A	8mm	Flat Washers
CSP36	A	10mm	Flat Washers
CSP37	B	4 x 20mm	Set Screws & Nuts
CSP38	B	4 x 35mm	Set Screws & Nuts
CSP39	B	5 x 25mm	Set Screws & Nuts
CSP40	B	5 x 35mm	Set Screws & Nuts
CSP41	B	6 x 16mm	Set Screws & Nuts
CSP42	B	6 x 25mm	Set Screws & Nuts
CSP43	B	6 x 40mm	Set Screws & Nuts
CSP44	B	8 x 25mm	Set Screws & Nuts
CSP45	B	8 x 35mm	Set Screws & Nuts
CSP46	B	8 x 40mm	Set Screws & Nuts
CSP47	B	8 x 50mm	Set Screws & Nuts
CSP48	B	10 x 25mm	Set Screws & Nuts
CSP49	B	10 x 35mm	Set Screws & Nuts
CSP50	B	10 x 50mm	Set Screws & Nuts
CSP51	A	5 x 10mm	Socket Head Screws
CSP52	A	5 x 25mm	Socket Head Screws
CSP53	A	6 x 16mm	Socket Head Screws
CSP54	A	6 x 25mm	Socket Head Screws
CSP55	B	8 x 16mm	Socket Head Screws
CSP56	B	8 x 25mm	Socket Head Screws
CSP57	B	10 x 25mm	Socket Head Screws

BLISTER ASSORTMENTS

CBB1	Blister Clevis Pin Assortment
CBB2	Blister 'R' Clip Assortment
CBB3	Blister Roll Pin Assortment
CBB4	Blister Imperial 'O' Ring Assortment
CBB5	Blister Metric 'O' Ring Assortment
CBB7	Metric Grub Screw Assortment
CBB8	Fibre Washer Assortment
CBB9	Circlip Assortment
CBB10	'E' Clip Assortment
CBB11	Sump Plug Assortment



AUTOMOTIVE MERCHANDISER 1 Part No. MERCHAUTO1



FRONT PROFILE



REAR PROFILE

MERCHAUTO1 AUTOMOTIVE MERCHANDISER 1

This stand has a popular range of brass fittings for automotive and is designed to sit beside the Automotive Merchandiser Two (Part No. MerchAuto2). It is aimed at providing a diverse range of fasteners for automotive outlets that would cover just about all automotive needs. The stand includes a thread tester for customer self service.

- Vacuum Connectors
- Brass Packs
- Bolt & Nut Packs (UNC & UNF GR5, METRIC GR8.8)

Includes:

- 3 x 20 Vacuum Connectors
- 3 x 63 Brass Packs
- 3 x 169 Bolt & Nut Packs
- Total of 756 Packs



Merchandiser contents listing on pages 179-181

MERCHANDISER CONTENTS (252 TYPES)

UNC THREAD, GR5

BC1	1/4 x 1/2"	Set Screws & Nuts
BC3	1/4 x 3/4"	Set Screws & Nuts
BC4	1/4 x 1"	Set Screws & Nuts
BC6	1/4 x 1-1/4"	Set Screws & Nuts
BC8	1/4 x 1-1/2"	Set Screws & Nuts
BC11	1/4 x 2"	Set Screws & Nuts
BC15	5/16 x 3/4"	Set Screws & Nuts
BC17	5/16 x 1"	Set Screws & Nuts
BC19	5/16 x 1-1/4"	Set Screws & Nuts
BC20	5/16 x 1-1/2"	Bolts & Nuts
BC21	5/16 x 1-1/2"	Set Screws & Nuts
BC23	5/16 x 2"	Bolts & Nuts
BC26	5/16 x 2-1/2"	Bolts & Nuts
BC28	5/16 x 3"	Bolts & Nuts
BC31	3/8 x 3/4"	Set Screws & Nuts
BC33	3/8 x 1"	Set Screws & Nuts
BC34	3/8 x 1-1/4"	Set Screws & Nuts
BC36	3/8 x 1-1/2"	Set Screws & Nuts
BC37	3/8 x 1-1/2"	Bolts & Nuts
BC40	3/8 x 2"	Set Screws & Nuts
BC42	3/8 x 2-1/2"	Bolts & Nuts
BC43	3/8 x 3"	Bolts & Nuts
BC45	3/8 x 3-1/2"	Bolts & Nuts
BC47	3/8 x 4"	Bolts & Nuts
BC50	7/16 x 1"	Set Screws & Nuts
BC60	7/16 x 3-1/2"	Bolts & Nuts
BC61	7/16 x 4"	Bolts & Nuts
BC75	1/2 x 3-1/2"	Bolts & Nuts
BC78	5/16"	Hexagon Nuts
BC79	3/8"	Hexagon Nuts
SHC3	1/4 x 3/4"	Socket Head Screw
SHC15	5/16 x 3/4"	Socket Head Screw
SHC17	5/16 x 1"	Socket Head Screw
SHC19	5/16 x 1-1/4"	Socket Head Screw
SLC77	1/4"	Nylon Insert Locking Nuts
SLC78	5/16"	Nylon Insert Locking Nuts
SLC79	3/8"	Nylon Insert Locking Nuts
SLC81	1/2"	Nylon Insert Locking Nuts

UNF THREAD, GR5

BF1	1/4 x 1/2"	Set Screws & Nuts
BF3	1/4 x 3/4"	Set Screws & Nuts
BF4	1/4 x 1"	Set Screws & Nuts
BF15	5/16 x 3/4"	Set Screws & Nuts

UNF THREAD, GR5 *Continued*

BF17	5/16 x 1"	Set Screws & Nuts
BF19	5/16 x 1-1/4"	Set Screws & Nuts
BF21	5/16 x 1-1/2"	Set Screws & Nuts
BF23	5/16 x 2"	Bolts & Nuts
BF26	5/16 x 2-1/2"	Bolts & Nuts
BF31	3/8 x 3/4"	Set Screws & Nuts
BF33	3/8 x 1"	Set Screws & Nuts
BF34	3/8 x 1-1/4"	Set Screws & Nuts
BF36	3/8 x 1-1/2"	Set Screws & Nuts
BF50	7/16 x 1"	Set Screws & Nuts
BF52	7/16 x 1-1/4"	Set Screws & Nuts
BF57	7/16 x 2"	Bolts & Nuts
BF58	7/16 x 2-1/2"	Bolts & Nuts
BF77	1/4"	Hexagon Nuts
BF78	5/16"	Hexagon Nuts
BF79	3/8"	Hexagon Nuts
BF80	7/16"	Hexagon Nuts
SLF77	1/4"	Nylon Insert Locking Nuts
SLF78	5/16"	Nylon Insert Locking Nuts
SLF79	3/8"	Nylon Insert Locking Nuts
SLF81	1/2"	Nylon Insert Locking Nuts

METRIC THREAD, GR8.8

BM12	5 x 16mm	Set Screws & Nuts
BM13	5 x 20mm	Set Screws & Nuts
BM14	5 x 25mm	Set Screws & Nuts
BM15	5 x 30mm	Set Screws & Nuts
BM18	5 x 50mm	Set Screws & Nuts
BM21	6 x 16mm	Set Screws & Nuts
BM22	6 x 20mm	Set Screws & Nuts
BM23	6 x 25mm	Set Screws & Nuts
BM25	6 x 30mm	Set Screws & Nuts
BM26	6 x 35mm	Set Screws & Nuts
BM27	6 x 40mm	Set Screws & Nuts
BM29	6 x 50mm	Bolts & Nuts
BM30	6 x 50mm	Set Screws & Nuts
BM32	6 x 60mm	Bolts & Nuts
BM34	6 x 70mm	Bolts & Nuts
BM35	6 x 80mm	Bolts & Nuts
BM37	6 x 100mm	Bolts & Nuts
BM40	7 x 35mm	Set Screws & Nuts
BM45	8 x 16mm	Set Screws & Nuts
BM47	8 x 20mm	Set Screws & Nuts
BM48	8 x 25mm	Set Screws & Nuts
BM51	8 x 30mm	Set Screws & Nuts
BM52	8 x 35mm	Set Screws & Nuts

Listing continued...

METRIC THREAD, GR8.8 <i>Continued</i>		
BM55	8 x 40mm	Set Screws & Nuts
BM57	8 x 50mm	Bolts & Nuts
BM58	8 x 50mm	Set Screws & Nuts
BM60	8 x 60mm	Bolts & Nuts
BM63	8 x 65mm	Bolts & Nuts
BM65	8 x 75mm	Bolts & Nuts
BM67	8 x 80mm	Bolts & Nuts
BM69	8 x 100mm	Bolts & Nuts
BM70	8 x 100mm	Set Screws & Nuts
BM74	8 x 35 x 1.00mm	Set Screws & Nuts
BM79	10 x 25mm	Set Screws & Nuts
BM83	10 x 35mm	Set Screws & Nuts
BM84	10 x 40mm	Set Screws & Nuts
BM86	10 x 45mm	Bolts & Nuts
BM88	10 x 50mm	Set Screws & Nuts
BM89	10 x 60mm	Bolts & Nuts
BM95	10 x 75mm	Bolts & Nuts
BM96	10 x 80mm	Bolts & Nuts
BM98	10 x 100mm	Bolts & Nuts
BM99	10 x 100mm	Set Screws & Nuts
BM102	10 x 1.0 x 35mm	Set Screws & Nuts
BM104	10 x 1.25 x 25mm	Set Screws & Nuts
BM106	10 x 1.25 x 35mm	Set Screws & Nuts
BM109	10 x 1.25 x 45mm	Set Screws & Nuts
BM110	10 x 1.25 x 50mm	Set Screws & Nuts
BM112	10 x 1.25 x 70mm	Bolts & Nuts
BM116	12 x 30mm	Set Screws & Nuts
BM120	12 x 40mm	Set Screws & Nuts
BM123	12 x 45mm	Set Screws & Nuts
BM134	12 x 90mm	Bolts & Nuts
BM135	12 x 100mm	Bolts & Nuts
BM136	12 x 100mm	Set Screws & Nuts
BM140	12 x 1.5 x 35mm	Set Screws & Nuts
BM142	12 x 1.5 x 40mm	Bolts & Nuts
BM148	12 x 1.5 x 75mm	Bolts & Nuts
BM150	12 x 1.25 x 35mm	Set Screws & Nuts
BM152	12 x 1.25 x 50	Set Screws & Nuts
BM154	12 x 1.25 x 75mm	Bolts & Nuts
BM157	5 x 0.8mm Nuts	Hexagon Nuts
BM159	6 x 1.0mm Nuts	Hexagon Nuts
BM161	8 x 1.25mm Nuts	Hexagon Nuts
BM163	10 x 1.5mm Nuts	Hexagon Nuts
BM164	10 x 1.25mm Nuts	Hexagon Nuts
BM168	12 x 1.25mm Nuts	Hexagon Nuts
SHM21	6 x 16mm	Socket Head Screws
SHM22	6 x 20mm	Socket Head Screws

METRIC THREAD, GR8.8 <i>Continued</i>		
SHM23	6 x 25mm	Socket Head Screws
SHM25	6 x 30mm	Socket Head Screws
SHM27	6 x 40mm	Socket Head Screws
SHM30	6 x 50mm	Socket Head Screws
SHM45	8 x 16mm	Socket Head Screws
SHM48	8 x 25mm	Socket Head Screws
SLM157	5 x 0.8mm	Nylon Insert Locking Nuts
SLM158	6 x 1.00mm	Nylon Insert Locking Nuts
SLM161	8 x 1.25mm	Nylon Insert Locking Nuts
SLM162	8 x 1mm	Nylon Insert Locking Nuts
SLM163	10 x 1.5mm	Nylon Insert Locking Nuts
SLM164	10 x 1.25mm	Nylon Insert Locking Nuts
SLM165	10 x 1mm	Nylon Insert Locking Nuts
SLM166	12 x 1.75mm	Nylon Insert Locking Nuts
SLM167	12 x 1.5mm	Nylon Insert Locking Nuts
SLM168	12 x 1.25mm	Nylon Insert Locking Nuts
FLANGE HEAD SET SCREWS & NUTS, GR8.8		
FBM12	5 x 16mm	Set Screws & Nuts
FBM14	5 x 25mm	Set Screws & Nuts
FBM21	6 x 16mm	Set Screws & Nuts
FBM22	6 x 20mm	Set Screws & Nuts
FBM23	6 x 25mm	Set Screws & Nuts
FBM25	6 x 30mm	Set Screws & Nuts
FBM27	6 x 40mm	Set Screws & Nuts
FBM45	8 x 16mm	Set Screws & Nuts
FBM47	8 x 20mm	Set Screws & Nuts
FBM48	8 x 25mm	Set Screws & Nuts
FBM51	8 x 30mm	Set Screws & Nuts
FBM55	8 x 40mm	Set Screws & Nuts
FBM57	8 x 50mm	Set Screws & Nuts
FBM104	10 x 1.25 x 25mm	Set Screws & Nuts
FBM106	10 x 1.25 x 35mm	Set Screws & Nuts
FBM107	10 x 1.25 x 40mm	Set Screws & Nuts
FBM110	10 x 1.25 x 50mm	Set Screws & Nuts
HEX FLANGE NUTS, GR8.8		
FBM157	5 x 0.8mm	Nuts
FBM159	6 x 1.0mm	Nuts
FBM161	8 x 1.25mm	Nuts
FBM164	10 x 1.25mm	Nuts
VACUUM CONNECTORS		
CVC1	3mm	'T' Piece
CVC2	5mm	'T' Piece
CVC3	6mm	'T' Piece
CVC4	8mm	'T' Piece
CVC5	10mm	'T' Piece

VACUUM CONNECTORS <i>Continued</i>		
CVC7	5mm	90° Elbows
CVC8	6mm	90° Elbows
CVC9	8mm	90° Elbows
CVC17	3mm	Straight Connectors
CVC18	5mm	Straight Connectors
CVC19	6mm	Straight Connectors
CVC20	8mm	Straight Connectors
CVC21	10mm	Straight Connectors
CVC30	5mm	3 Way 'Y' Piece
CVC44	3mm	Caps
CVC45	4mm	Caps
CVC46	5mm	Caps
CVC47	6mm	Caps
CVC48	8mm	Caps
CVC49	10mm	Caps

BRASS FITTINGS

HC1	3/16"	Brass Hose Joiners
HC2	1/4"	Brass Hose Joiners
HC3	5/16"	Brass Hose Joiners
HC4	3/8"	Brass Hose Joiners
HC5	1/2"	Brass Hose Joiners
HC6	5/8"	Brass Hose Joiners
HC7	3/4"	Brass Hose Joiners
HC8	3/16"	Brass 'T' Joiners
HC9	1/4"	Brass 'T' Joiners
HC10	5/16"	Brass 'T' Joiners
HC11	3/8"	Brass 'T' Fittings
HC12	1/2"	Brass 'T' Fittings
HC13	5/8"	Brass 'T' Fittings
HC14	3/16 x 1/8"	Male Hose Barbs
HC15	1/4 x 1/8"	Male Hose Barbs
HC16	5/16 x 1/8"	Male Hose Barbs
HC17	3/8 x 1/8"	Male Hose Barbs
HC18	3/16 x 1/4"	Male Hose Barbs
HC19	1/4 x 1/4"	Male Hose Barbs
HC20	5/16 x 1/4"	Male Hose Barbs
HC21	3/8 x 1/4"	Male Hose Barbs
HC22	1/2 x 1/4"	Male Hose Barbs
HC23	5/8 x 1/4"	Male Hose Barbs
HC24	5/16 x 3/8"	Male Hose Barbs

BRASS FITTINGS <i>Continued</i>		
HC25	3/8 x 3/8"	Male Hose Barbs
HC26	1/2 x 3/8"	Male Hose Barbs
HC27	5/8 x 3/8"	Male Hose Barbs
HC28	3/8 x 1/2"	Male Hose Barbs
HC29	1/2 x 1/2"	Male Hose Barbs
HC30	5/8 x 1/2"	Male Hose Barbs
HC31	3/4 x 1/2"	Male Hose Barbs
HC33	1/4 x 1/8"	90° Male Elbows
HC34	5/16 x 1/8"	90° Male Elbows
HC36	5/16 x 1/4"	90° Male Elbows
HC37	3/8 x 1/4"	90° Male Elbows
HC38	1/2 x 1/4"	90° Male Elbows
HC40	5/8 x 3/8"	90° Male Elbows
HC42	5/8 x 1/2"	90° Male Elbows
HC43	1/4 - 1/8"	Hex Reducing Bush
HC44	3/8 - 1/4"	Hex Reducing Bush
HC45	1/2 - 1/4"	Hex Reducing Bush
HC46	1/8"	Hex Sockets
HC47	1/4"	Hex Sockets
HC48	1/8"	Female Brass 'T' Joiners
HC49	1/4"	Brass Female 'T' Joiners
HC50	1/8" BSP	Hex Taper Plugs
HC51	1/4" BSP	Hex Taper Plugs
HC52	3/8" BSP	Hex Taper Plugs
HC53	1/2" BSP	Hex Taper Plugs
HC54	1/8" BSP	Hex Nipple Blister
HC55	1/4" BSP	Hex Nipple Blister
HC56	3/8" BSP	Hex Nipple Blister
HC58	1/8" BSP	M/F Elbow Blister
HC59	1/4" BSP	M/F Elbow Blister
HC60	3/8 x 1/8"	Reducing Bush
HC62	1/2 x 3/8"	Reducing Bush
HC63	3/8" BSP	Hex Socket Blister
HC72	1/8" BSP	Female Elbows
HC73	1/4" BSP	Female Elbows
HC74	3/8" BSP	Female Elbows
HC85	3/8 x 1/4" BSP	Reducing Nipples
HC86	1/2 x 1/4" BSP	Reducing Nipples
HC86	1/2 x 1/4" BSP	Reducing Nipples
HC87	1/2 x 3/8" BSP	Reducing Nipples



AUTOMOTIVE MERCHANDISER 2 Part No. MERCHAUTO2



FRONT PROFILE



REAR PROFILE

MERCHAUTO2 AUTOMOTIVE MERCHANDISER 2

This stand includes a range of the high-turnover panel clips and Handy Packs, a range of Assortments Packs and 316 Stainless Steel. Matched with the Automotive Merchandiser One (Part No. MerchAuto1), these stands provide a selection of popular blister packs for all the automotive and industrial outlets.

- Blister Assortments
- Panel Packs
- 316 Stainless Steel
- Handy Packs

Includes:

- 3 x 10 Assortment Packs
- 3 x 32 Panel Packs
- 3 x 69 316 Stainless Steel Packs
- 5 x 151 Handy Packs
- Total of 1088 Packs



Merchandiser contents listing on pages 183-185

MERCHANDISER CONTENTS (262 TYPES)

WIRING GROMMETS

BH001	1/8 x 9/32"
BH002	3/16 x 5/16"
BH003	1/4 x 1/2"
BH004	5/16 x 17/32"
BH005	3/8 x 1/2"
BH006	3/8 x 5/8"
BH007	3/8 x 3/4"
BH008	7/16 x 3/4"
BH009	1/2 x 21/32"
BH010	5/8 x 1"
BH011	3/4 x 15/16"
BH012	29/32 x 1-1/4"



BLANKING GROMMETS

BH017	5/16"
BH018	3/8"
BH019	1/2"
BH020	5/8"
BH021	3/4"
BH022	7/8"
BH023	1"
BH024	1-1/8"



EXTENSION SPRINGS

BH034	3-3/4 x 1/2" x 17G
BH035	2-1/2 x 1/2" x 17G
BH036	3 x 7/16" x 18G
BH037	2-1/2 x 11/32" x 20G
BH038	3-1/8 x 11/32" x 20G
BH039	2-7/8 x 9/32" x 21G
BH040	2 x 9/32" x 21G



GREASE NIPPLES

BH053	1/4" UNF Straight
BH054	1/4" UNF 45°
BH057	1/8" BSP Straight
BH061	1/4" UNF x 1-1/4" Long
BH062	1/4" UNF 90°
BH063	6mm Straight
BH064	6mm 45°



COPPER WASHERS

BH067	1/4 x 9/16"
BH068	5/16 x 5/8"
BH069	3/8 x 3/4"
BH070	7/16 x 13/16"
BH071	1/2 x 7/8"
BH072	5/8 x 1"
BH073	3/4 x 1-1/8"



FINE THREAD SCREWS & NUTS

BH079	8/36 x 1/2"
BH082	8/36 x 1-1/4"
BH083	10/32 x 1/2"
BH086	10/32 x 1-1/2"



ROOFING BOLTS & NUTS

BH090	3/16 x 1/2"
BH091	3/16 x 3/4"
BH092	3/16 x 1"
BH093	3/16 x 1-1/2"
BH094	1/4 x 3/4"



SPEED NUTS

BH097	8G x 31/32 x 7/16"
BH098	10G x 13/16 x 1/2"
BH099	6G x 21/32 x 7/16"
BH101	1/8 x 1/2 x 5/16"
BH106	8G x 21/32 x 7/16"
BH107	8G x 13/32 x 11/32"



FIBRE WASHERS

BH109	3/16 x 1/2"
BH110	1/4 x 9/16"
BH111	5/16 x 5/8"
BH112	3/8 x 3/4"
BH113	1/2 x 7/8"
BH114	5/8 x 1"



SELF-TAPPING SCREWS

BH123	14G x 1/2"
BH125	14G x 3/4"
BH151	6G x 3/8"
BH152	8G x 1/2"
BH153	10G x 1/2"
BH156	8G x 3/4"
BH158	10G x 1"
BH165	10G x 3/4"
BH166	12G x 1"
BH503	8G x 3/4"



FLAT WASHERS

BH171	1/4"
BH172	5/16"
BH173	3/8"
BH174	7/16"
BH175	1/2"
BH176	5/8"
BH177	3/4"









SPLIT PINS

BH178	1.6 x 22mm
BH179	2 x 22mm
BH180	2 x 36mm
BH181	2.5 x 25mm
BH182	2.5 x 32mm
BH183	7/64 x 2"
BH184	7/64 x 1-1/4"
BH185	3.2 x 32mm
BH186	3.2 x 50mm
BH187	9/64 x 2"
BH188	4 x 50mm
BH193	2.5 x 50mm
BH194	5 x 50mm



Listing continued...

PANEL WASHERS	
BH226	1/4 x 1-1/4"
BH227	5/16 x 1-1/4"
BH228	3/8 x 1-1/4"
	
'R' CLIPS	
BH270	3/16 - 1/4" Shaft
BH271	1/4 - 3/8" Shaft
BH272	5/16 - 1/2" Shaft
BH274	7/16 - 3/4" Shaft
	
SELF-DRILLING SCREWS	
BH280	10G x 16 x 16mm
BH281	10G x 16 x 22mm
BH282	10G x 16 x 30mm
BH283	8G x 18 x 22mm
BH284	8G x 18 x 16mm
BH285	8G x 18 x 20mm
	
MANIFOLD STUDS	
BH290	3/8 x 2" UNC Stud
BH291	8 x 38mm Stud
BH293	10 x 1.25 x 43mm Stud
BH294	10 x 1.5 x 40mm Stud
BH295	3/8" UNC Stud
BH296	3/8 x 1" UNC Stud
	
SPRING WASHERS	
BH328	1/4"
BH329	5/16"
BH330	3/8"
BH332	1/2"
BH336	6mm
BH338	10mm
BH713	7/16"
BH714	12mm
	
TRIM CLIPS	
BH425	Canoe Black Trim Clips
BH437	Xmas Tree Clip Black Trim Clips
BH438	Universal Door Trim Clips
BH439	6mm Scrivet Trim Clips
BH440	6G Screw Grommet Trim Clips
BH441	8G Screw Grommet Trim Clips
BH442	10G Screw Grommet Trim Clips
	
MACHINE SCREWS – METRIC	
BH620	4 x 10mm
BH621	5 x 16mm
BH622	5 x 20mm
BH623	6 x 16mm
BH624	6 x 20mm
	

SUMP PLUG WASHERS	
BH631	Suits #1 Plug
BH634	Suits M14 Plug
BH635	Suits M18 Plug
	
FLAT WASHERS	
BH702	6mm
BH703	10mm
BH704	12mm
	
ALUMINIUM RIVET	
BH721	1/8" Medium
BH724	5/32" Medium
BH727	3/16" Medium
	
SELF-TAPPING SCREWS – BLACK ZINC	
BH735	8G x 5/8"
BH738	8G x 1-1/2"
BH739	10G x 1/2"
BH740	10G x 3/4"
BH742	12G x 1"
	
SELF-TAPPING WASHER FACE SCREWS – BLACK ZINC	
BH752	8G x 1/2"
BH753	8G x 3/4"
BH755	10G x 1/2"
BH756	10G x 3/4"
BH757	12G x 1"
	
BLISTER ASSORTMENTS	
CBB1	Clevis Pins
CBB2	'R' Clips
CBB3	Roll Pins
CBB4	Imperial 'O' Rings
CBB5	Metric 'O' Rings
CBB7	Metric Grub Screws
CBB8	Fibre Washers
CBB9	Circlips
CBB10	'E' Clips
CBB11	Sump Plugs
	
STAINLESS STEEL SELF-TAPPING SCREWS	
CSP02	6G x 1/2" Countersunk
CSP03	6G x 3/4" Countersunk
CSP05	8G x 3/4" Countersunk
CSP06	8G x 1" Countersunk
CSP07	10G x 3/4" Countersunk
CSP08	10G x 1" Countersunk
CSP96	8G x 1/2" Countersunk
CSP97	8G x 1-1/4" Countersunk
CSP09	4G x 5/8" Pan Head
CSP10	6G x 1/2" Pan Head
CSP11	6G x 3/4" Pan Head
CSP12	6G x 1" Pan Head
CSP13	8G x 3/8" Pan Head
	

STAINLESS STEEL SELF-TAPPING SCREWS *Continued*

CSP14	8G x 1/2" Pan Head	
CSP15	8G x 3/4" Pan Head	
CSP16	8G x 1" Pan Head	
CSP17	10G x 1/2" Pan Head	
CSP18	10G x 1" Pan Head	
CSP93	8G x 1-1/4" Pan Head	
CSP94	10G x 1-1/4" Pan Head	
CSP95	10G x 1-1/2" Pan Head	

STAINLESS STEEL MACHINE SCREWS & NUTS

CSP19	6 x 25mm Pan Head	
CSP20	6 x 50mm Pan Head	
CSP21	6 x 25mm Countersunk	
CSP22	6 x 50mm Countersunk	

STAINLESS STEEL SPLIT PINS

CSP23	1.6 x 32mm	
CSP24	2 x 40mm	
CSP25	2.5 x 40mm	
CSP26	3.2 x 50mm	

STAINLESS STEEL SPRING WASHERS

CSP27	4mm	
CSP28	5mm	
CSP29	6mm	
CSP30	8mm	
CSP31	10mm	

STAINLESS STEEL FLAT WASHERS

CSP32	4mm	
CSP33	5mm	
CSP34	6mm	
CSP35	8mm	
CSP36	10mm	

STAINLESS STEEL SET SCREWS & NUTS

CSP37	4 x 20mm	
CSP38	4 x 35mm	
CSP39	5 x 25mm	
CSP40	5 x 35mm	
CSP41	6 x 16mm	
CSP42	6 x 25mm	
CSP43	6 x 40mm	
CSP44	8 x 25mm	
CSP45	8 x 35mm	
CSP46	8 x 40mm	
CSP47	8 x 50mm	
CSP48	10 x 25mm	
CSP49	10 x 35mm	

STAINLESS STEEL SOCKET HEAD SCREWS

CSP51	5 x 10mm	
CSP52	5 x 25mm	
CSP53	6 x 16mm	
CSP54	6 x 25mm	
CSP55	8 x 16mm	
CSP56	8 x 25mm	
CSP57	10 x 25mm	

STAINLESS STEEL DOME NUTS

DN4	4mm	
DN5	5mm	
DN6	6mm	
DN8	8mm	
DN10	10mm	

STAINLESS STEEL SELF-LOCKING NUTS – 316/A4

SLN4	4mm	
SLN5	5mm	
SLN6	6mm	
SLN8	8mm	
SLN10	10mm	

TRIM CLIPS

TF1	Xmas Tree Clips	
TF3	Xmas Tree Clips	
TF4	Xmas Tree Clips	
TF5	Xmas Tree Clips	
TF6	Xmas Tree Clips	
TF8	Xmas Tree Clips	
TF10	Xmas Tree Clips	
TF11	Xmas Tree Clips	
TF12	Xmas Tree Clips, Grey	
TF13	Xmas Tree Clips	
TF18	Moulding Clips	
TF20	Canoe Clips	
TF23	Bonnet Insulation Clips	
TF24	Anchor Trim Clips	
TF25	Retainer Clips	
TF27	6mm Scrivet Clips	
TF28	Plastic Push Rivets	
TF29	6mm Hole Scrivet Clips	
TF30	8mm Hole Scrivet Clips	
TF31	Screw Rivets	
TF32	Splash Guard Clips	
TF33	6G Screw Grommets	
TF34	8G Screw Grommets	
TF36	10G Screw Grommets	
TF37	Door Trim Clips	
TF38	Door Trim Clips	
TF39	10mm Universal Door Trim Bush	
TF40	13mm Universal Door Trim Bush	
TF46	Door Trim Bush	
TF49	Window Winder Clips	
TF50	M5 Headlamp Captive Nuts	
TF51	M6 Short Captive Nuts	



AUTOMOTIVE MERCHANDISER 3

Part No. **MERCHAUTO3**



FRONT PROFILE



REAR PROFILE

MERCHAUTO3 AUTOMOTIVE MERCHANDISER 3

This stand is suitable for any automotive, hardware and industrial industry. The stand is designed as a stand alone merchandiser that offers a bit of everything. Offers a great return of investment if space is very limited and range has to be condensed.

- Bolts & Nuts
- Blister Assortments
- 316 Stainless Steel
- Trade Packs
- Brass Packs
- Handy Packs
- Panel Packs









Includes (time saving thread tester is incorporated into the stand):

- 3 x 87 Bolt & Nut Packs
- 3 x 15 Assortments
- 3 x 28 316 Stainless Steel Packs
- 3 x 20 Trade Packs
- 3 x 14 Brass Packs
- 3 x 71 Handy Packs
- 3 x 32 Panel Packs
- Total of 943 Packs



Merchandiser contents listing on pages 187-189

MERCHANDISER CONTENTS (267 TYPES)		
UNC THREAD, GR5		
BC1	1/4 x 1/2"	Set Screws & Nuts
BC3	1/4 x 3/4"	Set Screws & Nuts
BC15	5/16 x 3/4"	Set Screws & Nuts
BC17	5/16 x 1"	Set Screws & Nuts
BC19	5/16 x 1-1/4"	Set Screws & Nuts
BC33	3/8 x 1"	Set Screws & Nuts
BC34	3/8 x 1-1/4"	Set Screws & Nuts
SHC3	1/4 x 3/4"	UNC Socket Head Screws
SLC77	1/4" UNC	Nylon Insert Lock Nuts
SLC78	5/16" UNC	Nylon Insert Lock Nuts
SLC79	3/8" UNC	Nylon Insert Lock Nuts
SLC80	7/16" UNC	Nylon Insert Lock Nuts
SLC81	1/2" UNC	Nylon Insert Lock Nuts
UNF THREAD, GR5		
BF15	5/16 x 3/4"	Set Screws & Nuts
BF17	5/16 x 1"	Set Screws & Nuts
SLF77	1/4" UNF	Nylon Insert Lock Nuts
SLF78	5/16" UNF	Nylon Insert Lock Nuts
SLF79	3/8" UNF	Nylon Insert Lock Nuts
WIRING GROMMETS		
BH001	1/8 x 9/32"	
BH002	3/16 x 5/16"	
BH003	1/4 x 1/2"	
BH004	5/16 x 17/32"	
BH006	3/8 x 5/8"	
BH007	3/8 x 3/4"	
BH008	7/16 x 3/4"	
BH009	1/2 x 21/32"	
BH010	5/8 x 1"	
BH011	3/4 x 15/16"	
BLANKING GROMMETS		
BH017	5/16"	
BH018	3/8"	
BH019	1/2"	
BH020	5/8"	
BH021	3/4"	
BH022	7/8"	
BH023	1"	
BH024	1-1/8"	
EXTENSION SPRINGS		
BH036	3 x 7/16" x 18G	
BH037	2-1/2 x 11/32"	
BH038	3-1/8 x 11/32"	
BH040	2 x 9/32" x 21G	
GREASE NIPPLES		
BH053	1/4" UNF Straight	
BH057	1/8" BSP Straight	
BH062	1/4" UNF 90°	
BH063	6mm Straight	
BH064	6mm 45°	

COPPER WASHERS		
BH068	5/16 x 5/8"	
BH069	3/8 x 3/4"	
BH070	7/16 x 13/16"	
BH071	1/2 x 7/8"	
SPEED NUTS		
BH097	8G x 31/32 x 7/16"	
BH098	10G x 13/16 x 1/2"	
BH099	6G x 21/32 x 7/16"	
BH106	8G x 21/32 x 7/16"	
FIBRE WASHERS		
BH109	3/16 x 1/2"	
BH110	1/4 x 9/16"	
SELF-TAPPING SCREWS – PAN HEAD		
BH125	14G x 3/4"	
BH153	10G x 1/2"	
FLAT WASHERS		
BH170	3/16"	
BH171	1/4"	
BH172	5/16"	
BH173	3/8"	
BH174	7/16"	
BH175	1/2"	
BH703	10mm	
SPLIT PINS		
BH180	2 x 36mm	
BH181	2.5 x 25mm	
BH183	7/64 x 2"	
BH184	7/64 x 1-1/4"	
BH185	3.2 x 32mm	
BH186	3.2 x 50mm	
BH187	9/64 x 2"	
BH188	4 x 50mm	
BH193	2.5 x 50mm	
BH194	5 x 50mm	
PANEL WASHERS		
BH226	1/4 x 1-1/4"	
BH227	5/16 x 1-1/4"	
BH228	3/8 x 1-1/4"	
SPRING WASHERS		
BH328	1/4"	
BH329	5/16"	
BH330	3/8"	
BH713	7/16"	
BH332	1/2"	
BH336	6mm	
BH338	10mm	
TRIM CLIPS		
BH425	Canoe Black Trim Clip	
BH437	Xmas Tree Clip, Black	

Listing continued...

MACHINE SCREWS – METRIC		
BH620	4 x 10mm	
BH621	5 x 16mm	
BH623	6 x 16mm	
METRIC THREAD, GR8.8		
BM12	5 x 16mm	Set Screws & Nuts
BM13	5 x 20mm	Set Screws & Nuts
BM18	5 x 50mm	Set Screws & Nuts
BM21	6 x 16mm	Set Screws & Nuts
BM22	6 x 20mm	Set Screws & Nuts
BM23	6 x 25mm	Set Screws & Nuts
BM25	6 x 30mm	Set Screws & Nuts
BM27	6 x 40mm	Set Screws & Nuts
BM30	6 x 50mm	Set Screws & Nuts
BM40	7 x 35mm	Set Screws & Nuts
BM45	8 x 16mm	Set Screws & Nuts
BM47	8 x 20mm	Set Screws & Nuts
BM48	8 x 25mm	Set Screws & Nuts
BM51	8 x 30mm	Set Screws & Nuts
BM52	8 x 35mm	Set Screws & Nuts
BM55	8 x 40mm	Set Screws & Nuts
BM58	8 x 50mm	Set Screws & Nuts
BM70	8 x 100mm	Set Screws & Nuts
BM79	10 x 25mm	Set Screws & Nuts
BM83	10 x 35mm	Set Screws & Nuts
BM84	10 x 40mm	Set Screws & Nuts
BM88	10 x 50mm	Set Screws & Nuts
BM104	10 x 1.25 x 25mm	Set Screws & Nuts
BM106	10 x 1.25 x 35mm	Set Screws & Nuts
BM109	10 x 1.25 x 45mm	Set Screws & Nuts
BM152	12 x 1.25 x 50	Set Screws & Nuts
BM159	6 x 1.00mm	Hex Nuts
BM161	8 x 1.25mm	Hex Nuts
BM164	10 x 1.25mm	Hex Nuts
SHM21	6 x 16mm	Metric Socket Head Screws
SHM22	6 x 20mm	Metric Socket Head Screws
SHM23	6 x 25mm	Metric Socket Head Screws
SHM25	6 x 30mm	Metric Socket Head Screws
SHM27	6 x 40mm	Metric Socket Head Screws
SHM30	6 x 50mm	Metric Socket Head Screws
SHM34	6 x 70mm	Metric Socket Head Screws
SHM45	8 x 16mm	Metric Socket Head Screws
SHM48	8 x 25mm	Metric Socket Head Screws
SLM157	5 x 0.8mm	Nylon Insert Lock Nuts
SLM158	6 x 1mm	Nylon Insert Lock Nuts
SLM161	8 x 1.25mm	Nylon Insert Lock Nuts
SLM162	8 x 1mm	Nylon Insert Lock Nuts
SLM163	10 x 1.5mm	Nylon Insert Lock Nuts
SLM164	10 x 1.25mm	Nylon Insert Lock Nuts
SLM165	10 x 1mm	Nylon Insert Lock Nuts
SLM166	12 x 1.75mm	Nylon Insert Lock Nuts
SLM167	12 x 1.5mm	Nylon Insert Lock Nuts
SLM168	12 x 1.25mm	Nylon Insert Lock Nuts

FLANGE HEAD SET SCREWS & NUTS, GR8.8		
FBM21	6 x 16mm	Set Screws & Nuts
FBM22	6 x 20mm	Set Screws & Nuts
FBM23	6 x 25mm	Set Screws & Nuts
FBM25	6 x 30mm	Set Screws & Nuts
FBM27	6 x 40mm	Set Screws & Nuts
FBM45	8 x 16mm	Set Screws & Nuts
FBM47	8 x 20mm	Set Screws & Nuts
FBM48	8 x 25mm	Set Screws & Nuts
FBM51	8 x 30mm	Set Screws & Nuts
FBM55	8 x 40mm	Set Screws & Nuts
FBM57	8 x 50mm	Set Screws & Nuts
FBM104	10 x 1.25 x 25mm	Set Screws & Nuts
FBM106	10 x 1.25 x 35mm	Set Screws & Nuts
FBM107	10 x 1.25 x 40mm	Set Screws & Nuts
FBM110	10 x 1.25 x 50mm	Set Screws & Nuts
FBM12	5 x 16mm	Set Screws & Nuts
FBM14	5 x 25mm	Set Screws & Nuts
FBM157	5 x 0.8mm	Hex Flange Nuts
FBM159	6 x 1.0mm	Hex Flange Nuts
FBM161	8 x 1.25mm	Hex Flange Nuts
FBM164	10 x 1.25mm	Hex Flange Nuts

BLISTER ASSORTMENTS

CBB2	'R' Clips
CBB3	Roll Pins
CBB4	Imperial 'O' Rings
CBB5	Metric 'O' Rings
CBB7	Metric Grub Screws
CBB8	Fibre Washers
CBB9	Circlips
CBB10	'E' Clips
CBB11	Sump Plugs
CBB16	Grease Nipples
CBB17	Grease Nipples
CBB20	Wiring Grommets
CBB21	Blanking Grommets
CBB23	Split Pins
CBB31	Anti-Theft Screws



STAINLESS STEEL SELF-TAPPING SCREWS – PAN HEAD

CSP14	8G x 1/2"
CSP15	8G x 3/4"
CSP17	10G x 1/2"
CSP18	10G x 1"

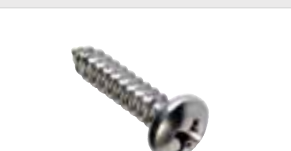

STAINLESS STEEL MACHINE SCREWS & NUTS

CSP19	6 x 25mm	Pan Head
CSP21	6 x 25mm	Countersunk

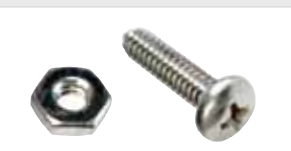

STAINLESS STEEL SPLIT PINS

CSP25	2.5 x 40mm	
CSP26	3.2 x 50mm	

STAINLESS STEEL SPRING WASHERS

CSP28	5mm	
CSP29	6mm	
CSP30	8mm	
CSP31	10mm	

STAINLESS STEEL FLAT WASHERS

CSP32	4mm	
CSP33	5mm	
CSP34	6mm	
CSP35	8mm	
CSP36	10mm	

STAINLESS STEEL SET SCREWS & NUTS

CSP37	4 x 20mm	
CSP38	4 x 35mm	
CSP39	5 x 25mm	
CSP41	6 x 16mm	
CSP42	6 x 25mm	
CSP44	8 x 25mm	

STAINLESS STEEL SOCKET HEAD SCREWS

CSP51	5 x 10mm	
CSP52	5 x 25mm	
CSP53	6 x 16mm	
CSP54	6 x 25mm	
CSP56	8 x 25mm	

VACUUM CONECTORS

CVC1	3mm	'T' Piece	
CVC2	5mm	'T' Piece	
CVC3	6mm	'T' Piece	
CVC4	8mm	'T' Piece	
CVC5	10mm	'T' Piece	
CVC7	5mm	90° Elbows	
CVC8	6mm	90° Elbows	
CVC9	8mm	90° Elbows	
CVC17	3mm	Straight Connect.	
CVC18	5mm	Straight Connect.	
CVC19	6mm	Straight Connect.	
CVC20	8mm	Straight Connect.	
CVC21	10mm	Straight Connect.	
CVC30	5mm	3 Way 'Y' Piece	
CVC44	3mm	Caps	
CVC45	4mm	Caps	
CVC46	5mm	Caps	
CVC47	6mm	Caps	
CVC48	8mm	Caps	
CVC49	10mm	Caps	

BRASS HOSE JOINERS

HC2	1/4"	Brass Hose Joiners	
HC3	5/16"	Brass Hose Joiners	
HC4	3/8"	Brass Hose	
HC5	1/2"	Brass Hose	
HC6	5/8"	Brass Hose	
HC10	5/16"	Brass 'T' Joiners	
HC11	3/8"	Brass 'T' Fittings	
HC14	3/16 x 1/8"	Male Hose Barbs	
HC15	1/4 x 1/8"	Male Hose Barbs	
HC16	5/16 x 1/8"	Male Hose Barbs	
HC17	3/8 x 1/8"	Male Hose Barbs	
HC20	5/16 x 1/4"	Male Hose Barbs	
HC21	3/8 x 1/4"	Male Hose Barbs	
HC40	5/8 x 3/8	90° Male Elbows	
HC45	1/2 - 1/4"	Hex Reducing Bush	

TRIM CLIPS

TF1	Xmas Tree Clips	
TF3	Xmas Tree Clips	
TF4	Xmas Tree Clips	
TF5	Xmas Tree Clips	
TF6	Xmas Tree Clips	
TF8	Xmas Tree Clips	
TF10	Xmas Tree Clips	
TF11	Xmas Tree Clips	
TF12	Xmas Tree Clips, Grey	
TF13	Xmas Tree Clips	
TF18	Moulding Clips	
TF20	Canoe Clips	
TF23	Bonnet Insulation Clip	
TF24	Anchor Trim Clips	
TF25	Retainer Clips	
TF27	6mm Scrivet Clips	
TF28	Plastic Push Rivets	
TF29	Scrivet Clips - 6mm Hole	
TF30	Scrivet Clips - 8mm Hole	
TF31	Screw Rivets	
TF32	Splash Guard Clips	
TF33	6G Screw Grommets	
TF34	8G Screw Grommets	
TF36	10G Screw Grommets	
TF37	Door Trim Clips	
TF38	Door Trim Clips	
TF39	Universal Door Trim Bush 10mm	
TF40	Universal Door Trim Bush 13mm	
TF46	Door Trim Bush	
TF49	Window Winder Clips	
TF50	M5 Headlamp Captive Nuts	
TF51	M6 Short Captive Nuts	



STAINLESS STEEL & HANDY PACK COMBO Part No. HP100

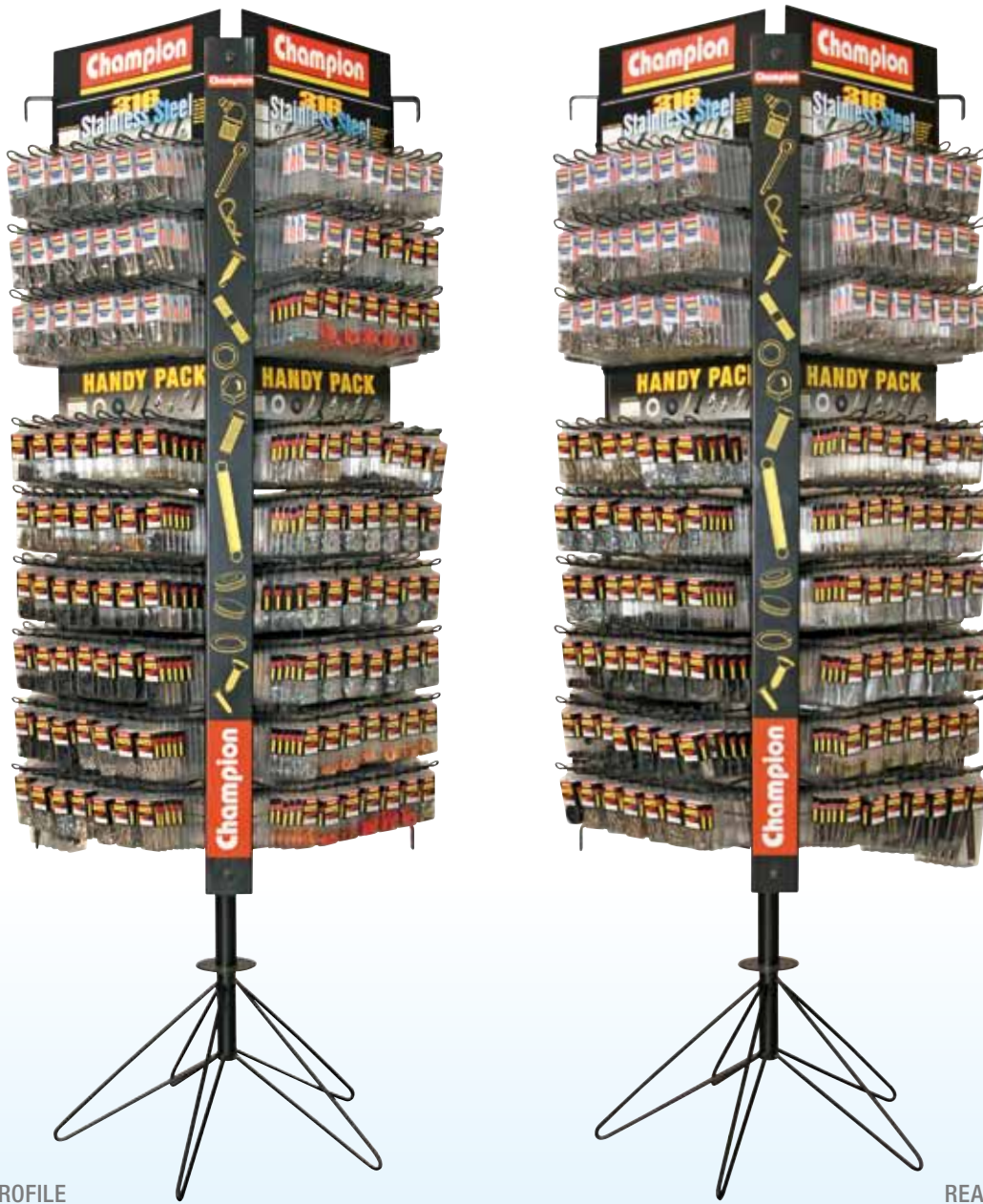

FRONT PROFILE

REAR PROFILE

HP100

STAINLESS STEEL & HANDY PACK COMBO

This stand is a combination of 316 Grade Stainless Steel blisters and a range of Handy Packs that will cover most automotive, marine and handy man requirements. This stand is suitable for automotive and hardware. This stand works in conjunction with the BN200 to give your store an extensive range to cover your customer's needs.

- 316 Stainless Steel
- Handy Packs







Includes:

- 3 x 73 316 Stainless Steel Packs
- 5 x 179 Handy Packs
- Total of 1114 Packs

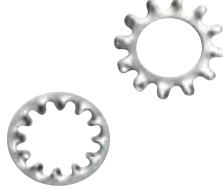

Merchandiser contents listing on pages 191-193

MERCHANDISER CONTENTS (252 TYPES)	
WIRING GROMMETS	
BH001	1/8 x 9/32"
BH002	3/16 x 5/16"
BH003	1/4 x 1/2"
BH004	5/16 x 17/32"
BH005	3/8 x 1/2"
BH006	3/8 x 5/8"
BH007	3/8 x 3/4"
BH008	7/16 x 3/4"
BH009	1/2 x 21/32"
BH010	5/8 x 1"
BH011	3/4 x 15/16"
BH012	29/32 x 1-1/4"
BLANKING GROMMETS	
BH017	5/16"
BH018	3/8"
BH019	1/2"
BH020	5/8"
BH021	3/4"
BH022	7/8"
BH023	1"
BH024	1-1/8"
EXTENSION SPRINGS	
BH034	3-3/4 x 1/2" x 17G
BH035	2-1/2 x 1/2" x 17G
BH036	3 x 7/16" x 18G
BH037	2-1/2 x 11/32" x 20G
BH038	3-1/8 x 11/32" x 20G
BH039	2-7/8 x 9/32" x 21G
BH040	2 x 9/32" x 21G
GREASE NIPPLES	
BH053	1/4" UNF Straight
BH054	1/4" UNF 45°
BH057	1/8" BSP Straight
BH061	1/4" UNF x 1-1/4" Long
BH062	1/4" UNF 90°
BH063	6mm Straight
BH064	6mm 45°
COPPER WASHERS	
BH067	1/4 x 9/16"
BH068	5/16 x 5/8"
BH069	3/8 x 3/4"
BH070	7/16 x 13/16"
BH071	1/2 x 7/8"
BH072	5/8 x 1"
BH073	3/4 x 1-1/8"

FINE THREAD SCREWS & NUTS		
BH077	6/40 x 3/4"	
BH079	8/36 x 1/2"	
BH080	8/36 x 3/4"	
BH081	8/36 x 1"	
BH082	8/36 x 1-1/4"	
BH083	10/32 x 1/2"	
BH086	10/32 x 1-1/2"	
ROOFING BOLTS & NUTS		
BH090	3/16 x 1/2"	
BH091	3/16 x 3/4"	
BH092	3/16 x 1"	
BH093	3/16 x 1-1/2"	
BH094	1/4 x 3/4"	
BH095	1/4 x 1"	
BH096	1/4 x 1-1/2"	
SPEED NUTS		
BH097	8G x 31/32 x 7/16"	
BH098	10G x 13/16 x 1/2"	
BH099	6G x 21/32 x 7/16"	
BH101	1/8 x 1/2 x 5/16"	
BH106	8G x 21/32 x 7/16"	
FIBRE WASHERS		
BH109	3/16 x 1/2"	
BH110	1/4 x 9/16"	
BH111	5/16 x 5/8"	
BH112	3/8 x 3/4"	
BH113	1/2 x 7/8"	
STAR WASHERS		
BH127	3/16" External	
BH128	1/4" External	
BH134	3/16" Internal	
BH135	1/4" Internal	
BH136	5/16" Internal	
SELF-TAPPING SCREWS – PAN HEAD		
BH121	8G x 1"	
BH123	14G x 1/2"	
BH125	14G x 3/4"	
BH151	6G x 3/8"	
BH152	8G x 1/2"	
BH153	10G x 1/2"	
BH158	10G x 1"	
BH165	10G x 3/4"	
BH166	12G x 1"	
BH503	8G x 3/4"	
BH504	8G x 1-1/2"	

Listing continued...

SELF-TAPPING SCREWS – RAISED HEAD	
BH147	8G x 1"
BH149	8G x 1-1/2"
BH150	10G x 3/4"
BH156	8G x 3/4"
BH505	10G x 1"



SELF-TAPPING SCREWS – BLACK ZINC	
BH731	6G x 1/2"
BH732	6G x 3/4"
BH734	8G x 3/8"
BH735	8G x 5/8"
BH736	8G x 3/4"
BH737	8G x 1"
BH738	8G x 1-1/2"
BH739	10G x 1/2"
BH740	10G x 3/4"
BH741	10G x 1"
BH742	12G x 1"



SELF-TAPPING WASHER FACE SCREWS – BLACK ZINC	
BH750	6G x 1/2"
BH751	6G x 3/4"
BH752	8G x 1/2"
BH753	8G x 3/4"
BH754	8G x 1"
BH755	10G x 1/2"
BH756	10G x 3/4"
BH757	12G x 1"



FLAT WASHERS	
BH170	3/16"
BH171	1/4"
BH172	5/16"
BH173	3/8"
BH174	7/16"
BH175	1/2"
BH176	5/8"
BH177	3/4"



SPLIT PINS	
BH178	1.6 x 22mm
BH179	2 x 22mm
BH180	2 x 36mm
BH181	2.5 x 25mm
BH182	2.5 x 32mm
BH183	7/64 x 2"
BH184	7/64 x 1-1/4"
BH185	3.2 x 32mm
BH186	3.2 x 50mm
BH187	9/64 x 2"
BH188	4 x 50mm
BH193	2.5 x 50mm
BH194	5 x 50mm



PANEL WASHERS	
BH226	1/4 x 1-1/4"
BH227	5/16 x 1-1/4"
BH228	3/8 x 1-1/4"



EXTERNAL SHAFT LOCKING RINGS	
BH260	4mm
BH261	5mm
BH262	6mm
BH263	8mm



'R' CLIPS	
BH270	3/16 - 1/4" Shaft
BH271	1/4 - 3/8" Shaft
BH272	5/16 - 1/2" Shaft
BH273	3/8 - 1/2" Shaft
BH274	7/16 - 3/4" Shaft
BH275	5/8 - 7/8" Shaft



SELF-DRILLING SCREWS	
BH280	10G x 16 x 16mm
BH281	10G x 16 x 22mm
BH282	10G x 16 x 30mm
BH283	8G x 18 x 22mm
BH284	8G x 18 x 16mm
BH285	8G x 18 x 20mm
BH286	8G x 18 x 25mm



MANIFOLD STUDS	
BH290	3/8 x 2" UNC Stud
BH291	8 x 38mm Stud
BH293	10 x 1.25 x 43mm Stud
BH294	10 x 1.5 x 40mm Stud
BH296	3/8 x 1" UNC Stud



SPRING WASHERS	
BH328	1/4"
BH329	5/16"
BH330	3/8"
BH713	7/16"
BH332	1/2"
BH336	6mm
BH338	10mm
BH714	12mm



TRIM CLIPS	
BH425	Canoe Clips, Black
BH437	Xmas Tree Clips, Black
BH438	Universal Door
BH439	6mm Scrivets
BH440	6G Screw Grommets
BH441	8G Screw Grommets
BH442	10G Screw Grommets



MACHINE SCREWS – METRIC

BH620	4 x 10mm
BH621	5 x 16mm
BH622	5 x 20mm
BH623	6 x 16mm
BH624	6 x 20mm



SUMP PLUG WASHERS

BH631	Suits #1 Plug
BH632	Suits #1 Oversize Plug
BH633	Suits #3 Plug
BH634	Suits M14 Plug
BH635	Suits M18 Plug



FLAT WASHERS

BH702	6mm
BH703	10mm
BH704	12mm



STAINLESS STEEL SELF-TAPPING SCREWS

CSP02	6G x 1/2" Countersunk
CSP03	6G x 3/4" Countersunk
CSP04	6G x 1" Countersunk
CSP05	8G x 3/4" Countersunk
CSP06	8G x 1" Countersunk
CSP07	10G x 3/4" Countersunk
CSP08	10G x 1" Countersunk
CSP09	4G x 5/8" Pan Head
CSP10	6G x 1/2" Pan Head
CSP11	6G x 3/4" Pan Head
CSP12	6G x 1" Pan Head
CSP13	8G x 3/8" Pan Head
CSP14	8G x 1/2" Pan Head
CSP15	8G x 3/4" Pan Head
CSP16	8G x 1" Pan Head
CSP17	10G x 1/2" Pan Head
CSP18	10G x 1" Pan Head



STAINLESS STEEL MACHINE SCREWS & NUTS

CSP19	6 x 25mm Pan Head
CSP20	6 x 50mm Pan Head
CSP21	6 x 25mm Countersunk
CSP22	6 x 50mm Countersunk



STAINLESS STEEL SPLIT PINS

CSP23	1.6 x 32mm
CSP24	2 x 40mm
CSP25	2.5 x 40mm
CSP26	3.2 x 50mm



STAINLESS STEEL SPRING WASHERS

CSP27	4mm
CSP28	5mm
CSP29	6mm
CSP30	8mm
CSP31	10mm



STAINLESS STEEL FLAT WASHERS

CSP32	4mm
CSP33	5mm
CSP34	6mm
CSP35	8mm
CSP36	10mm



STAINLESS STEEL SET SCREWS & NUTS

CSP37	4 x 20mm
CSP38	4 x 35mm
CSP39	5 x 25mm
CSP40	5 x 35mm
CSP41	6 x 16mm
CSP42	6 x 25mm
CSP43	6 x 40mm
CSP44	8 x 25mm
CSP45	8 x 35mm
CSP46	8 x 40mm
CSP47	8 x 50mm
CSP48	10 x 25mm
CSP49	10 x 35mm
CSP50	10 x 50mm



STAINLESS STEEL SOCKET HEAD SCREWS

CSP51	M5 x 10
CSP52	M5 x 25
CSP53	M6 x 16
CSP54	M6 x 25
CSP55	M8 x 16
CSP56	M8 x 25
CSP57	M10 x 25



STAINLESS STEEL SELF-TAPPING SCREWS – PAN HEAD

CSP93	8G x 1-1/4"
CSP94	10G x 1-1/4"
CSP95	10G x 1-1/2"
CSP96	8G x 1/2"
CSP97	8G x 1-1/4"
CSP98	8G x 1-1/4"
CSP99	8G x 1-1/2"



STAINLESS STEEL DOME NUTS

DN4	M4
DN5	M5
DN6	6mm
DN8	8mm
DN10	10mm



STAINLESS STEEL SELF-LOCKING NUTS – 316/A4

SLN4	M4
SLN5	M5
SLN6	6mm
SLN8	8mm
SLN10	10mm





HIGH TENSILE & PANEL PACK COMBO Part No. BN200



FRONT PROFILE

REAR PROFILE

BN200 HIGH TENSILE & PANEL PACK COMBO

This stand incorporates High Tensile Bolts & Nuts, Flange Head Bolts & Nuts, Socket Head Screws and more. Designed to stand alongside the HP100 to provide a full range suited for both the automotive and hardware industries. The BN200 stand incorporates a time saving thread tester and is suitable for full size or high turnover stores.

- Trade Packs
- Panel Packs
- Blister Assortments
- Bolts & Nuts
- Thread Lock

Includes:

- 3 x 18 Trade Packs
- 3 x 42 Panel Packs
- 3 x 23 Assortment Packs
- 3 x 199 of Bolt & Nut Packs
- 3 x 5 Thread Lock
- Total of 861 Packs



Merchandiser contents listing on pages 195-197

MERCHANDISER CONTENTS (287 TYPES)

UNC THREAD, GR5

BC1	1/4 x 1/2"	Set Screws & Nuts
BC3	1/4 x 3/4"	Set Screws & Nuts
BC4	1/4 x 1"	Set Screws & Nuts
BC6	1/4 x 1-1/4"	Set Screws & Nuts
BC8	1/4 x 1-1/2"	Set Screws & Nuts
BC9	1/4 x 1-1/2"	Bolts & Nuts
BC11	1/4 x 2"	Set Screws & Nuts
BC14	1/4 x 3"	Bolts & Nuts
BC15	5/16 x 3/4"	Set Screws & Nuts
BC17	5/16 x 1"	Set Screws & Nuts
BC19	5/16 x 1-1/4"	Set Screws & Nuts
BC20	5/16 x 1-1/2"	Bolts & Nuts
BC21	5/16 x 1-1/2"	Set Screws & Nuts
BC23	5/16 x 2"	Bolts & Nuts
BC26	5/16 x 2-1/2"	Bolts & Nuts
BC31	3/8 x 3/4"	Set Screws & Nuts
BC33	3/8 x 1"	Set Screws & Nuts
BC34	3/8 x 1-1/4"	Set Screws & Nuts
BC36	3/8 x 1-1/2"	Set Screws & Nuts
BC37	3/8 x 1-1/2"	Bolts & Nuts
BC38	3/8 x 1-3/4"	Bolts & Nuts
BC39	3/8 x 2"	Bolts & Nuts
BC40	3/8 x 2"	Set Screws & Nuts
BC42	3/8 x 2-1/2"	Bolts & Nuts
BC43	3/8 x 3"	Bolts & Nuts
BC44	3/8 x 3"	Set Screws & Nuts
BC45	3/8 x 3-1/2"	Bolts & Nuts
BC47	3/8 x 4"	Bolts & Nuts
BC50	7/16 x 1"	Set Screws & Nuts
BC54	7/16 x 1-1/2"	Set Screws & Nuts
BC60	7/16 x 3-1/2"	Bolts & Nuts
BC61	7/16 x 4"	Bolts & Nuts
BC63	1/2 x 1-1/4"	Set Screws & Nuts
BC65	1/2 x 1-1/2"	Bolts & Nuts
BC66	1/2 x 1-1/2"	Set Screws & Nuts
BC69	1/2 x 2"	Bolts & Nuts
BC70	1/2 x 2"	Set Screws & Nuts
BC75	1/2 x 3-1/2"	Bolts & Nuts
BC76	1/2 x 4"	Bolts & Nuts
BC78	5/16"	Hexagon Nuts
BC79	3/8"	Hexagon Nuts
SLC77	1/4"	Nylon Insert Locking Nuts
SLC78	5/16"	Nylon Insert Locking Nuts
SLC79	3/8"	Nylon Insert Locking Nuts
SLC80	7/16"	Nylon Insert Locking Nuts
SLC81	1/2"	Nylon Insert Locking Nuts

UNF THREAD, GR5

BF1	1/4 x 1/2"	Set Screws & Nuts
BF3	1/4 x 3/4"	Set Screws & Nuts
BF4	1/4 x 1"	Set Screws & Nuts
BF7	1/4 x 1-1/4"	Bolts & Nuts
BF8	1/4 x 1-1/2"	Set Screws & Nuts
BF11	1/4 x 2"	Set Screws & Nuts
BF14	1/4 x 3"	Bolts & Nuts
BF15	5/16 x 3/4"	Set Screws & Nuts
BF17	5/16 x 1"	Set Screws & Nuts
BF19	5/16 x 1-1/4"	Set Screws & Nuts
BF20	5/16 x 1-1/2"	Set Screws & Nuts
BF21	5/16 x 1-1/2"	Set Screws & Nuts
BF23	5/16 x 2"	Bolts & Nuts
BF31	3/8 x 3/4"	Set Screws & Nuts
BF33	3/8 x 1"	Set Screws & Nuts
BF34	3/8 x 1-1/4"	Set Screws & Nuts
BF36	3/8 x 1-1/2"	Set Screws & Nuts
BF37	3/8 x 1-1/2"	Bolts & Nuts
BF50	7/16 x 1"	Set Screws & Nuts
BF52	7/16 x 1-1/4"	Set Screws & Nuts
BF54	7/16 x 1-1/2"	Set Screws & Nuts
BF57	7/16 x 2"	Bolts & Nuts
BF62	1/2 x 1"	Set Screws & Nuts
BF63	1/2 x 1-1/4"	Set Screws & Nuts
BF65	1/2 x 1-1/2"	Bolts & Nuts
BF66	1/2 x 1-1/2"	Set Screws & Nuts
BF69	1/2 x 2"	Bolts & Nuts
BF75	1/2 x 3-1/2"	Bolts & Nuts
BF78	5/16"	Hexagon Nuts
BF79	3/8"	Hexagon Nuts
BF80	7/16"	Hexagon Nuts

METRIC THREAD, GR8.8

BM12	5 x 16mm	Set Screws & Nuts
BM13	5 x 20mm	Set Screws & Nuts
BM14	5 x 25mm	Set Screws & Nuts
BM15	5 x 30mm	Set Screws & Nuts
BM18	5 x 50mm	Set Screws & Nuts
BM21	6 x 16mm	Set Screws & Nuts
BM22	6 x 20mm	Set Screws & Nuts
BM23	6 x 25mm	Set Screws & Nuts
BM25	6 x 30mm	Set Screws & Nuts
BM26	6 x 35mm	Set Screws & Nuts
BM27	6 x 40mm	Set Screws & Nuts
BM29	6 x 50mm	Bolts & Nuts
BM30	6 x 50mm	Set Screws & Nuts
BM32	6 x 60mm	Bolts & Nuts
BM34	6 x 70mm	Bolts & Nuts
BM35	6 x 80mm	Bolts & Nuts

Listing continued...

METRIC THREAD, GR8.8 <i>Continued</i>		
BM37	6 x 100mm	Bolts & Nuts
BM40	7 x 35mm	Set Screws & Nuts
BM45	8 x 16mm	Set Screws & Nuts
BM47	8 x 20mm	Set Screws & Nuts
BM48	8 x 25mm	Set Screws & Nuts
BM51	8 x 30mm	Set Screws & Nuts
BM52	8 x 35mm	Set Screws & Nuts
BM55	8 x 40mm	Set Screws & Nuts
BM57	8 x 50mm	Bolts & Nuts
BM58	8 x 50mm	Set Screws & Nuts
BM60	8 x 60mm	Bolts & Nuts
BM63	8 x 65mm	Bolts & Nuts
BM65	8 x 75mm	Bolts & Nuts
BM67	8 x 80mm	Bolts & Nuts
BM69	8 x 100mm	Bolts & Nuts
BM70	8 x 100mm	Set Screws & Nuts
BM74	8 x 1.00 x 35mm	Set Screws & Nuts
BM77	8 x 1.00 x 50mm	Bolts & Nuts
BM79	10 x 25mm	Set Screws & Nuts
BM83	10 x 35mm	Set Screws & Nuts
BM84	10 x 40mm	Set Screws & Nuts
BM86	10 x 45mm	Bolts & Nuts
BM87	10 x 50mm	Bolts & Nuts
BM88	10 x 50mm	Set Screws & Nuts
BM89	10 x 60mm	Bolts & Nuts
BM91	10 x 65mm	Bolts & Nuts
BM93	10 x 70mm	Bolts & Nuts
BM95	10 x 75mm	Bolts & Nuts
BM96	10 x 80mm	Bolts & Nuts
BM98	10 x 100mm	Bolts & Nuts
BM99	10 x 100mm	Set Screws & Nuts
BM102	10 x 1.00 x 35mm	Set Screws & Nuts
BM104	10 x 1.25 x 25mm	Set Screws & Nuts
BM106	10 x 1.25 x 35mm	Set Screws & Nuts
BM109	10 x 1.25 x 45mm	Set Screws & Nuts
BM110	10 x 1.25 x 50mm	Set Screws & Nuts
BM112	10 x 1.25 x 70mm	Bolts & Nuts
BM116	12 x 30mm	Set Screws & Nuts
BM120	12 x 40mm	Set Screws & Nuts
BM123	12 x 45mm	Set Screws & Nuts
BM124	12 x 50mm	Set Screws & Nuts
BM125	12 x 50mm	Bolts & Nuts
BM126	12 x 60mm	Bolts & Nuts
BM128	12 x 65mm	Bolts & Nuts
BM131	12 x 70mm	Bolts & Nuts
BM133	12 x 80mm	Bolts & Nuts
BM134	12 x 90mm	Bolts & Nuts
BM135	12 x 100mm	Bolts & Nuts
BM136	12 x 100mm	Set Screws & Nuts

METRIC THREAD, GR8.8 <i>Continued</i>		
BM140	12 x 1.5 x 35mm	Set Screws & Nuts
BM142	12 x 1.5 x 40mm	Bolts & Nuts
BM144	12 x 1.5 x 50mm	Bolts & Nuts
BM145	12 x 1.5 x 50mm	Set Screws & Nuts
BM147	12 x 1.5 x 60mm	Bolts & Nuts
BM148	12 x 1.5 x 75mm	Bolts & Nuts
BM150	12 x 1.25 x 35mm	Set Screws & Nuts
BM152	12 x 1.25 x 50mm	Set Screws & Nuts
BM154	12 x 1.25 x 75mm	Bolts & Nuts
BM157	5 x 0.8mm	Hexagon Nuts
BM159	6 x 1.00mm	Hexagon Nuts
BM161	8 x 1.25mm	Hexagon Nuts
BM162	8 x 1.00mm	Hexagon Nuts
BM163	10 x 1.5mm	Hexagon Nuts
BM164	10 x 1.25mm	Hexagon Nuts
BM165	10 x 1.00mm	Hexagon Nuts
BM166	12 X 1.75mm	Hexagon Nuts
BM167	12 X 1.50mm	Hexagon Nuts
BM168	12 x 1.25mm	Hexagon Nuts
SHM21	6 x 16mm	Socket Head Screws
SHM22	6 x 20mm	Socket Head Screws
SHM23	6 x 25mm	Socket Head Screws
SHM25	6 x 30mm	Socket Head Screws
SHM27	6 x 40mm	Socket Head Screws
SHM48	8 x 25mm	Socket Head Screws
SLM157	5 x 0.8mm	Nylon Insert Locking Nuts
SLM158	6 x 1mm	Nylon Insert Locking Nuts
SLM160	7 x 1mm	Nylon Insert Locking Nuts
SLM161	8 x 1.25mm	Nylon Insert Locking Nuts
SLM162	8 x 1.00mm	Nylon Insert Locking Nuts
SLM163	10 x 1.5mm	Nylon Insert Locking Nuts
SLM164	10 x 1.25mm	Nylon Insert Locking Nuts
SLM165	10 x 1.00mm	Nylon Insert Locking Nuts
SLM166	12 x 1.75mm	Nylon Insert Locking Nuts
SLM167	12 x 1.5mm	Nylon Insert Locking Nuts
SLM168	12 x 1.25mm	Nylon Insert Locking Nuts
FLANGE HEAD SET SCREWS & NUTS, GR8.8		
FBM12	5 x 16mm	Set Screws & Nuts
FBM14	5 x 25mm	Set Screws & Nuts
FBM21	6 x 16mm	Set Screws & Nuts
FBM22	6 x 20mm	Set Screws & Nuts
FBM23	6 x 25mm	Set Screws & Nuts
FBM25	6 x 30mm	Set Screws & Nuts
FBM27	6 x 40mm	Set Screws & Nuts
FBM45	8 x 16mm	Set Screws & Nuts
FBM47	8 x 20mm	Set Screws & Nuts
FBM48	8 x 25mm	Set Screws & Nuts
FBM51	8 x 30mm	Set Screws & Nuts
FBM55	8 x 40mm	Set Screws & Nuts
FBM57	8 x 50mm	Set Screws & Nuts

FLANGE HEAD, GR8.8 *Continued*

FBM104	10 x 1.25 x 25mm	Set Screws & Nuts
FBM106	10 x 1.25 x 35mm	Set Screws & Nuts
FBM107	10 x 1.25 x 40mm	Set Screws & Nuts
FBM110	10 x 1.25 x 50mm	Set Screws & Nuts
FBM157	5 x 0.8mm	Hex Flange Nuts
FBM159	6 x 1.0mm	Hex Flange Nuts
FBM161	8 x 1.25mm	Hex Flange Nuts
FBM164	10 x 1.25mm	Hex Flange Nuts

BLISTER ASSORTMENTS

CBB2	'R' Clips	
CBB4	Imperial 'O' Rings	
CBB5	Metric 'O' Rings	
CBB7	Metric Grub Screws	
CBB8	Fibre Washers	
CBB9	Circlips	
CBB10	'E' Clips	
CBB11	Sump Plugs	
CBB13	Shaft Lock Rings	
CBB14	Speed Nuts	
CBB31	Anti-Theft Screws	

ALUMINIUM RIVETS

CBBR1	3/32 x 0.290"	
CBBR2	1/8 x 0.290"	
CBBR3	1/8 x 0.400"	
CBBR4	1/8 x 0.500"	
CBBR5	1/8 x 0.650"	
CBBR6	5/32 x 0.290"	
CBBR7	5/32 x 0.450"	
CBBR8	5/32 x 0.500"	
CBBR9	3/16 x 0.350"	
CBBR10	3/16 x 0.490"	
CBBR11	3/16 x 0.570"	
CBBR12	3/16 x 0.650"	

VACUUM CONECTORS

CVC1	3mm 'T' Piece	
CVC2	5mm 'T' Piece	
CVC3	6mm 'T' Piece	
CVC4	8mm 'T' Piece	
CVC5	10mm 'T' Piece	
CVC7	5mm 90° Elbows	
CVC8	6mm 90° Elbows	
CVC9	8mm 90° Elbows	
CVC18	5mm Str. Connectors	
CVC19	6mm Str. Connectors	
CVC20	8mm Str. Connectors	
CVC21	10mm Str. Connectors	

VACUUM CONECTORS *Continued*

CVC44	3mm Caps	
CVC45	4mm Caps	
CVC46	5mm Caps	
CVC47	6mm Caps	
CVC48	8mm Caps	
CVC49	10mm Caps	

TRIM CLIPS

PP02	Xmas Tree Clips, Beige	
PP03	Xmas Tree Clips, Grey	
PP04	Xmas Tree Clips, Black	
PP06	Canoe Clips, Black	
PP08	6mm Scrivet Clips	
PP12	6G Screw Grommets	
PP13	8G Screw Grommets	
PP14	6G Screw Grommets	
PP15	10G Screw Grommets	
PP16	Weather Seal Clips	
PP30	Xmas Tree Clips	
PP31	Xmas Tree Clips	
PP32	Xmas Tree Clips, Grey	
PP33	Xmas Tree Clips	
PP36	Screw Rivets	
PP38	Moulding Clips	
PP39	Door Trim Bush	
PP41	10mm Univ. Door Trim Bush	
PP42	13mm Univ. Door Trim Bush	
PP45	Hex Nuts 8mm	
PP47	Hex Flange Nuts 6mm	
PP48	12G x 3/4 Hex Hd Sem Assm	
PP49	14G x 5/8 Hex Hd Sem Assm	
PP50	M6 x 18 Hex Hd Sem Assm	
PP56	Xmas Tree Clips	
PP57	Xmas Tree Clips	
PP58	Xmas Tree Clips	
PP59	Xmas Tree Clips	
PP60	Xmas Tree Clips	
PP61	Xmas Tree Clips	
PP63	Xmas Tree Clips	
PP66	Plastic Push Rivets	
PP67	Scrivet Clips, 6mm Hole	
PP68	Scrivet Clips, 8mm Hole	
PP74	M6 Short Captive Nuts	
PP75	M6 Long Captive Nuts	
PP76	M8 Short Captive Nuts	
PP77	M8 Long Captive Nuts	
PP81	Window Winder Clips	
PP91	Door Trim Clips	
PP92	Door Trim Clips	
PP93	Retainer Clips	

THREAD LOCK

TL262	Thread Lock - 10ml
-------	--------------------



CSP056M-1 STAINLESS STEEL MERCHANDISER

A carefully selected range of Marine Grade 316/A4 Stainless Steel products, packaged in reusable clam shell with a two price structure. Barcoded for easy identification.

- Self-Tapping Screws
- Spring & Flat Washer
- Split Pins
- Machine Screws & Nuts
- Bolts & Nuts
- Socket Head Cap Screws

Includes:

- 3 x 56 types of Marine Grade 316/A4 Stainless Steel
- Total of 168 Packs
- Merchandiser Dimensions: 440mm x 900mm



STAINLESS STEEL

Part No. **CSP056M-1**

MERCHANDISER CONTENTS (56 TYPES)

MARINE GRADE 316/A4 STAINLESS STEEL

CSP02	6G x 1/2"	Self-Tapping Screws Countersunk
CSP03	6G x 3/4"	Self-Tapping Screws Countersunk
CSP04	6G x 1"	Self-Tapping Screws Countersunk
CSP05	8G x 3/4"	Self-Tapping Screws Countersunk
CSP06	8G x 1"	Self-Tapping Screws Countersunk
CSP07	10G x 3/4"	Self-Tapping Screws Countersunk
CSP08	10G x 1"	Self-Tapping Screws Countersunk
CSP09	4G x 5/8"	Self-Tapping Screws Pan x Rec
CSP10	6G x 1/2"	Self-Tapping Screws Pan x Rec
CSP11	6G x 3/4"	Self-Tapping Screws Pan x Rec
CSP12	6G x 1"	Self-Tapping Screws Pan x Rec
CSP13	8G x 3/8"	Self-Tapping Screws Pan x Rec
CSP14	8G x 1/2"	Self-Tapping Screws Pan x Rec
CSP15	8G x 3/4"	Self-Tapping Screws Pan x Rec
CSP16	8G x 1"	Self-Tapping Screws Pan x Rec
CSP17	10G x 1/2"	Self-Tapping Screws Pan x Rec
CSP18	10G x 1"	Self-Tapping Screws Pan x Rec
CSP19	6 x 25mm	Screws & Nuts Pan x Rec
CSP20	6 x 50mm	Screws & Nuts Pan x Rec
CSP21	6 x 25mm	Screws & Nuts Countersunk
CSP22	6 x 50mm	Screws & Nuts Countersunk
CSP23	1.6 x 32mm	Split Pins
CSP24	2.0 x 40mm	Split Pins
CSP25	2.5 x 40mm	Split Pins
CSP26	3.2 x 50mm	Split Pins
CSP27	4mm	Spring Washers
CSP28	5mm	Spring Washers
CSP29	6mm	Spring Washers
CSP30	8mm	Spring Washers
CSP31	10mm	Spring Washers
CSP32	4mm	Flat Washers
CSP33	5mm	Flat Washers
CSP34	6mm	Flat Washers
CSP35	8mm	Flat Washers
CSP36	10mm	Flat Washers
CSP37	4 x 20mm	Set Screws & Nuts
CSP38	4 x 35mm	Set Screws & Nuts
CSP39	5 x 25mm	Set Screws & Nuts
CSP40	5 x 35mm	Set Screws & Nuts
CSP41	6 x 16mm	Set Screws & Nuts
CSP42	6 x 25mm	Set Screws & Nuts
CSP43	6 x 40mm	Set Screws & Nuts
CSP44	8 x 25mm	Set Screws & Nuts
CSP45	8 x 35mm	Set Screws & Nuts
CSP46	8 x 40mm	Set Screws & Nuts
CSP47	8 x 50mm	Set Screws & Nuts
CSP48	10 x 25mm	Set Screws & Nuts
CSP49	10 x 35mm	Set Screws & Nuts
CSP50	10 x 50mm	Set Screws & Nuts
CSP51	5 x 10mm	Socket Head Cap Screws
CSP52	5 x 25mm	Socket Head Cap Screws
CSP53	6 x 16mm	Socket Head Cap Screws
CSP54	6 x 25mm	Socket Head Cap Screws
CSP55	8 x 16mm	Socket Head Cap Screws
CSP56	8 x 25mm	Socket Head Cap Screws
CSP57	10 x 25mm	Socket Head Cap Screws



CSP056M-2 STAINLESS STEEL MERCHANDISER

A carefully selected range of Marine Grade 316/A4 Stainless Steel products, packaged in reusable clam shell with a three price structure. Barcoded for easy identification.

- Self-Tapping Screws
- Machine Screws & Nuts
- Self-Locking Nuts
- Bolts & Nuts UNC
- Dome Nuts

Includes:

- 3 x 56 types of Marine Grade 316/A4 Stainless Steel
- Total of 168 Packs
- Merchandiser Dimensions: 440mm x 900mm



STAINLESS STEEL

Part No. **CSP056M-2**

MERCHANDISER CONTENTS (56 TYPES)

MARINE GRADE 316/A4 STAINLESS STEEL

CSP58	1/4 x 3/4" UNC	Hex Set Screws
CSP59	1/4 x 1" UNC	Hex Set Screws
CSP60	1/4 x 1-1/2" UNC	Hex Set Screws
CSP61	5/16 x 1" UNC	Hex Set Screws
CSP62	5/16 x 1-1/2" UNC	Hex Set Screws
CSP63	3/8 x 1" UNC	Hex Set Screws
CSP64	3/8 x 1-1/2" UNC	Hex Set Screws
CSP65	3/16 x 1/2" UNC	Pan Head Screws
CSP66	3/16 x 3/4" UNC	Pan Head Screws
CSP67	3/16 x 1" UNC	Pan Head Screws
CSP68	3/16 x 1-1/4" UNC	Pan Head Screws
CSP69	3/16 x 1-1/2" UNC	Pan Head Screws
CSP70	3/16 x 2" UNC	Pan Head Screws
CSP71	1/4 x 1/2" UNC	Pan Head Screws
CSP72	1/4 x 3/4" UNC	Pan Head Screws
CSP73	1/4 x 1" UNC	Pan Head Screws
CSP74	1/4 x 1-1/4" UNC	Pan Head Screws
CSP75	1/4 x 1-1/2" UNC	Pan Head Screws
CSP76	1/4 x 2" UNC	Pan Head Screws
CSP77	3/16 x 1/2" UNC	Countersunk Screws
CSP78	3/16 x 1" UNC	Countersunk Screws
CSP79	3/16 x 1-1/4" UNC	Countersunk Screws
CSP80	3/16 x 1-1/2" UNC	Countersunk Screws
CSP81	3/16 x 2" UNC	Countersunk Screws
CSP82	1/4 x 1/2" UNC	Countersunk Screws
CSP83	1/4 x 3/4" UNC	Countersunk Screws
CSP84	1/4 x 1" UNC	Countersunk Screws
CSP85	1/4 x 1-1/4" UNC	Countersunk Screws
CSP86	1/4 x 1-1/2" UNC	Countersunk Screws
CSP87	1/4 x 2" UNC	Countersunk Screws
CSP88	1/4" UNC	Self-Locking Nuts
CSP89	5/16" UNC	Self-Locking Nuts
CSP90	3/8" UNC	Self-Locking Nuts
CSP91	3/16" UNC	Dome Nuts
CSP92	1/4" UNC	Dome Nuts
CSP93	8G x 1-1/4"	Self-Tapping Screws Pan Head
CSP94	10G x 1-1/4"	Self-Tapping Screws Pan Head
CSP95	10G x 1-1/2"	Self-Tapping Screws Pan Head
CSP96	8G x 1/2"	Self-Tapping Screws Countersunk
CSP97	8G x 1-1/4"	Self-Tapping Screws Countersunk
CSP98	10G x 1-1/4"	Self-Tapping Screws Countersunk
CSP99	10G x 1-1/2"	Self-Tapping Screws Countersunk
CSP100	3/16" UNC	Hex Nuts
CSP101	1/4" UNC	Hex Nuts
CSP102	5/16" UNC	Hex Nuts
CSP103	3/8" UNC	Hex Nuts
DN4	4mm	Dome Nuts
DN5	5mm	Dome Nuts
DN6	6mm	Dome Nuts
DN8	8mm	Dome Nuts
DN10	10mm	Dome Nuts
SLN4	4mm	Self-Locking Nuts
SLN5	5mm	Self-Locking Nuts
SLN6	6mm	Self-Locking Nuts
SLN8	8mm	Self-Locking Nuts
SLN10	10mm	Self-Locking Nuts



CHC1 BRASS PACK HOSE CONNECTORS

This wall mounted Brass Fittings merchandiser includes a comprehensive range of Joiners, Barbs and Elbows. Attractively packaged in reusable blisters and barcoded for easy identification.

- Hose Joiners
- 'T' Joiners
- Hose Barbs
- Elbows
- Reducing Bushes
- Sockets

Includes:

- 2 x 49 types of Brass Packs
- Total of 98 Packs
- Merchandiser Dimensions: 400mm x 1100mm (incl. header)



BRASS PACK HOSE CONNECTORS

Part No. **CHC1**

MERCHANDISER CONTENTS (49 TYPES)

BRASS FITTINGS

HC1	3/16"	Brass Hose Joiners
HC2	1/4"	Brass Hose Joiners
HC3	5/16"	Brass Hose Joiners
HC4	3/8"	Brass Hose Joiners
HC5	1/2"	Brass Hose Joiners
HC6	5/8"	Brass Hose Joiners
HC7	3/4"	Brass Hose Joiners
HC8	3/16"	Brass 'T' Joiners
HC9	1/4"	Brass 'T' Joiners
HC10	5/16"	Brass 'T' Joiners
HC11	3/8"	Brass 'T' Fittings
HC12	1/2"	Brass 'T' Fittings
HC13	5/8"	Brass 'T' Fittings
HC14	3/16 x 1/8"	Male Hose Barbs
HC15	1/4 x 1/8"	Male Hose Barbs
HC16	5/16 x 1/8"	Male Hose Barbs
HC17	3/8 x 1/8"	Male Hose Barbs
HC18	3/16 x 1/4"	Male Hose Barbs
HC19	1/4 x 1/4"	Male Hose Barbs
HC20	5/16 x 1/4"	Male Hose Barbs
HC21	3/8 x 1/4"	Male Hose Barbs
HC22	1/2 x 1/4"	Male Hose Barbs
HC23	5/8 x 1/4"	Male Hose Barbs
HC24	5/16 x 3/8"	Male Hose Barbs
HC25	3/8 x 3/8"	Male Hose Barbs
HC26	1/2 x 3/8"	Male Hose Barbs
HC27	5/8 x 3/8"	Male Hose Barbs
HC28	3/8 x 1/2"	Male Hose Barbs
HC29	1/2 x 1/2"	Male Hose Barbs
HC30	5/8 x 1/2"	Male Hose Barbs
HC31	3/4 x 1/2"	Male Hose Barbs
HC32	3/4 x 3/4"	Male Hose Barbs
HC33	1/4 x 1/8"	90° Male Elbows
HC34	5/16 x 1/8"	90° Male Elbows
HC35	1/4 x 1/4"	90° Male Elbows
HC36	5/16 x 1/4"	90° Male Elbows
HC37	3/8 x 1/4"	90° Male Elbows
HC38	1/2 x 1/4"	90° Male Elbows
HC39	5/8 x 1/4"	90° Male Elbows
HC40	5/8 x 3/8"	90° Male Elbows
HC41	1/2 x 1/2"	90° Male Elbows
HC42	5/8 x 1/2"	90° Male Elbows
HC43	1/4 - 1/8"	Hex Reducing Bush
HC44	3/8 - 1/4"	Hex Reducing Bush
HC45	1/2 - 1/4"	Hex Reducing Bush
HC46	1/8"	Hex Sockets
HC47	1/4"	Hex Sockets
HC48	1/8"	Female Brass 'T'
HC49	1/4"	Brass Female 'T'





CHC2 BRASS PACK HOSE CONNECTORS

This wall mountable selection of Brass Fittings complements the CHC1 and offers an extended range of Joiners, Barbs and Elbows. Packaged in reusable blisters and barcoded for easy identification.

- Hose Joiners
- 'T' Joiners
- Hose Barbs
- Elbows
- Reducing Bushes
- Sockets

Includes:

- 2 x 49 types of Brass Packs
- Total of 98 Packs
- Merchandiser Dimensions: 400mm x 1100mm (incl. header)



BRASS PACK HOSE CONNECTORS

Part No. **CHC2**

MERCHANDISER CONTENTS (49 TYPES)

BRASS FITTINGS

HC50	1/8" BSP	Hex Taper Plugs
HC51	1/4" BSP	Hex Taper Plugs
HC52	3/8" BSP	Hex Taper Plugs
HC53	1/2" BSP	Hex Taper Plugs
HC54	1/8" BSP	Hex Nipples
HC55	1/4" BSP	Hex Nipples
HC56	3/8" BSP	Hex Nipples
HC57	1/2" BSP	Hex Nipples
HC58	1/8" BSP	M&F Elbows
HC59	1/4" BSP	M&F Elbows
HC60	3/8 x 1/8" BSP	Reducing Bush
HC61	1/2 x 1/8" BSP	Reducing Bush
HC62	1/2 x 3/8" BSP	Reducing Bush
HC63	3/8" BSP	Hex Sockets
HC64	1/2" BSP	Hex Sockets
HC65	1/4 x 1/8" BSP	Reducing Sockets
HC66	3/8 x 1/8" BSP	Reducing Sockets
HC67	3/8 x 1/4" BSP	Reducing Sockets
HC68	1/2 x 1/4" BSP	Reducing Sockets
HC69	1/2 x 3/8" BSP	Reducing Sockets
HC70	3/4 x 3/8" BSP	Reducing Bush
HC71	3/4 x 1/2" BSP	Reducing Bush
HC72	1/8" BSP	Female Elbows
HC73	1/4" BSP	Female Elbows
HC74	3/8" BSP	Female Elbows
HC75	1/2" BSP	Female Elbows
HC76	1/4 x 1/8" BSP	M&F Adaptors
HC77	1/4 x 1/4" BSP	M&F Adaptors
HC78	3/8 x 1/8" BSP	M&F Adaptors
HC79	3/8 x 1/4" BSP	M&F Adaptors
HC80	3/8 x 3/8" BSP	M&F Adaptors
HC81	1/2 x 1/4" BSP	M&F Adaptors
HC82	1/2 x 3/8" BSP	M&F Adaptors
HC83	1/4 x 1/8" BSP	Reducing Nipples
HC84	3/8 x 1/8" BSP	Reducing Nipples
HC85	3/8 x 1/4" BSP	Reducing Nipples
HC86	1/2 x 1/4" BSP	Reducing Nipples
HC87	1/2 x 3/8" BSP	Reducing Nipples
HC88	3/4 x 1/2" BSP	Reducing Nipples
HC89	3/16 x 1/8"	Female Tailpiece
HC90	1/4 x 1/8"	Female Tailpiece
HC91	5/16 x 1/8"	Female Tailpiece
HC92	3/16 x 1/4"	Female Tailpiece
HC93	1/4 x 1/4"	Female Tailpiece
HC94	5/16 x 1/4"	Female Tailpiece
HC95	3/8 x 1/4"	Female Tailpiece
HC96	1/2 x 1/4"	Female Tailpiece
HC97	3/8 x 3/8"	Female Tailpiece
HC98	1/2 x 3/8"	Female Tailpiece





MTF1 PANEL PACK STAND

This merchandiser features a popular range of specialised Trim Clips, Fasteners and Fittings to service automotive panels and trims. All packaged in reusable clam shells designed to be sold at one price. Barcoded for easy identification.

- Door & Body Trim Clips
- Universal Weather Seal Clips
- Panel Screws & Nuts
- Screw Grommets
- Other Associated Products
- Speed Nuts
- Bonnet Clips
- Moulding Clips
- Headlamp Clips

Includes:

- 3 x 56 types of Trim Clips
- Total of 168 Packs
- Merchandiser Dimensions: 440mm x 960mm (incl. header)



PANEL PACK STAND

Part No. **MTF1**

MERCHANDISER CONTENTS (56 TYPES)

TRIM CLIPS

TF1	Xmas Tree Clips
TF2	Xmas Tree Clips
TF3	Xmas Tree Clips
TF4	Xmas Tree Clips
TF5	Xmas Tree Clips
TF6	Xmas Tree Clips
TF7	Xmas Tree Clips
TF8	Xmas Tree Clips
TF9	Xmas Tree Clips
TF10	Xmas Tree Clips
TF11	Xmas Tree Clips
TF12	Xmas Tree Clips
TF13	Xmas Tree Clips
TF14	Xmas Tree Clips
TF15	Xmas Tree Clips
TF16	Canoe Clips
TF17	Canoe Clips
TF18	Moulding Clips
TF19	Canoe Clips
TF20	Canoe Clips
TF21	Canoe Clips
TF22	Canoe Clips
TF23	Bonnet Insulation Clips
TF24	Anchor Trim Clips
TF25	Retainer Clips
TF26	Plastic Push Rivets
TF27	Scrivet Clips 6mm
TF28	Plastic Push Rivets
TF29	Scrivet Clips 6mm Hole
TF30	Scrivet Clips 8mm Hole
TF31	Screw Rivets
TF32	Splash Guard Clips
TF33	6G Screw Grommets
TF34	8G Screw Grommets
TF35	6G Screw Grommets
TF36	10G Screw Grommets
TF37	Door Trim Clips
TF38	Door Trim Clips
TF39	10mm Universal Door Trim Bush
TF40	13mm Universal Door Trim Bush
TF41	Weather Seal Clips
TF42	Weather Seal Clips
TF43	Universal Moulding Clips
TF44	Commodore Headlight Clips
TF45	Moulding Clips
TF46	Door Trim Bush
TF47	1/8" Self-Cut Nuts
TF48	3/16" Self-Cut Nuts
TF49	Window Winder Clips
TF50	M5 Headlamp Captive Nuts
TF51	M6 Short Captive Nuts
TF52	M8 Short Captive Nuts
TF53	3/8" x 10G Hex Head Sem Assembly
TF54	Hex Head Self-Tapping Screws
TF55	6 x 25mm Flange Heads
TF56	6 x 18mm Hex Head Sem Assembly





MTF2 PANEL PACK STAND

This merchandiser is an increased range of specialised Trim Clips to complement the MTF1 and helps service a larger range of vehicles, including new model vehicles. All packaged in reusable blisters designed to be sold at one price. Barcoded for easy identification.

- Door & Body Trim Clips
- Universal Weather Seal Clips
- Panel Screws & Nuts
- Screw Grommets
- Other Associated Products
- Headlamp Clips
- Speed Nuts
- Bonnet Clips
- Moulding Clips

Includes:

- 3 x 56 types of Trim Clips
- Total of 168 Packs
- Merchandiser Dimensions: 440mm x 960mm (incl. header)



PANEL PACK STAND

Part No. **MTF2**

MERCHANDISER CONTENTS (56 TYPES)

TRIM CLIPS

TF57	Push Rivets
TF58	Push Rivets
TF59	Push Rivets
TF60	Push Rivets
TF61	Push Rivets
TF62	Push Rivets
TF63	Push Rivets
TF64	Push Rivets
TF65	Push Rivets
TF66	Push Rivets
TF67	Push Rivets
TF68	Push Rivets
TF69	Push Rivets
TF70	Push Rivets
TF71	Push Rivets
TF72	Push Rivets
TF73	Push Rivets
TF74	Push Rivets
TF75	Push Rivets
TF76	Push Rivets
TF77	Scrivets
TF78	Push Rivets
TF79	Scrivets
TF80	Scrivets
TF81	Push Rivets
TF82	Push Rivets
TF83	Scrivets
TF84	Scrivets
TF85	Scrivets
TF86	Scrivets
TF87	Xmas Tree Clips
TF88	Xmas Tree Clips
TF89	Xmas Tree Clips
TF90	Xmas Tree Clips
TF91	Xmas Tree Clips
TF92	Xmas Tree Clips
TF93	Canoe Clips
TF94	Screw Grommets
TF95	Screw Grommets
TF96	Screw Grommets
TF97	Screw Grommets
TF98	Screw Grommets
TF99	Screw Grommets
TF100	Screw Grommets
TF101	Screw Grommets
TF102	Door Trim Clips
TF103	Door Trim Clips
TF104	Door Trim Clips
TF105	Trim Anchors
TF106	Grill Clips
TF107	Grill Clips
TF108	Body Mould Clips
TF109	Body Mould Clips
TF110	Body Mould Clips
TF111	Body Mould Clips
TF112	Speed Clips





CSPM1 SCREW PACK MERCHANDISER

This new range of Hardware Screws are ideally suited for use on chipboard, plasterboard and cement sheets.

- Chipboard Screws
- Bugle Head (Fine/Coarse)
- Button Head
- Cement Sheet
- Self-Drilling
- Raised Head Phillips
- Pan x Machine
- Mushroom Head

Includes:

- 3 x 56 types of Screw Packs
- Total of 168 Packs
- Merchandiser Dimensions: 440mm x 960mm (incl. header)



SCREW PACKS

Part No. **CSPM1**

MERCHANDISER CONTENTS (56 TYPES)

SCREW PACKS

SP01	8G x 20G	Chipboard Screws
SP02	8G x 25G	Chipboard Screws
SP03	8G x 32G	Chipboard Screws
SP04	8G x 40G	Chipboard Screws
SP05	8G x 50G	Chipboard Screws
SP06	8G x 57G	Chipboard Screws
SP07	8G x 65G	Chipboard Screws
SP08	10G x 75G	Chipboard Screws
SP09	6G x 20G	Bugle Head Fine
SP10	6G x 25G	Bugle Head Fine
SP11	6G x 32G	Bugle Head Fine
SP12	7G x 30G	Bugle Head Fine
SP13	7G x 40G	Bugle Head Fine
SP14	7G x 50G	Bugle Head Fine
SP15	8G x 65G	Bugle Head Fine
SP16	8G x 75G	Bugle Head Fine
SP17	7G x 25G	Bugle Head Coarse
SP18	7G x 30G	Bugle Head Coarse
SP19	7G x 40G	Bugle Head Coarse
SP20	8G x 20G	Button Head
SP21	8G x 25G	Button Head
SP22	8G x 32G	Button Head
SP23	8G x 20G	Cement Sheet
SP24	8G x 30G	Cement Sheet
SP25	8G x 12G	Self-Drilling
SP26	8G x 16G	Self-Drilling
SP27	8G x 20G	Self-Drilling
SP28	8G x 25G	Self-Drilling
SP29	10G x 16G	Self-Drilling
SP30	10G x 22G	Self-Drilling
SP31	10G x 30G	Self-Drilling
SP32	10G x 16G	Self-Drilling Hex
SP33	6G x 1/2"	Raised Head Phillips
SP34	6G x 3/4"	Raised Head Phillips
SP35	6G x 1"	Raised Head Phillips
SP36	8G x 3/4"	Raised Head Phillips
SP37	8G x 1"	Raised Head Phillips
SP38	8G x 1-1/2"	Raised Head Phillips
SP39	10G x 3/4"	Raised Head Phillips
SP40	10G x 1"	Raised Head Phillips
SP41	4 x 16mm	Pan x Machine
SP42	4 x 25mm	Pan x Machine
SP43	5 x 16mm	Pan x Machine
SP44	5 x 25mm	Pan x Machine
SP45	6 x 16mm	Pan x Machine
SP46	6 x 20mm	Pan x Machine
SP47	6 x 25mm	Pan x Machine
SP48	6 x 50mm	Pan x Machine
SP49	3/16 x 1/2"	Mushroom Head
SP50	3/16 x 3/4"	Mushroom Head
SP51	3/16 x 1"	Mushroom Head
SP52	3/16 x 1-1/2"	Mushroom Head
SP53	1/4 x 3/4"	Mushroom Head
SP54	1/4 x 1"	Mushroom Head
SP55	1/4 x 1-1/4"	Mushroom Head
SP56	1/4 x 1-1/2"	Mushroom Head

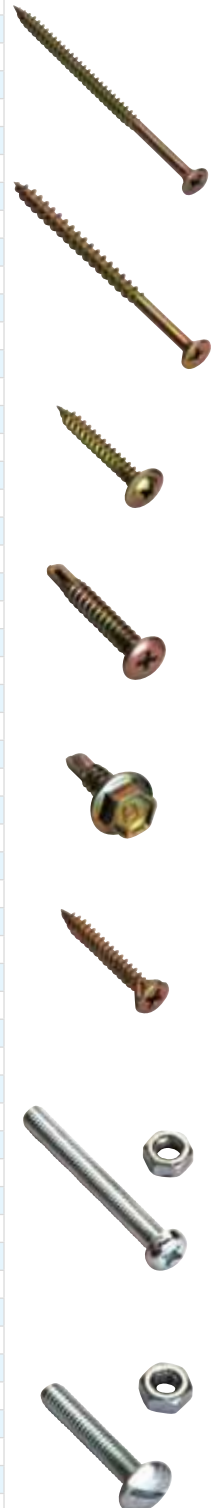



CRTPM1 CRIMP TERMINALS

This selection of crimp terminals is made of the most popular, fast moving terminals, to cover a wide demographic of customers. This wall merchandiser is suitable for automotive, hardware and industrial applications.

- Spade Terminals M&F
- Blade Terminals M&F
- Bullet in M&F Joiners
- 2 Way Piggy Back M&F
- Eye M&F

Includes:

- 5 x 49 types of Terminal Packs
- Total of 245 Packs
- Merchandiser Dimensions: 1150mm x 385mm (incl. header)



CRIMP TERMINALS

Part No. **CRTPM1**

MERCHANDISER CONTENTS (49 TYPES)

CRIMP TERMINALS

KSB-6	Blue Wire Tap Connectors
KSR-6	Red Wire Tap Connectors
R13-4	4mm Red Ring Terminals
R13-5	5mm Red Ring Terminals
R13-6	6mm Red Ring Terminals
R1320FB	Non Insulated Blade Terminals Female
R1320MB	Non Insulated Blade Terminals Male
R13Y-4	4mm Red Spade Terminals
R200F	Red Bullet Terminals Female
R200M	Red Bullet Terminals Male
R201F	Blue Bullet Terminals Female
R201M	Blue Bullet Terminals Male
R202F	Yellow Bullet Terminals Female
R202M	Yellow Bullet Terminals Male
R22-5	3/16" Blue Ring Terminals
R22Y-4	Blue Spade Terminals
R23-10	10mm Blue Ring Terminals
R23-6	15/64" Blue Ring Terminals
R23-8	5/16" Blue Ring Terminals
R309F	Red Blade Terminals Female
R309M	Red Blade Terminals Male
R309WF	Red Fully Insulated Blade Term. M/F
R309WM	Red Blade Terminals Male
R320F	Blue Blade Terminals Female
R320M	Blue Blade Terminals Male
R320WF	Blue Fully Insulated Blade Terminals
R320WM	Blue Fully Insulated Blade Terminals
R355F	Yellow Blade Terminals Female
R355M	Yellow Blade Terminals Male
R355WF	Yellow Full. Insul. Blade Terminal Female
R383FM	Red 2-Way Blade Terminals M/F
R384FM	Blue 2-Way Blade Terminals M/F
R385F	Blue Blade Terminals Female
R386F	10mm Yellow Blade Terminals Female
R509F	Red Speaker Blade Terminals M/F
R509M	Red Speaker Blade Terminals Male
R52-4	4mm Yellow Ring Terminals
R52-5	5mm Yellow Ring Terminals
R520F	Red Spade Terminals Female
R520M	4.8mm Red Blade Terminals Male
R520WF	5mm Red Blade Terminals Female
R52Y-5	Yellow Spade Terminals
R53-6	6mm Yellow Ring Terminals
R53-8	8mm Yellow Ring Terminals
R55-10	10mm Yellow Ring Terminals
R55-13	13mm Yellow Ring Terminals
RTG-1	Red Cable Connectors
RTG-2	Blue Cable Connectors
RTG-3	Yellow Cable Connectors





HP049 HANDY PACK WALL MERCHANDISER

This wall merchandiser has a range of popular Handy Packs suitable for any industry including automotive, hardware and industrial or fastener outlets.

- Self-Tapping Screws
- Split Pins
- Flat Steel Washers
- Trim Clips
- Other Associated Products
- Speed Nuts
- Aluminium Rivets
- Body Washers
- Wiring Grommets

Includes:

- 5 x 49 types of Trim Clips
- Total of 245 Packs
- Merchandiser Dimensions: 400mm x 1100mm (incl. header)

Champion
FASTENERS

HANDY PACKS

Part No. **HP049**

MERCHANDISER CONTENTS (49 TYPES)

HANDY PACKS

BH004	5/16 x 17/32"	Rubber Wiring Grommets
BH006	3/8 x 5/8"	Rubber Wiring Grommets
BH017	5/16"	Rubber Blanking Grommets
BH019	1/2"	Rubber Blanking Grommets
BH090	3/16 x 1/2"	Roof Bolts & Nuts
BH091	3/16 x 3/4"	Roof Bolts & Nuts
BH093	3/16 x 1-1/2"	Roof Bolts & Nuts
BH094	1/4 x 3/4"	Roof Bolts & Nuts
BH097	8G x 31/32 x 7/16"	Speed Nuts
BH099	6G x 21/32 x 7/16"	Speed Nuts
BH103	3/16 x 5/8 x 3/8"	Speed Nuts
BH121	8G x 1"	Self-Tapping Screws Pan Head
BH125	14G x 3/4"	Self-Tapping Screws Pan Head
BH151	6G x 3/8"	Self-Tapping Screws Pan Head
BH152	8G x 1/2"	Self-Tapping Screws Pan Head
BH153	10G x 1/2"	Self-Tapping Screws Pan Head
BH166	12G x 1"	Self-Tapping Screws Pan Head
BH170	3/16"	Flat Steel Washers
BH171	1/4"	Flat Steel Washers
BH172	5/16"	Flat Steel Washers
BH173	3/8"	Flat Steel Washers
BH178	1.6 x 22mm	Split Pins
BH180	2 x 36mm	Split Pins
BH182	2.5 x 32mm	Split Pins
BH184	7/64 x 1-1/4"	Split Pins
BH186	3.2 x 50mm	Split Pins
BH187	9/64 x 2"	Split Pins
BH188	4 x 50mm	Split Pins
BH226	1/4 x 1-1/4"	Panel (body) Washers
BH227	5/16 x 1-1/4"	Panel (body) Washers
BH228	3/8 x 1-1/4"	Panel (body) Washers
BH328	1/4"	Spring Washers
BH329	5/16"	Spring Washers
BH330	3/8"	Spring Washers
BH425	8.2 to 8.4mm Hole Size	Canoe Black Trim Clips
BH426	6.6 to 7.8mm Hole Size	Canoe Brown Trim Clips
BH437	6.6 to 7.5mm Hole Size	Xmas Tree Clip, Black Trim Clips
BH620	4 x 10mm	Metric Machine Screws
BH621	5 x 16mm	Metric Machine Screws
BH624	6 x 20mm	Metric Machine Screws
BH721	1/8" Medium	Aluminium Rivets
BH724	5/32" Medium	Aluminium Rivets
BH727	3/16" Medium	Aluminium Rivets
BH732	6G x 3/4"	Self-Tapping Screws Black Zinc
BH733	6G x 1"	Self-Tapping Screws Black Zinc
BH734	8G x 3/8"	Self-Tapping Screws Black Zinc
BH735	8G x 5/8"	Self-Tapping Screws Black Zinc
BH736	8G x 3/4"	Self-Tapping Screws Black Zinc
BH737	8G x 1"	Self-Tapping Screws Black Zinc



AFB32

AIR-LINE FITTINGS

A popular range of 31 Air Fittings that interchange with Nitto, Ryco or Jamec and comprises of 1/4" to 1/2" sizes. Male and Female Couplings complete with matching Barb and Threaded Nipples, Adaptors, 2 Way Manifolds and In-Line Regulators.

- Nitto Interchange
- Ryco Interchange
- Jamec Interchange
- Universal

Includes:

- 3 x 31 types of Air-Line Fittings
- Total of 93 Packs (plus 2 In-Line Pressure Regulators)
- Merchandiser Dimensions: 400mm x 1100mm (incl. header)

Champion
FASTENERS

AIR-LINE FITTINGS

Part No. **AFB32**

MERCHANDISER CONTENTS (31 TYPES)

NITTO INTERCHANGE

B420MC	1/4" Male Coupling
B420FC	1/4" Female Coupling
B430HC	3/8" Hose Barb Coupling
B420MN	1/4" Male Nipple
B420FN	1/4" Female Nipple
B425H	5/16" Hose Barb Nipple
B430H	3/8" Hose Barb Nipple
B440H	1/2" Hose Barb Nipple



RYCO INTERCHANGE

B200	1/4" Female Coupling
B201	1/4" Male Coupling
B241	3/8" Hose Barb Coupling
B202	1/4" Male Nipple
B203	1/4" Female Nipple
B206	5/16" Hose Barb Nipple
B208	3/8" Hose Barb Nipple



JAMEC INTERCHANGE

B310M	1/4" Male Coupling
B310F	1/4" Female Coupling
B310T	3/8" Hose Barb Coupling
B31M	1/4" Male Nipple
B31F	1/4" Female Nipple
B315B	5/16" Hose Barb Nipple
B316B	3/8" Hose Barb Nipple



UNIVERSAL

B207B	1/4" Male x 1/4" Hose Barb
B208B	1/4" Male x 5/16" Hose Barb
B209B	1/4" Male x 3/8" Hose Barb
B238	1/4" Female x 3/8" Hose Barb
B2403	3/8" Male X 1/4" Female Reducer
B2702	1/4" x 1/4" Male Adaptor
B3502	1/4" 3-Way Female 'T' Joiner
BMP2	1/4" 2-Way Manifold
BTC4	1/4" Female Tyre Chuck
BREG02	1/4" Inline Regulator





CTRM25 THREAD COIL INSERTS

A range of Metric, UNF and UNC Thread Coil Inserts are included in this wall mounted Merchandiser. Packs include coils of various lengths of commonly used sizes.

- High Quality Stainless Steel
- Interchangeable with other brands

Includes:

- 3 x 25 types of Thread Coil Inserts
- Total of 75 Packs
- Merchandiser Dimensions: 390mm x 690mm (incl. header)



THREAD COIL INSERTS

Part No. **CTRM25**

*High Quality
Stainless Steel*



MERCHANDISER CONTENTS (25 TYPES)

THREAD COIL INSERTS

CTRM587	M5 x 0.8 x 7mm	
CTRM603	M6 x 1.00 x 3mm	
CTRM606	M6 x 1.00 x 6mm	
CTRM609	M6 x 1.00 x 9mm	
CTRM805	M8 x 1.25 x 5mm	
CTRM808	M8 x 1.25 x 8mm	
CTRM812	M8 x 1.25 x 12mm	
CTRM101507	M10 x 1.50 x 7mm	
CTRM1015010	M10 x 1.50 x 10mm	
CTRM1015015	M10 x 1.50 x 15mm	
CTRM101257	M10 x 1.25 x 7mm	
CTRM1012510	M10 x 1.25 x 10mm	
CTRM1012515	M10 x 1.25 x 15mm	
CTRM121755	M12 x 1.75 x 5mm	
CTRM121758	M12 x 1.75 x 8mm	
CTRM1217511	M12 x 1.75 x 11mm	
CTRC44	1/4 UNC x 4mm	
CTRC46	1/4 UNC x 6mm	
CTRC48	1/4 UNC x 8mm	
CTRC55	5/16 UNC x 5mm	
CTRC59	5/16 UNC x 9mm	
CTRC512	5/16 UNC x 12mm	
CTRC67	3/8 UNC x 7mm	
CTRC611	3/8 UNC x 11mm	
CTRC616	3/8 UNC x 16mm	

THREAD REPAIR KITS

CTRKMET-5 METRIC THREAD REPAIR SET

- Inserts suitable for all applications
- Made from high quality Stainless Steel
- Interchangeable with other brands
- Thread Coil Insert packs on previous page double as refills for these assortments



Assortment Includes:

Tap
Drill
Installation Tool
Thread Inserts
Break-Off Tool

Insert Sizes:

M5 x 0.8
M6 x 1.00
M8 x 1.25
M10 x 1.50
M12 x 1.75

Thread Coil Insert packs on previous page double as refills for these assortments

THREAD INSERT REPAIR KIT Includes: Tap, Drill Bit, Installation Tool, Break-off Tool and Thread Inserts. 12 Pieces (varying lengths)



*12 Piece Kit
available in
Imperial & Metric*

Thread Coil Insert packs on previous page double as refills for these assortments

STAINLESS STEEL IMPERIAL

PART No.	SIZE
CTRK3NC	3/16" UNC
CTRK4NC	1/4" UNC
CTRK5NC	5/16" UNC
CTRK6NC	3/8" UNC
CTRK3NF	3/16" UNF
CTRK4NF	1/4" UNF
CTRK5NF	5/16" UNF
CTRK6NF	3/8" UNF

STAINLESS STEEL METRIC

PART No.	SIZE
CTRK508	5mm x 0.8mm
CTRK6100	6mm x 1.00mm
CTRK8125	8mm x 1.25mm
CTRK10150	10mm x 1.50mm
CTRK10125	10mm x 1.25mm



DRAIN (SUMP) PLUGS

Part No. **CDP1**

A popular selection of Steel Drain (Sump) Plugs, complemented by a range of the most popular Seals and Washers. Packaged in reusable clamshells. Merchandiser is wall mounted.

Includes:

- 3 x 12 types of Drain (Sump) Plugs
- Total of 36 Packs
- Merchandiser Dimensions: 500H x 200W x 120D mm (incl. header)

CDP1 DRAIN (SUMP) PLUGS

MERCHANDISER CONTENTS (12 TYPES)

CDP02	No.1	1/2" UNF Plug
CDP03	No.10/S	1/2+ .028" Plug
CDP04	No.3	5/8" UNF Plug
CDP05	No.16	3/8" BSPP Plug
CDP06	No.12	M12 x 1.5 Plug
CDP07	No.12F	M12 x 1.25 Plug
CDP08	No.14	M14 x 1.5 Plug
CDP09	No.18	M18 x 1.5 Plug
CDP10	No.25	M25 x 1.5 Plug
CDP11		Copper Washers to suit Plugs
CDP12		Aluminium Washers to suit Plugs
CDP13		Fibre Washers to suit Plugs



LINKAGE BALL JOINTS

Part No. **CL1**

A popular selection of steel, threaded Ball Joints. This range of linkages has been carefully selected to cover automotive and agricultural applications. All linkages are zinc plated for corrosion resistance. Merchandiser is wall mounted.

Includes:

- 3 x 12 types of Ball Joints
- Total of 36 Packs
- Merchandiser Dimensions: 500H x 200W x 120D mm (incl. header)

CL1 LINKAGE BALL JOINTS

MERCHANDISER CONTENTS (12 TYPES)

CL02	3/16" UNF (5mm) 90° Ball Joint Link
CL03	1/4" UNF 90° Ball Joint Link
CL04	5/16" UNF 90° Ball Joint Link
CL05	3/8" UNF 90° Ball Joint Link
CL06	3/16" (5mm) UNF Spring Loaded Link
CL07	1/4" UNF Spring Loaded Link
CL08	5/16" UNF 90° Spring Loaded Link
CL09	1/4" UNC 90° Light Weight Link
CL10	1/4" UNF 90° Light Weight Link
CL11	1/4" UNC In-Line Ball Joint Link
CL12	1/4" UNF In-Line Ball Joint Link
CL13	5/16" UNF Damper Control Link





CBBM75 BLISTER ASSORTMENTS

A popular selection of top quality specialist products conveniently packaged in reusable blisters. Merchandiser is wall mounted.

Includes:

- 3 x 25 types of Assortment Packs
- Total of 75 Packs
- Merchandiser Dimensions: 400mm x 700mm (incl. header)

Champion
FASTENERS

BLISTER ASSORTMENTS

Part No. **CBBM75**

MERCHANDISER CONTENTS (25 TYPES)

ASSORTMENT PACKS

CBB1	Clevis Pins	6 Sizes: 1/4" to 3/8" O.D.
CBB2	'R' Clips	5 Sizes: 3/16" to 7/16" Shaft Dia.
CBB3	Roll Pins	7 Sizes: 2mm to 5mm O.D.
CBB4	'O' Rings	11 Sizes: 3/16" to 1" I.D.
CBB5	'O' Rings	11 Sizes: 5mm to 25mm I.D.
CBB7	Grub Screws	6 Sizes: 5mm to 8mm Dia.
CBB8	Fibre Washers	5 Sizes: Suits Most Applications
CBB9	Circlips	14 Sizes: 1/2" to 1" (Ext. / Int.)
CBB10	'E' Clips	9 Sizes: Suits 1/8" to 5/8" Shaft
CBB11	Drain (Sump) Plugs	Washers Assorted Types
CBB12	Blade Fuses	8 Types: 3 to 30 Amp.
CBB13	Shaft Rings	Suits Shafts: 4mm to 12mm
CBB14	Screws	Suits Shafts: 6G to 10G
CBB15	Terminals	Male/Female & Joiner Crimp Terminals
CBB16	Grease Nipples	Metric 6mm
CBB17	Grease Nipples	Imperial 1/4" UNF
CBB18	Mini Blade Fuses	8 Types: 3 to 30 Amp.
CBB19	Glass Fuses	7 Types: 3 to 20 Amp.
CBB20	Wiring Grommets	8 Sizes: 1/8" to 7/16" Hole Size
CBB21	Blanking Grommets	8 Sizes: 5/16" to 1-1/8" Panel Hole
CBB23	Split Pins	5 Sizes: 1.6mm to 3.2mm Dia.
CBB24	Spring Washers	4 Sizes: 3/16" to 3/8"
CBB27	Screw Grommets	3 Sizes: 6G to 10G
CBB28	Clips	Canoe Xmas Tree Clips
CBB31	Screws	Anti-Theft Screws



Self-Tapping Thread Inserts with Internal and External Threads
Merchandiser Dimensions: 350mm x 450mm (incl. header)

Champion
FASTENERS

THREAD INSERTS

Part No. **CTM36**

CTM36 THREAD INSERTS

MERCHANDISER CONTENTS (12 TYPES x 3 PACKS OF EACH)

CTI-05	2 qty	5mm	<i>Additional packs also available:</i>		
CTI-06	2	6mm			
CTI-08	2	8mm	CTI-10125	1 qty	10 x 1.25mm
CTI-10	2	10mm	CTI-12125	1	12 x 1.25mm
CTI-140	1	14 x 1.25mm Short	CTI-12150	1	12 x 1.50mm
CTI-141	1	14 x 1.25mm Long	CTI-12	1	12mm
CTI-625	2	1/4" UNC	CTI-644	1	7/16" UNC
CTI-631	2	5/16" UNC	CTI-744	1	7/16" UNF
CTI-637	2	3/8" UNC	Thread inserts are used to repair damaged or stripped threads, and may be used to create new threads.		
CTI-725	2	1/4" UNF			
CTI-731	2	5/16" UNF			
CTI-737	2	3/8" UNF			

CLAMSHELL BLISTER ASSORTMENTS

A popular selection of top quality specialist products conveniently packaged in reusable clamshells. Ideal for the home, workshop or industrial application.



CBB1 CLEVIS PINS

- 6 Sizes: Imperial
- 1/4" to 3/8" O.D.
- 6 Pieces



CBB2 'R' CLIPS

- 5 Sizes: Imperial
- 3/16" to 7/16" Shaft Dia.
- 8 Pieces



CBB3 ROLL PINS

- 7 Sizes: Metric
- 2mm to 5mm O.D.
- 14 Pieces



CBB4 'O' RINGS

- 11 Sizes: Imperial
- 3/16" to 1" I.D.
- 22 Pieces



CBB5 'O' RINGS

- 11 Sizes: Metric
- 5mm to 25mm I.D.
- 22 Pieces



CBB6 GRUB SCREWS

- 8 Sizes: Imperial
- 3/16" to 3/8" Dia. UNC
- 16 Pieces



CBB7 GRUB SCREWS

- 6 Sizes: Metric
- 5mm to 8mm Dia.
- 12 Pieces



CBB8 SUMP PLUG WASHERS

- Fibre
- 5 Sizes: Suits most applications
- 10 Pieces



CBB9 CIRCLIPS

- 14 Sizes: Imperial
- 1/4" to 1" Ext. • 1/2" to 1" Int.
- 19 Pieces



CBB10 'E' CLIPS

- 9 Sizes: Imperial
- Suits 1/8" to 5/8" Shafts
- 16 Pieces



CBB11 SUMP PLUG WASHERS

- Copper/Aluminium
- 6 Sizes: Suits most applications
- 9 Pieces



CBB12 BLADE FUSES

- AF Type
- 8 Sizes: 3 Amp. to 30 Amp.
- 8 Pieces



CBB13 SHAFT RINGS

- Metric
- Suits Shafts: 4mm to 12mm
- 12 Pieces



CBB14 SPEED NUTS

- Imperial
- Suits Shafts: 6G to 10G Screws
- 14 Pieces



CBB15 CRIMP TERMINALS

- Male/Female & Joiner
- 12 Pieces



CBB16 GREASE NIPPLES

- 11 Sizes: Imperial
- 3/16" I.D.
- 6 Pieces



CBB17 GREASE NIPPLES

- 11 Sizes: Imperial
- 3/16" I.D.
- 4 Pieces



CBB18 MINI BLADE FUSES

- AF Type
- 8 Sizes: 3 Amp. to 30 Amp.
- 8 Pieces



CBB19 GLASS FUSES

- 7 Sizes: 3 Amp. to 30 Amp.
- 7 Pieces



CBB20 WIRING GROMMETS

- 8 Sizes: Imperial
- Hole Size: 1/8" to 7/16"
- 8 Pieces



CBB21 BLANKING GROMMETS

- 8 Sizes: Imperial
- Panel Hole Size: 5/16" to 1-1/8"
- 8 Pieces



CBB22 EXTENSION SPRINGS

- 4 Sizes: Imperial
- Lengths to 2"
- 8 Pieces



CBB23 SPLIT PINS

- 5 Sizes: Metric
- 1.6mm to 3.2mm Dia.
- 25 Pieces



CBB24 SPRING WASHERS

- 4 Sizes: Imperial
- 3/16" to 3/8"
- 20 Pieces



CBB25 STAR WASHERS

- 8 Sizes: Imperial
- 3/16" to 3/8" Int. & Ext.
- 16 Pieces



CBB26 BLK S/TAPPING SCREWS

- Black Self-Tapping Screws
- 6 Sizes: 6G to 8G. Lengths to 1"
- 12 Pieces



CBB27 SCREW GROMMETS

- 3 Sizes: 6G to 10G
- 6 Pieces



CBB28 TRIM CLIPS

- Canoe / Xmas Tree Clips
- 4 Pieces



CBB31 ANTI-THEFT SCREWS

- Anti-Theft Number Plate Screws
- Suits most vehicles
- 30 Pieces

Anti-Theft, Number Plate Screws

This pack is designed to suit most vehicle applications to stop number plate theft.

Each pack contains one size of Self-Tapping Screws and one size of Machine Screws, complete with Nuts.

THREAD LOCK MERCHANDISER

TL262-15 **THREAD LOCK MERCHANDISER** Includes 1 x Hanger and 15 x Thread Lock Blisters

- This display hanger allows use of the Bolt and Nut Stand to offer the Champion Thread Lock to potential customers without taking up valuable wall space.
- Simply attaches to existing stand
- For automotive and industrial applications
- Nuts and bolts may be removed after curing
- Stops threaded fasteners from loosening through vibration
- Helps prevent corrosion
- High viscosity and high strength
- Oil resistant
- Cures in the absence of air

Merchandiser dimensions:
1100H x 125W x 60D (mm)

Holds a total of 25 blisters
5 blisters per peg



CSS1 **SHIM MERCHANDISER**

- Contains: 3 rolls x CA31 Shim Brass and 3 rolls x CA33 Shim Steel
- Size Range: .002, .003, .006, .010
- Length Range: 600mm x 900mm
- Merchandiser Dimensions: 400H x 250W (mm) incl. header



DPM1 **DRAIN PLUG MERCHANDISER**

- Full selection of Imperial and Metric Drain Plugs
- Easy identification of plug sizes
- DP1 x 8, DP10S x 16, DP3 x 7, DP12 x 8, DP12F x 8, DP14 x 7, DP16 x 7, DP18 x 4, DP25 x 3.

ANTI-THEFT NUMBER PLATE SCREWS

CBB31-12 ANTI-THEFT NUMBER PLATE SCREWS *Counter Display*

- High profile, self-explanatory display is provided
- As fuel prices climb, so does number plate theft
- One-way screws
- Secures safety signs
- Suits most vehicles
- Also suitable for caravans, trailers, motorcycles, trucks and more.
- Counter display contains a total of 12 blister packs

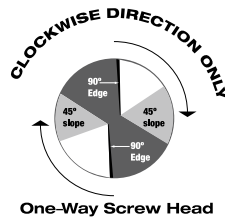

HELPS PREVENT FUEL THEFT

CBB31 ANTI-THEFT NUMBER PLATE SCREWS *Blister Pack*

Each blister pack contains:

- 10 x One-Way Machine Screws
- 10 x 6mm Nuts
- 10 x One-Way Self-Tapping Screws

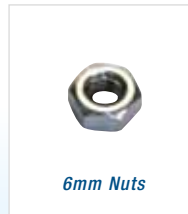
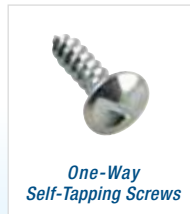

CA214 STAINLESS FASTENER KIT GRADE 304 & 316

- 52 sizes, 210 pieces
- Machine Screws and Nuts: Pan, Countersunk and Phillips Head.
- Self-Tapping Screws: Pan, Countersunk and Phillips Head.
- Hex Head Set Screws and Nuts. Metric ISO.
- Nuts Hex, Standard and Self-Locking. Imperial and Metric.
- Split Pins
- Washers: Flat, Spring and Panel

MISCELLANEOUS PRODUCTS

UNIVERSAL GREASE GUN HOSE *High pressure, flexible, suitable for use with most grease guns*



Part No. R4100X 12" – 254mm O/A Length **Part No. R4101X** 18" – 457mm O/A Length **Part No. R4201X** 24" – 610mm O/A Length

KH100 HYDRAULIC GREASE GUN COUPLER

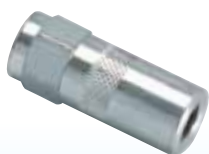

- 1/8" BSP Thread (as widely used throughout Australia)
- Strong positive grip on all grease nipples

05-037 GREASE INJECTOR NEEDLE

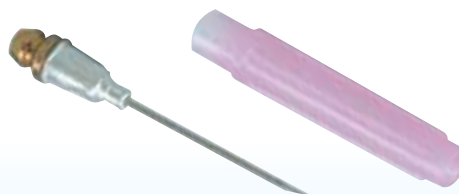

- Connects directly to any grease gun connector
- Lubricates into very tight places (ie: universal joints, sealed bearings)
- 40mm long stainless steel needle
- Suitable for use with handy guns only

VALVE GRINDERS



CVG12	25 pack	3/4" Cup and Handle
CVG13	25 pack	1" Cup and Handle
CVG14	10 pack	1-1/2" Cup and Handle
CVG12A	25 pack	3/4" Cups Only
CVG13A	25 pack	1" Cups Only
CVG14A	10 pack	1-1/2" Cups Only
CVG21	Combination Set: 1 Cup of each size & 1 Handle	

'D' SHACKLES GALVANISED

DSG6	6mm 'D' Shackle GALV
DSG8	8mm 'D' Shackle GALV
DSG10	10mm 'D' Shackle GALV
DSG12	12mm 'D' Shackle GALV

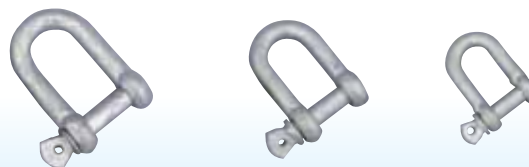

BOW SHACKLES GALVANISED

BSG8	8mm Shackle - BOW GALV
BSG12	12mm Shackle - BOW GALV



H2033-2 NUT RIVET GUN

*Suits M5, M6, M8
and M10 Nut Inserts*



- For professional use in construction and industrial applications
- Two hand grip gives large riveting capacity
- Draw-rod with compound action for quick loading and unloading
- Supplied in carry case

RT6834 TRIM CLIP REMOVER TOOL



- Removes trim clips in just a few seconds

THREAD GAUGE

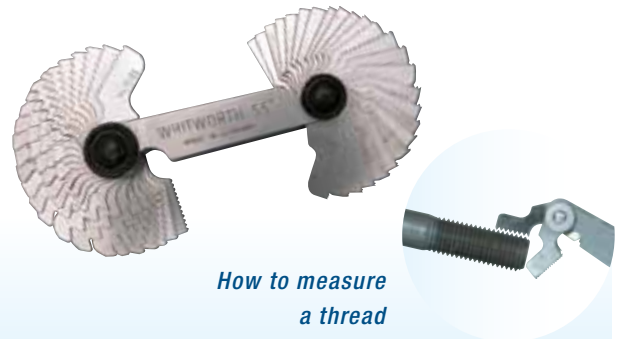

- | | |
|------------|--|
| 137 | BSW, 55° Pitch Angle, Leaves 4 to 62 TPI |
| 156 | Metric, 60° Pitch Angle, 20 Leaves |
| 126 | Combination Metric / Imperial |

BALL JOINTS

The range of Linkage Ball Joints conform fully to SAE Standards
Zinc plated for maximum corrosion protection



SPRING LOADED 90°

- | | |
|--------------|------------|
| A1000 | 10/32" UNF |
| A1002 | 1/4" UNF |
| A1003 | 5/16" UNF |

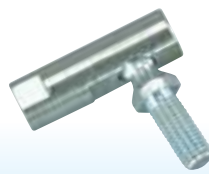

HEAVY DUTY 90°

- | | |
|---------------|------------|
| SP1000 | 10/32" UNF |
| SP1002 | 1/4" UNF |
| SP1003 | 5/16" UNF |
| SP1004 | 3/8" UNF |



LIGHT WEIGHT 90°

- | | |
|---------------|----------|
| D1209C | 1/4" UNC |
| D1209F | 1/4" UNF |

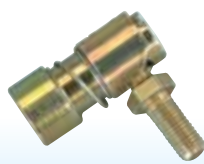

QUICK DISCONNECT 90°

- | | |
|---------------|----------|
| SS1002 | 1/4" UNF |
|---------------|----------|



DAMPER CONTROL

- | | |
|----------------|-----------|
| DC1310F | 5/16" UNF |
|----------------|-----------|



LIGHT WEIGHT IN-LINE

- | | |
|----------------|----------|
| DS1209C | 1/4" UNC |
| DS1209F | 1/4" UNF |

MISCELLANEOUS PRODUCTS



MULTI-PURPOSE USE
*Seals all threaded surfaces,
 preventing parts
 vibrating loose.*

TL262 THREAD LOCK

- Stops threaded fasteners from loosening through vibration
- Especially made to lock all Champion and other threaded fasteners
- Helps prevent corrosion
- High viscosity and high strength
- Oil resistant
- Cures in the absence of air
- Nuts and bolts may be removed after curing
- For automotive and industrial applications



IDEAL FOR:
*screws, bolts, nails,
 sliding drawers,
 latches, and applications
 when a non-greasy
 lubricant is required.*

CTLS1 THREAD LUBE STICK

- Thread lube is a solid lubricating stick for household and industrial applications
- Ideal for freeing jammed drawers, windows etc.
- Enables screws and bolts to screw in easier
- Can be applied to nails and zippers
- Does not stain and is safe to handle
- Easy to use
- Apply lightly to a clean surface



CBH34 BATTERY HYDROMETER

This economical glass hydrometer features an acid resistant rubber bulb with extra long tip and easy to read float scale.



THREAD TESTER:
*Metric
 UNC Coarse
 UNF Fine*

SUITABLE FOR:
*Workshop
 Sales Counter
 Tafe College*

SIZE:
930H x 110W (mm)

CAN BE WALL MOUNTED

TT1 THREAD TESTER

- A unique thread tester panel which enables accurate identification of:
- Thread type
 - Diameter
 - Pitch and length for both bolts and nuts

MISCELLANEOUS PRODUCTS



CSD4
305H x 410W x 320D

CSD6
430H x 410W x 320D

CSD4 4 DRAWER METAL CABINET

CSD6 6 DRAWER METAL CABINET

- Available in either 4 or 6 drawer capacity
- These sturdy metal cabinets are complete with roll out trays
- Attractively powder coated in red to complement the master kits



CDS10 HEAVY DUTY WIRE MERCHANDISER

- Designed to hold four Master Kits
- Merchandiser dimensions: 405H x 185W x 400D (mm)
- Black powder coated
- Sturdy metal frame
- Ideal workshop accessory

LOCKABLE



900H x 640W x 600D (mm)

CSD200 8 DRAWER STORAGE CABINET

25 FIXED COMPARTMENTS per drawer

CSD256 8 DRAWER STORAGE CABINET

UP TO 32 ADJUSTABLE COMPARTMENTS per drawer

- These sturdy metal cabinets are complete with roll out trays
- Ideal for workshops
- Display of small parts in store
- Neatly stocking small parts behind the counter



CDS03 10 TIER ASSORTMENT STAND

- 685H x 190W x 200D (mm) including header
- Stand can be purchased empty or built with your selection of assortments
- Free standing or wall mounted

Storage cabinets and racks are not supplied with assortments

MISCELLANEOUS PRODUCTS



CASE OF BOLTS

CBA1 IMPERIAL – CASE OF BOLTS

A carefully selected range of UNC and UNF, High Tensile, Grade 5, Bolts and Set Screws with Nuts to suit.

- Size Range: 1/4", 5/16", 3/8", 7/16" and 1/2"
- Lengths: up to 4"
- 38 Sizes
- 600 Pieces

CMA1 METRIC – CASE OF BOLTS

A comprehensive range of High Tensile, Grade 8.8, Bolts and Set Screws with Nuts. This assortment has been designed to cover extensive applications on local and imported machinery, vehicles and other equipment.

- Size Range: M5 to M16 Dia.
- Lengths: up to 120mm
- 37 Sizes
- 600 Pieces

CFM1 SPECIAL PITCH – METRIC CASE OF BOLTS

A comprehensive range of Fine Pitch, Metric, High Tensile, Grade 8.8, Hexagon Bolts and Set Screws with Nuts to suit. This assortment has been designed to cover extensive applications on local and imported machinery, vehicles and other equipment.

- Thread Sizes: M6 x 1.0, M8 x 1.0, M10 x 1.0, M8 x 1.25, M10 x 1.25, M12 x 1.25 and M12 x 1.5
- Lengths: up to 120mm
- 39 Sizes with Standard and Flange Nuts
- 600 Pieces



BUCKET OF BOLTS

BBIMP IMPERIAL – BUCKET OF BOLTS

25 qty	1/4 x 5/8" Set Screws	Imperial, H/T, GR5, Hex Nuts, Flat Washers and Spring Washers to suit.
25	1/4 x 3/4" Set Screws	
25	1/4 x 1" Set Screws	
15	1/4 x 1-1/2" Hex Bolts	
10	1/4 x 2-1/4" Hex Bolts	
20	5/16 x 3/4" Set Screws	
15	5/16 x 1-1/4" Hex Bolts	
10	5/16 x 1-1/2" Set Screws	
10	5/16 x 2" Hex Bolts	
10	3/8 x 3/4" Set Screws	
10	3/8 x 1" Set Screws	
10	3/8 x 1-1/4" Set Screws	
5	3/8 x 1-1/2" Hex Bolts	
5	3/8 x 2" Set Screws	
5	3/8 x 2-1/2" Set Screws	
3	7/16 x 1-3/4" Set Screws	
4	7/16 x 1-3/4" Hex Bolts	
8	7/16 x 2" Hex Bolts	
8	1/2 x 1-1/4" Set Screws	
5	1/2 x 1-1/2" Hex Bolts	

BBMET METRIC – BUCKET OF BOLTS

25 qty	M6 x 16mm Set Screws	Metric, H/T, GR8.8, Hex Nuts, Flat Washers and Spring Washers to suit.	
25	M6 x 20mm Set Screws		
15	M6 x 25mm Set Screws		
15	M6 x 30mm Set Screws		
10	M6 x 40mm Set Screws		
10	M6 x 50mm Set Screws		
20	M8 x 20mm Set Screws		
20	M8 x 25mm Set Screws		
8	M8 x 45mm Set Screws		
8	M8 x 50mm Set Screws		
8	M10 x 25mm Set Screws		
10	M10 x 35mm Bolts		20 Sizes: M6 to M12 <i>Sizes may vary according to availability, but quantities remain the same. Individual sizes supplied in poly bags.</i>
8	M10 x 40mm Set Screws		
5	M10 x 50mm Set Screws		
5	M10 x 60mm Set Screws		
5	M12 x 45mm Set Screws		
5	M12 x 50mm Hex Bolts		
5	M12 x 50mm Set Screws		
5	M12 x 55mm Hex Bolts		
3	M12 x 75mm Set Screws		

111 PIECE TAP AND DIE SET – ALLOY STEEL

CTD110 TAP AND DIE SET

Thread Range: UNF, UNC, UNS, NPT, Metric ISO and Metric Fine

- 1 x Tap Wrench 1/8" to 1/2" (3mm to 12mm)
- 1 x Tap Wrench 1/4" to 3/4" (6mm to 20mm)
- 1 x 'T' Handle Tap Wrench
- 1 x Die Stock (1" OD) Handle Wrench
- 1 x Die Stock (1-1/2" OD) Handle Wrench

70 TAPS: 35 Intermediate & 35 Plug
35 DIES: 23 x 1" & 13 x 1-1/2"



INTERMEDIATE & PLUG TAPS *Size Range*

UNF	METRIC ISO
10/32" - 32 TPI	M6 x 1.00
1/4" - 28 TPI	M8 x 1.25
5/16" - 24 TPI	M10 x 1.5
3/8" - 24 TPI	M11 x 1.5
7/16" - 20 TPI	M12 x 1.75
1/2" - 20 TPI	
9/16" - 18 TPI	
5/8" - 18 TPI	
3/4" - 16 TPI	
UNC	METRIC FINE
4/40" - 40 TPI	M10 x 1.00
6/32" - 32 TPI	M10 x 1.25
8/32" - 32 TPI	M12 x 1.25
10/24" - 24 TPI	M14 x 1.25
12/24" - 24 TPI	M18 x 1.5
UNS	UNS
1/4" - 20 TPI	1/4" - 24 TPI
5/16" - 18 TPI	1/4" - 24 TPI
3/8" - 16 TPI	
7/16" - 14 TPI	
1/2" - 13 TPI	
9/16" - 12 TPI	
5/8" - 11 TPI	
3/4" - 10 TPI	
NPT	NPT
1/8" - 27 TPI	1/8" - 27 TPI
1/4" - 18 TPI	1/4" - 18 TPI

DIE NUTS *Size Range: 22 x 1" & 13 x 1-1/2"*

UNF	METRIC ISO
10/32" - 32 TPI	M6 x 1.00
1/4" - 28 TPI	M8 x 1.25
5/16" - 24 TPI	M10 x 1.5
3/8" - 24 TPI	M11 x 1.5
7/16" - 20 TPI	M12 x 1.75
1/2" - 20 TPI	
9/16" - 18 TPI	
5/8" - 18 TPI	
3/4" - 16 TPI	
UNC	METRIC FINE
4/40" - 40 TPI	M10 x 1.00
6/32" - 32 TPI	M10 x 1.25
8/32" - 32 TPI	M12 x 1.25
10/24" - 24 TPI	M14 x 1.25
12/24" - 24 TPI	M18 x 1.5
UNS	UNS
1/4" - 20 TPI	1/4" - 24 TPI
5/16" - 18 TPI	1/4" - 32 TPI
3/8" - 16 TPI	
7/16" - 14 TPI	
1/2" - 13 TPI	
9/16" - 12 TPI	
5/8" - 11 TPI	
3/4" - 10 TPI	
NPT	NPT
1/8" - 27 TPI	1/8" - 27 TPI
1/4" - 18 TPI	1/4" - 18 TPI

COTTER PINS

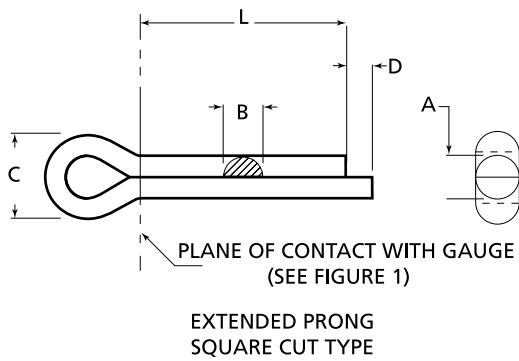

'O' RINGS

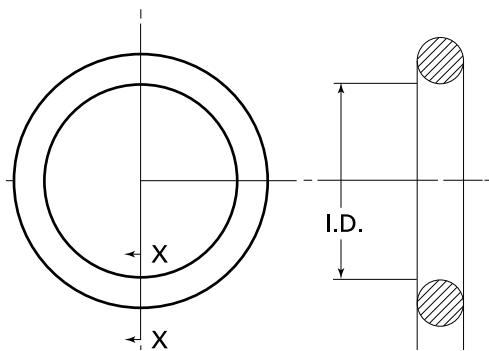

CLEVIS PINS

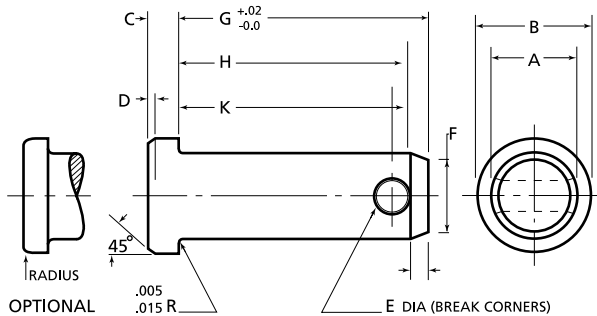

'R' CLIPS SIZE CHART

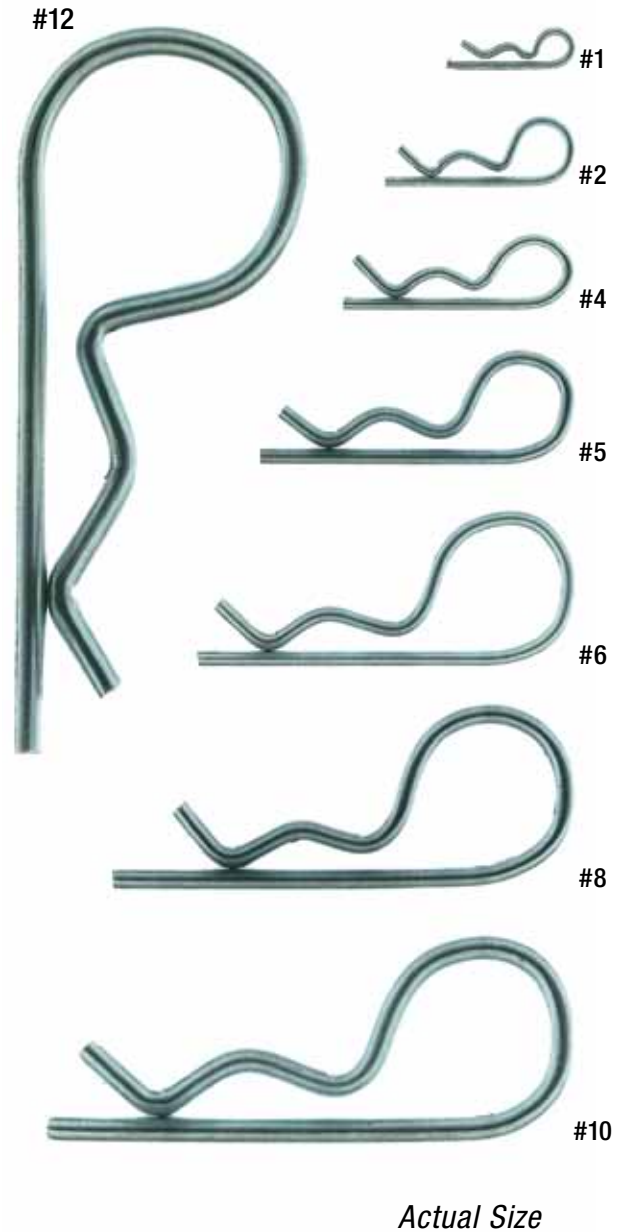

TAPER PINS

TAPER PIN NUMBER	0	1	2	3	4	5	6	7	8	9	10
DIAMETER LARGE END – INCH	.156	.172	.193	.219	.250	.289	.341	.409	.492	.591	.706
APPROX. FRACTION SIZE – INCH	5/32	1/4	3/16	7/32	.250	19/64	1 1/32	13/32	1/2	19/32	23/32
APPROX. mm SIZE	3.96	4.36	4.76	5.55	6.35	7.54	8.7	10.3	12.7	15.0	18.2



TAPER PINS ARE MEASURED: LARGE END x LENGTH
STANDARD TAPER IS 1/4" PER 12"

IMPERIAL TO METRIC

IMPERIAL		METRIC	IMPERIAL		METRIC
SIZE	DECIMALS	mm	SIZE	DECIMALS	mm
1/64	.015625	0.397	33/64	.515625	13.097
1/32	.03125	0.794	17/32	.53125	13.494
3/64	.046875	1.191	35/64	.546875	13.891
1/16	.0625	1.588	9/16	.5625	14.288
5/64	.078125	1.984	37/64	.578125	14.684
3/32	.09375	2.381	19/32	.59375	15.081
7/64	.109375	2.778	39/64	.609375	15.478
1/8	.1250	3.175	5/8	.6250	15.875
9/64	.140625	3.572	41/64	.640625	16.272
5/32	.15625	3.969	21/32	.65625	16.669
11/64	.171875	4.366	43/64	.671875	17.066
3/16	.1875	4.763	11/16	.6875	17.463
13/64	.203125	5.159	45/64	.703125	17.859
7/32	.21875	5.556	23/32	.71875	18.256
15/64	.234375	5.953	47/64	.734375	18.653
1/4	.2500	6.350	3/4	.7500	19.050
17/64	.265625	6.747	49/64	.765625	19.447
9/32	.28125	7.144	25/32	.78125	19.844
19/64	.296875	7.541	51/64	.796875	20.241
5/16	.3125	7.938	13/16	.8125	20.638
21/64	.328125	8.334	53/64	.828125	21.034
11/32	.34375	8.731	27/32	.84375	21.431
23/64	.359375	9.128	55/64	.859375	21.828
3/8	.3750	9.525	7/8	.8750	22.225
25/64	.390625	9.922	57/64	.890625	22.622
13/32	.40625	10.319	29/32	.90625	23.019
27/64	.421875	10.716	59/64	.921875	23.416
7/16	.4375	11.113	15/16	.9375	23.813
29/64	.453125	11.509	61/64	.953125	24.209
15/32	.46875	11.906	31/32	.96875	24.606
31/64	.484375	12.303	63/64	.984375	25.003
1/2	.5000	12.700	1	1.000	25.400

1mm = .03937"

.001" = .0254mm

METRIC TO IMPERIAL

mm	INCHES	mm	INCHES
.1	.0039	47	1.8504
.2	.0079	48	1.8898
.3	.0118	49	1.9291
.4	.0157	50	1.9685
.5	.0197	51	2.0079
.6	.0236	52	2.0472
.7	.0276	53	2.0866
.8	.0315	54	2.1260
.9	.0354	55	2.1654
1	.0394	56	2.2047
2	.0787	57	2.2441
3	.1181	58	2.2835
4	.1575	59	2.3228
5	.1969	60	2.3622
6	.2362	61	2.4016
7	.2756	62	2.4409
8	.3150	63	2.4803
9	.3543	64	2.5197
10	.3937	65	2.5591
11	.4331	66	2.5984
12	.4724	67	2.6378
13	.5118	68	2.6772
14	.5512	69	2.7165
15	.5906	70	2.7559
16	.6299	71	2.7953
17	.6693	72	2.8346
18	.7087	73	2.8740
19	.7480	74	2.9134
20	.7874	75	2.9528
21	.8268	76	2.9921
22	.8661	77	3.0315
23	.9055	78	3.0709
24	.9449	79	3.1102
25	.9843	80	3.1496
26	1.0236	81	3.1890
27	1.0630	82	3.2283
28	1.1024	83	3.2677
29	1.1417	84	3.3071
30	1.1811	85	3.3465
31	1.2205	86	3.3858
32	1.2598	87	3.4252
33	1.2992	88	3.4646
34	1.3386	89	3.5039
35	1.3780	90	3.5433
36	1.4173	91	3.5827
37	1.4567	92	3.6220
38	1.4961	93	3.6614
39	1.5354	94	3.7008
40	1.5748	95	3.7402
41	1.6142	96	3.7795
42	1.6535	97	3.8189
43	1.6929	98	3.8583
44	1.7323	99	3.8976
45	1.7717	100	3.9370
46	1.8110		



A large rectangular area with horizontal lines, intended for handwritten notes.

CHAMPION QUALITY

CHAMPION SERVICE

CHAMPION PARTS



CHAMPION PARTS PTY LTD

205 Arden Street, North Melbourne VIC 3051

Phone: +61 3 9325 9000

Phone: +61 3 9326 5600

Fax: +61 3 9329 2452

www.championparts.com.au

sales@championparts.com.au

Premium quality is 'our' beginning