

Section 3

ADAPTORS

TAIPAN

acting on impulse...

Can't find what you're looking for? Contact us -



1300 654 782



07 5428 1311

All part numbers displayed in **BOLD ITALICS** are new items that may not be in stock as yet, please contact us for further details.

ADAPTOR IDENTIFICATION KEY

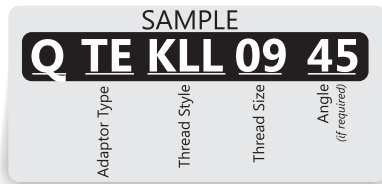

Notes: Each thread will have a code letter (refer following). If all of the threads are the same style, only one letter is required (E.G. QEBEE0604 can be shortened to QEBE0604). Thread should be in alphabetical order regardless of thread size (E.G. QAAB0402 not QABA0204) The thread size is in 1/16" increments ie 1 1/16 is 17, metric sizing is as per L (DIN light) or S(DIN Heavy) ie L10 or S10. As with the thread style letters, you may shorten where all of the threads are the same size. Do not shorten letters for tees where only two of the three threads are similar as this will cause confusion (E.G. QTEEEE020202 can be shortened to QTTEE02 but QTEKLL070909 should be shown as such).

Distributor indicator (1st letter) Q = Australian Hose & Fittings

Adaptor Type (2nd letter group)		Tube Fitting Type (2nd Letter Group)	
A	Straight Adaptor	TI	Tube Fittings Imperial
B	Bulkhead Fitting	TM	Tube Fittings Metric
C	Cap	For Compression / Flare Fittings (3rd Letter Group)	
CR	Cross	A	Straight Compression
EB	Elbow Block (short)	A1	Elbow M
EBB	bulkhead 90 deg	A2	Elbow M / F (s/w)
EL	Elbow Tube (long)	A3	Run Tee M / F / M (s/w)
ET	Elbow Tube	A4	Branch Tee M / M / F (s/w)
FB	Flange Blank	A5	Cross
LEB	Long Drop Block Elbow	A6	Cap Insert (used with A7)
NE	Extended Nipple	A7	Nut Metric
NI	Nipple	A8	Male Tube Blank
NU	Nut	A9K	Flare Nut
P	Plug	A10K - M	Flare Sleeve (K - JIC or M - Metric)
R	Reducer	A11	Cutting Ring
S	Socket	A12	Compression Tee
TE	Tee	A13	Flareless Sleeve
WF	Weld On - Female	A14	Flareless Nut
WM	Weld On - Male	A15	Bulkhead
Thread Style (3rd \ 4th letter group)		A16	Metric Female (s/w)
A	BSPP Female	Tube size always comes first and may be L (light DIN) or S (heavy DIN) as per original manufacturers part number.	
B	BSPT Female	Flange Block Key	
C	BSP Flat Face	BF1FA----O	Code 61 to Imperial Pipe
D	BSPP Male	BF1FB----UNC	Code 61 to Imperial Pipe
E	BSPT Male	BF2FA----O	Code 61 to Tube
F	Code 61	BF2FB----UNC	Code 61 to Tube
G	Code 62	BF1GA----O	Code 62 to Imperial Pipe
H	Imperial BSPP Female (Mitsubishi)	BF1GB----UNC	Code 62 to Imperial Pipe
J	Imperial BSPP Male (Mitsubishi)	BF2GA----O	Code 62 to Tube
K	JIC Female	BF2GB----UNC	Code 62 to Tube
L	JIC Male	BF3FA--O	Code 61 to BSPP Female
M	JIS Metric Female (Komatsu)	BF3FB--UNC	Code 61 to BSPP Female
N	JIS Metric Male (Komatsu)	BF3GA--O	Code 62 to BSPP Female
P	UN Oring Male (SAE Oring)	BF3GA--UNC	Code 62 to BSPP Female
PF	UN Oring Female (SAE Oring)	BF4AF----	Side Port Adaptor Code 61 X BSPP
Q	Metric Female	BF4AG	Side Port Adaptor Code 62 X BSPP
R	Metric Male	BF5AF	Adaptor Plate Code 61 X BSPP
S	Solid Female		
SF	SAE Female		
SM	SAE Male		
SP	Stand Pipe		
T	NPT Female		
U	NPT Male		
V	ORFS Female		
W	ORFS Male		
X	Low Pressure		

<h1 style="background-color: #0070C0; color: white; padding: 10px; text-align: center;">Straight Adaptors</h1>	QAABS Page 84	QAAD Page 84	QA AE Page 84	QAAP Page 85
				
	BSPT F x BSPP F S/W	BSPP F S/W x BSPP M	BSPP F S/W x BSPT M	BSPP F S/W x UNO M
QAAX Page 85	QA BSE Page 85	QA BSL Page 85 - 86	QA DF Page 86	QA DK Page 86
				
BSPP F S/W x L/P Hosetail	BSPT F x BSPT M	BSPT F x JIC M	BSPP M x Code 61	BSPP M x JIC F S/W
QA DKS Page 86	QA DX Page 87	QA EK Page 87	QA EPF Page 87	QA EV Page 87
				
BSPP M x JIC F	BSPP M x L/P Hosetail	BSPT M x JIC F S/W	BSPT M x UNO F	BSPT M x ORFS F S/W
QA EX Page 88	QA FL Page 88	QA FX Page 89	QA GL Page 89	QA GW Page 89
				
BSPT M x L/P Hosetail	Code 61 x JIC M	Code 61 x L/P Hosetail	Code 62 x JIC M	Code 62 x ORFS M
QA KL Page 89 - 90	QA KP Page 90	QA KU Page 90	QA KW Page 90	QA LTS Page 91
 Swivel  Solid				
JIC F x JIC M	JIC F S/W x UNO M	JIC F S/W x NPT M	JIC F S/W x ORFS M	JIC M x NPT F
QA LV Page 91	QA PX Page 91	QA ETS Page 91	QA TSU Page 92	QA TU Page 92
				
JIC M x ORFS F S/W	UNO M x L/P Hosetail	NPT F x BSPT M	NPT F x NPT M	NPT F S/W x NPT M
QA QSJ Page 92	QA UX Page 92	QA BD Page 93	QA BL Page 93	QA LTS Page 93
				
JIS (BSP) M x Metric M	NPT M x L/P Hosetail	BSPP M Bulkhead	JIC M Bulkhead	JIC M x NPT F Bulkhead

Can't find what you're looking for? Contact us -



1300 654 782



07 5428 1311























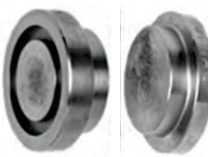

All part numbers displayed in **BOLD ITALICS** are new items that may not be in stock as yet, please contact us for further details.

<p>QBW Page 93</p>  <p>ORFS M Bulkhead</p>	<h2>45 Degree Elbows</h2>	<p>QEBAE Page 96</p>  <p>BSPP F S/W x BSPT M</p>	<p>QEBBS Page 97</p>  <p>BSPT F</p>	<p>QEBBSE Page 98</p>  <p>BSPT F x BSPT M (Cone)</p>
<p>QEBDE Page 98</p>  <p>BSPP M x BSPT M</p>	<p>QEBDL Page 99</p>  <p>BSPP M x JIC M</p>	<p>QEBE Page 100</p>  <p>BSPT M</p>	<p>QEBEL Page 101</p>  <p>BSPT M x JIC M</p>	<p>QEBEP Page 102</p>  <p>BSPT M x UNO M</p>
<p>QEBKL Page 103</p>  <p>JIC F S/W x JIC M</p>	<p>QEBKP Page 104</p>  <p>JIC F x UNO M</p>	<p>QEBLP Page 105</p>  <p>JIC M x UNO M</p>	<p>QEBLU Page 106</p>  <p>JIC M x NPT M</p>	<p>QEBPW Page 107</p>  <p>UNO M x ORFS M</p>
<p>QEBTS Page 108</p>  <p>NPT F</p>	<p>QEBTSU Page 109</p>  <p>NPT F x NPT M</p>	<p>QEBU Page 110</p>  <p>NPT M</p>	<p>QEBVW Page 110</p>  <p>ORFS F x ORFS M</p>	<p>QETFL Page 112</p>  <p>Code 61 x JIC M</p>
<p>QETFX Page 112</p>  <p>Code 61 x L/P Hosetail</p>	<p>QETGL Page 113</p>  <p>Code 62 x JIC M</p>	<p>QETGW Page 113</p>  <p>Code 62 x ORFS M</p>	<p>QETKL Page 114</p>  <p>JIC F x JIC M</p>	<h2>90 Degree Elbows</h2>
<p>QEBAE Page 96</p>  <p>BSPP F S/W x BSPT M</p>	<p>QEBAX Page 97</p>  <p>BSPP F S/W x L/P Hosetail</p>	<p>QEBLL Page 97</p>  <p>JIC M Bulkhead x JIC M</p>	<p>QEBBS Page 97</p>  <p>BSPT F</p>	<p>QEBBSE Page 98</p>  <p>BSPT F x BSPT M (Cone)</p>
<p>QEBDE Page 98</p>  <p>BSPP M x BSPT M</p>	<p>QEBDL Page 99 - 100</p>  <p>BSPP M x JIC M</p>	<p>QEBDW Page 100</p>  <p>BSPP M x ORFS M</p>	<p>QEBDX Page 100</p>  <p>BSPP M X L/P Hosetail</p>	<p>QEBE Page 101</p>  <p>BSPT M</p>

<p>QEBEK Page 101</p>  <p>BSPT M x JIC F S/W</p>	<p>QEDEL Page 102</p>  <p>BSPT M x JIC M</p>	<p>QEBEP Page 103</p>  <p>BSPT x UNO M</p>	<p>QEBEX Page 103</p>  <p>BSPT M x L/P Hosetail</p>	<p>QEBKL Page 104</p>  <p>JIC F S/W x JIC M</p>
<p>QEBKP Page 104</p>  <p>JIC F S/W x UNO M</p>	<p>QEBL Page 104 - 105</p>  <p>JIC M</p>	<p>QEBLP Page 105 - 106</p>  <p>JIC M x UNO M</p>	<p>QEBLR Page 106</p>  <p>JIC M x Metric M</p>	<p>QEBLU Page 107</p>  <p>JIC M x NPT M</p>
<p>QEBMN Page 107</p>  <p>JIS M x JIS F S/W (Metric Komatsu)</p>	<p>QEBPW Page 107 - 108</p>  <p>UNO M x ORFS M</p>	<p>QEBPX Page 108</p>  <p>UNO M x L/P Hosetail</p>	<p>QEBFSM Page 108</p>  <p>SAE F S/W x SAE M</p>	<p>QEBTS Page 109</p>  <p>NPT F</p>
<p>QEBTSU Page 109</p>  <p>NPT F x NPT M</p>	<p>QEBTU Page 109</p>  <p>NPT F S/W x NPT M</p>	<p>QEBU Page 110</p>  <p>NPT M</p>	<p>QEBVW Page 110</p>  <p>ORFS F S/W x ORFS M</p>	<p>QEBW Page 110</p>  <p>ORFS M</p>
<p>QELE Page 111</p>  <p>BSPT M</p>	<p>QELFL Page 111</p>  <p>Code 61 x JIC M</p>	<p>QELGL Page 111</p>  <p>Code 62 x JIC M</p>	<p>QELKL Page 111</p>  <p>JIC F S/W x JIC M</p>	<p>QETFL Page 112</p>  <p>Code 61 x JIC M</p>
<p>QETFX Page 113</p>  <p>Code 61 x L/P Hosetail</p>	<p>QETGL Page 113</p>  <p>Code 62 x JIC M</p>	<p>QETGW Page 114</p>  <p>Code 62 x ORFS M</p>	<p>QETKL Page 114</p>  <p>JIC F x JIX M</p>	<p>QLEBLP Page 119</p>  <p>JIC M x UNO M Extended</p>
<p>QLEBLU Page 119</p>  <p>JIC M x NPT M Extended</p>	<h1>Nipples</h1>		<p>QNELP Page 119</p>  <p>JIC M x UNO M Extended</p>	<p>QNID Page 120</p>  <p>BSPP M</p>
			<p>QNIDE Page 120</p>  <p>BSPP M x BSPT M</p>	

<p>QNIDL Page 121</p>  <p>BSPP M x JIC M</p>	<p>QNIDU Page 122</p>  <p>BSPP M x NPT M</p>	<p>QNIDW Page 122</p>  <p>BSPP M x ORFS M</p>	<p>QNIIE Page 122 - 123</p>  <p>BSPT M</p>	<p>QNIEL Page 123 - 124</p>  <p>BSPT M x JIC M</p>		
<p>QNIEN Page 124</p>  <p>BSPT M x JIS M (Metric Komatsu)</p>	<p>QNIIEP Page 124 - 125</p>  <p>BSPT M x UNO M</p>	<p>QNIIE R Page 125</p>  <p>BSPT M x Metric M</p>	<p>QNIIEU Page 125</p>  <p>BSPT M x NPT M</p>	<p>QNIL Page 125 - 126</p>  <p>JIC M</p>		
<p>QNILP Page 126 - 127</p>  <p>JIC M x UNO M</p>	<p>QNILR Page 127</p>  <p>JIC M x Metric M</p>	<p>QNILU Page 128</p>  <p>JIC M x NPT M</p>	<p>QNILW Page 128</p>  <p>JIC M x ORFS</p>	<p>QNIIPW Page 129</p>  <p>UNO M x ORFS M</p>		
<p>QNIIRW Page 129</p>  <p>Metric M x ORFS M</p>	<p>QNIISM Page 129</p>  <p>SAE M</p>	<p>QNIISM Page 130</p>  <p>SAE M x BSPT M</p>	<p>QNIISMU Page 130</p>  <p>SAE M x NPT M</p>	<p>QNIU Page 130</p>  <p>NPT M</p>		
<p>QNIW Page 131</p>  <p>ORFS M</p>	<h2>Nuts</h2>		<p>QNUA Page 131</p>  <p>BSPP F S/W Nut</p>	<p>QNUK Page 131</p>  <p>JIC F S/W Nut</p>	<h2>Tee's & Crosses</h2>	
<p>QTEAEE Page 139</p>  <p>BSPP F S/W x BSPT M x BSPT M</p>	<p>QTEAS Page 139</p>  <p>BSPP F</p>	<p>QTEASDD Page 139</p>  <p>BSPP F x BSPP M x BSPP M</p>	<p>QTEBBSE Page 140</p>  <p>BSPT M x BSPT F x BSPT F</p>	<p>QTEBLLL Page 140</p>  <p>JIC M Bulkhead x JIC M x JIC M</p>		
<p>QTEBS Page 140</p>  <p>BSPT F</p>	<p>QTEDEE Page 140</p>  <p>BSPP M x BSPT M x BSPT M</p>	<p>QTEDLL Page 141</p>  <p>BSPP M x JIC M x JIC M</p>	<p>QTEE Page 141</p>  <p>BSPT M</p>	<p>QTEELL Page 141</p>  <p>BSPT M x JIC M x JIC M</p>		

QTEKLL Page 141 - 142  JIC F S/W x JIC M x JIC M	QTEL Page 142  JIC M	QTELLD Page 142  JIC M x JIC M x BSPP M	QTELE Page 142  JIC M x JIC M x BSPT M	QTELLK Page 143  JIC M x JIC M x JIC F
QTELLLB Page 143  JIC M x JIC M Bulkhead x JIC M	QTELLP Page 143  JIC M x JIC M x UNO M	QTELLU Page 143  JIC M x JIC M x NPT M	QTEPL Page 144  JIC M x UNO M x JIC M	QTEMNN Page 144  JIS S/W (Komatsu) x JIS M x JIS M
QTETS Page 144  NPT Taper F	QTETTSU Page 144  NPT F x NPT F x NPT M	QTEUT Page 145  NPT M x NPT F x NPT F	QTEU Page 145  NPT M	QTEULL Page 145  NPT M x JIC M x JIC M
QTEUUTS Page 145  NPT M x NPT M x NPT F	QTEVWW Page 146  ORFS F x ORFS M x ORFS M	QTEW Page 146  ORFS M	QTEWWV Page 146  ORFS M x ORFS M x ORFS F	QTEXXA Page 146  L/P Hosetail x L/P Hosetail x BSPP F
QCRBS Page 96  BSPT F	QCRL Page 96  JIC M	Test Port Adaptors		QTEADPFS Page 147  BSPP F x BSPP M x UNO F
QTEVWPFS Page 147  ORFS F x ORFS M x UNO F	Plugs & Caps		QCA Page 94  BSPP F S/W	QCH Page 94  BSPP F (Imperial Mitsubishi)
QCK Page 94  JIC F S/W	QCKS Page 94 - 95  JIC F Solid	QCM Page 95  JIS F (Metric Komatsu)	QCV Page 95  ORFS F	QPD Page 132  BSPP M
QPD-A Page 132  BSPP M (Allen Head)				

<p>QPE Page 132</p>  <p>BSPT M</p>	<p>QPE-CS Page 132</p>  <p>BSPT M (Counter Sunk)</p>	<p>QPJ Page 133</p>  <p>JIS (BSP Imperial Mitsubishi)</p>	<p>QPL Page 133</p>  <p>JIC M</p>	<p>QPN Page 133</p>  <p>JIS M (Metric Komatsu)</p>	
<p>QPP Page 133</p>  <p>UNO M</p>	<p>QPP-A Page 134</p>  <p>UNO M (Allen Head)</p>	<p>QPR Page 134</p>  <p>Metric M Port Plug</p>	<p>QPU Page 134</p>  <p>NPT M</p>	<p>QPU-CS Page 135</p>  <p>NPT M (Counter Sunk)</p>	
<p>QPW Page 135</p>  <p>ORFS M</p>	<p>Reducing Bushes</p>		<p>QRASD Page 135</p>  <p>BSPP F x BSPP M</p>	<p>QRBE Page 136</p>  <p>BSPT F x BSPT M</p>	
<p>QRKL Page 136</p>  <p>JIC F x JIC M</p>	<p>QRTU Page 137</p>  <p>NPT M x NPT F</p>	<p>QRVW Page 137</p>  <p>ORFS F x ORFS M</p>	<p>Sockets</p>		
<p>QSA Page 138</p>  <p>BSPP F</p>	<p>QSB Page 138</p>  <p>BSPT F</p>	<p>QSPF Page 138</p>  <p>UNO F</p>	<p>QST Page 139</p>  <p>NPT F</p>	<p>Flanges & Flange Clamps</p>	
<p>QFBF Page 115</p>  <p>Code 61 Blanking Plug</p>	<p>QFBF-B-UNC Page 115</p>  <p>Code 61 Flange Blanking Plate</p>	<p>QFCF Page 116</p>  <p>Code 61 Flange Clamps</p>	<p>QFCF-UNC Page 116</p>  <p>Code 61 Flange Clamps (Inc Bolts)</p>	<p>QFCF-METRIC Page 116</p>  <p>Code 61 Flange Clamps (Inc Bolts)</p>	
<p>QFCF-BOLT-UNC Page 116</p>  <p>Code 61 Bolt Set Imperial</p>	<p>QFCF-BOLT-METRIC Page 117</p>  <p>Code 61 Bolt Set Metric</p>	<p>QFBG Page 115</p>  <p>Code 62 Blanking Plug</p>	<p>QFBG-B-UNC Page 115</p>  <p>Code 62 Flange Blanking Plate</p>	<p>QFCG Page 117</p>  <p>Code 62 Flange Clamps</p>	
<p>QFCG-UNC Page 117</p>  <p>Code 62 Flange Clamps (Inc Bolts)</p>	<p>QFCG-METRIC Page 117</p>  <p>Code 62 Flange Clamps (Inc Bolts)</p>				

QFCG-BOLT-UNC Page 118  Code 62 Bolt Set Imperial	QFCG-BOLT-METRIC Page 118  Code 62 Bolt Set Metric	QFCG-CAT-UNC Page 118  CAT Flange Clamps PICTURE NOT AVAILABLE	BF1FA-O Page 163  Code 61 - Imperial Pipe	BF1FB-UNC Page 163  Code 61 UNC - Imperial Pipe
BF2FA-O Page 163  Code 61 - Imperial Tube	BF2FB-UNC Page 163  Code 61 UNC - Imperial Tube	BF3FA-O Page 164  Code 61 Block x BSPP F	BF3FB-UNC Page 164  Code 61 Block x BSPP X UNC Tapered Holes	BF3GA-O Page 164  Code 62 Block x BSPP F
BF3GB-UNC Page 164  Code 62 Block x BSPP X UNC Tapered Holes	BF4AF Page 165  Code 61 x BSPP F Side Port	Tube Fittings		QTIA9K Page 148  JIC Tube Nut
QTMA Page 148 - 149  Metric Tube Joiner	QTMA1 Page 149  Metric Tube Elbow	QTMA2 Page 149 - 150  Metric F S/W x Metric Tube	QTMA3 Page 150  Metric Tube Run Tee	QTMA4 Page 150 - 151  Metric Tube Branch Tee
QTMA6 Page 151  Metric Tube Blanking Plug	QTMA7 Page 151 - 152  Metric Tube Nut	QTMA8 Page 152  Metric Tube Blanking Plug	QTMA10K Page 152  For use with QTIA9K Nuts JIC Tube Sleeve	QTMA11 Page 153  Metric Cutting Ring
QTMA12 Page 153  Metric Tubes Tee Piece	QTMA15 Page 154  Metric Bulkhead	QTMA1E Page 154  Metric Tube x BSPT M Elbow	QTMA1D Page 155  Metric Tube x BSPP M Elbow	QTMA1P Page 155  Metric Tube x UNO Elbow
QTMA D Page 156  Metric Tube x BSPP M	QTMAE Page 157  Metric Tube x BSPT M	QTMA L Page 157  Metric Tube x JIC M	QTMA P Page 158  Metric Tube x UNO M	Weld On Adaptors

QWFA Page 159 	QWFK Page 159 	QWFPF Page 159 	QWME Page 160 	QWMF Page 160 
BSPP Tubeweld	JIC F S/W	UNO F	BSPT M	Code 61
QWVG Page 160 	QWML Page 160 	Stainless Steel	SSBN Page 165 	SSE Page 165 
Code 62	JIC M		BSPP M Pipe	BSPP F Elbow
SSEMF 45° Page 165 	SSEMF 90° Page 166 	SSHN Page 166 	SSHP Page 166 	SSMS Page 166 
BSPP M x BSPP F Elbow	BSPP M x BSPP F Elbow	BSPP Nipple	BSPT Plug	BSPP Socket
SSRB Page 166 	SST Page 167 	Low Pressure Bends	45° Page 161 	90° Page 161 
BSPP Reducing Bush	BSPP F Tee		Low Pressure Bend	Low Pressure Bend
High Pressure Bends	45° 6SWG Page 161 	45° 8SWG Page 162 	90° 6SWG Page 162 	90° 8SWG Page 162 
	High Pressure Bend	High Pressure Bend	High Pressure Bend	High Pressure Bend
Stand Pipe	90° SP Page 162 	MORE PRODUCTS COMING SOON	MORE PRODUCTS COMING SOON	MORE PRODUCTS COMING SOON
	Stand Pipe			
MORE PRODUCTS COMING SOON	MORE PRODUCTS COMING SOON	MORE PRODUCTS COMING SOON	MORE PRODUCTS COMING SOON	MORE PRODUCTS COMING SOON

ADAPTORS (QA) Straight

BSPT Female Solid x BSPP Female Nut Swivel



Part Number	BSPT F	BSPP F S/W	
QAABS04	1/4	1/4	
QAABS06	3/8	3/8	
QAABS08	1/2	1/2	
QAABS12	3/4	3/4	
QAABS16	1	1	

BSPP Female Swivel Nut x BSPP Male



Part Number	BSPP F S/W	BSPP M	
QAAD04	1/4	1/4	
QAAD06	3/8	3/8	
QAAD08	1/2	1/2	
QAAD12	3/4	3/4	
QAAD16	1	1	
QAAD1608	1	1/2	
QAAD20	1 1/4	1 1/4	
QAAD2008	1 1/4	1/2	

BSPP Female Swivel Nut x BSPT Male

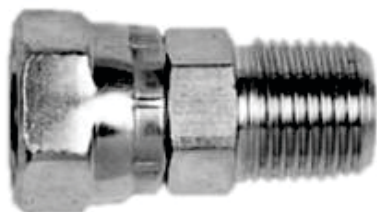

Part Number	BSPP F S/W	BSPT M	
QAAE02	1/8	1/8	
QAAE04	1/4	1/4	
QAAE0406	1/4	3/8	
QAAE06	3/8	3/8	
QAAE0604	3/8	1/4	
QAAE0608	3/8	1/2	
QAAE08	1/2	1/2	
QAAE0806	1/2	3/8	
QAAE0812	1/2	3/4	
QAAE12	3/4	3/4	
QAAE1208	3/4	1/2	
QAAE16	1	1	
QAAE1612	1	3/4	
QAAE20	1 1/4	1 1/4	
QAAE24	1 1/2	1 1/2	
QAAE2420	1 1/2	1 1/4	
QAAE32	2	2	

BSPP Female Swivel Nut x UNO Male

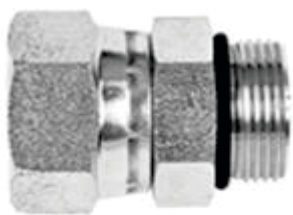

Part Number	BSPP F S/W	UNO M	
QAAP0812	1/2	3/4	
QAAP0814	1/2	7/8	
QAAP1214	3/4	7/8	
QAAP1217	3/4	1 1/16	
QAAP1621	1	1 5/16	

BSPP Female Swivel Nut x Low Pressure Hosetail



Part Number	BSPP F S/W	L/P Hosetail	
QAAX16	1	1	

BSPT Female Solid x BSPT Male

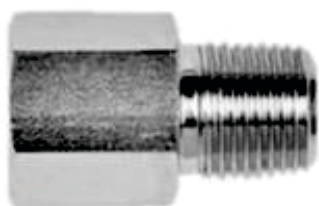

Part Number	BSPT F	BSPT M	
QABSE02	1/8	1/8	
QABSE04	1/4	1/4	
QABSE0402	1/4	1/8	
QABSE06	3/8	3/8	
QABSE0604	3/8	1/4	
QABSE08	1/2	1/2	
QABSE0806	1/2	3/8	
QABSE12	3/4	3/4	
QABSE1208	3/4	1/2	
QABSE16	1	1	
QABSE1612	1	3/4	

BSPT Female Solid x JIC Male



Part Number	BSPT F	JIC M	
QABSL0207	1/8	7/16	
QABSL0407	1/4	7/16	
QABSL0409	1/4	9/16	
QABSL0412	1/4	3/4	
QABSL0414	1/4	7/8	
QABSL0417	1/4	1 1/16	
QABSL0609	3/8	9/16	
QABSL0612	3/8	3/4	
QABSL0809	1/2	9/16	
QABSL0812	1/2	3/4	
QABSL0814	1/2	7/8	

Continued on following page

BSPT Female Solid x JIC Male Continued...



Part Number	BSPT F	JIC M	
QABSL0817	1/2	1 1/16	
QABSL1209	3/4	9/16	
QABSL1217	3/4	1 1/16	
QABSL1621	1	1 5/16	

BSPP Male x Code 61 Flange



Part Number	BSPP M	C61 Flange	
QADF16	1	1	

BSPP Male x JIC Female Swivel Nut



Part Number	BSPP M	JIC F S/W	
QADK0407	1/4	7/16	
QADK0409	1/4	9/16	
QADK0609	3/8	9/16	
QADK0612	3/8	3/4	
QADK0614	3/8	7/8	
QADK0812	1/2	3/4	
QADK0814	1/2	7/8	
QADK1214	3/4	7/8	
QADK1217	3/4	1 1/16	
QADK1617	1	1 1/16	
QADK1621	1	1 5/16	
QADK2021	1 1/4	1 5/16	
QADK2026	1 1/4	1 5/8	
QADK2030	1 1/4	1 7/8	
QADK2430	1 1/2	1 7/8	

BSPP Male x JIC Female Solid



Part Number	BSPP M	JIC F Solid	
QADKS0814	1/2	7/8	

BSP Parallel Male x Low Pressure Hosetail

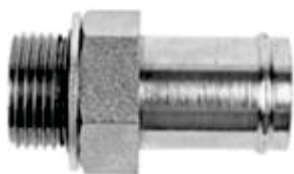

Part Number	BSPP M	L/P Hosetail	
QADX12	3/4	3/4	
QADX16	1	1	
QADX1620	1	1 1/4	
QADX20	1 1/4	1 1/4	
QADX2024	1 1/4	1 1/2	

BSPT Male x JIC Female Swivel Nut



Part Number	BSPT M	JIC F	
QAEK0207	1/8	7/16	
QAEK0209	1/8	9/16	
QAEK0407	1/4	7/16	
QAEK0409	1/4	9/16	
QAEK0609	3/8	9/16	
QAEK0612	3/8	3/4	
QAEK0614	3/8	7/8	
QAEK0812	1/2	3/4	
QAEK0814	1/2	7/8	
QAEK0817	1/2	1 1/16	
QAEK1214	3/4	7/8	
QAEK1217	3/4	1 1/16	
QAEK1221	3/4	1 5/16	
QAEK1621	1	1 5/16	
QAEK2026	1 1/4	1 5/8	

BSPT Male x UNO Female Solid



Part Number	BSPT M	UNO F	
QAEPF0612	3/8	3/4	
QAEPF0812	1/2	3/4	
QAEPF0814	1/2	7/8	
QAEPF1217	3/4	1 1/16	
QAEPF1612	1	3/4	
QAEPF1617	1	1 1/16	
QAEPF1621	1	1 5/16	

BSPT Male x ORFS Female Swivel Nut



Part Number	BSPT M	ORFS F	
QAEV0209	1/8	9/16	
QAEV0409	1/4	9/16	
QAEV0411	1/4	11/16	
QAEV0611	3/8	11/16	
QAEV0613	3/8	13/16	
QAEV0813	1/2	13/16	

BSPT Male x L/P Hosetail



Part Number	BSPT M	L/P Hosetail	
QAEX08	1/2	1/2	
QAEX0812	1/2	3/4	
QAEX12	3/4	3/4	
QAEX1216	3/4	1	
QAEX1220	3/4	1 1/4	
QAEX16	1	1	
QAEX1612	1	3/4	
QAEX1614	1	7/8	
QAEX1618	1	1 1/8	
QAEX1620	1	1 1/4	
QAEX1624	1	1 1/2	
QAEX20	1 1/4	1 1/4	
QAEX2014	1 1/4	7/8	
QAEX2016	1 1/4	1	
QAEX2018	1 1/4	1 1/8	
QAEX2022	1 1/4	1 3/8	
QAEX2024	1 1/4	1 1/2	
QAEX2418	1 1/2	1 1/8	
QAEX2422	1 1/2	1 3/8	
QAEX24	1 1/2	1 1/2	
QAEX2420	1 1/2	1 1/4	
QAEX3224	2	1 1/2	
QAEX3229	2	1 13/16	
QAEX32	2	2	

Code 61 Flange x JIC Male - 5000 psi

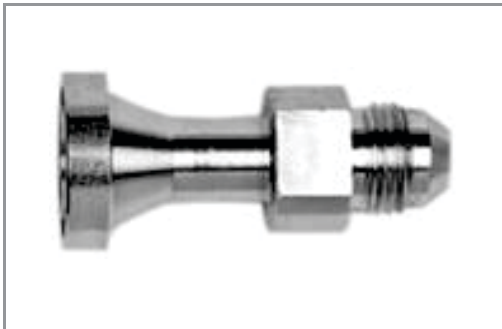

Part Number	C61 Flange	JIC M	
QAFL0812	1/2	3/4	
QAFL12	3/4	3/4	
QAFL1214	3/4	7/8	
QAFL1217	3/4	1 1/16	
QAFL1617	1	1 1/16	
QAFL1621	1	1 5/16	
QAFL2017	1 1/4	1 1/16	
QAFL2021	1 1/4	1 5/16	
QAFL2026	1 1/4	1 5/8	
QAFL2030	1 1/4	1 7/8	
QAFL2421	1 1/2	1 5/16	
QAFL2426	1 1/2	1 5/8	
QAFL2430	1 1/2	1 7/8	
QAFL3230	2	1 7/8	
QAFL3240	2	2 1/2	

Code 61 Flange x Low Pressure Hosetail



Part Number	C61 Flange	L/P Hosetail	
QAFX24	1 1/2	1 1/2	
QAFX32	2	2	
QAFX4032	2 1/2	2	

Code 62 Flange x JIC Male - 6000 psi



Part Number	C62 Flange	JIC M	
QAGL0812	1/2	3/4	
QAGL1217	3/4	1 1/16	
QAGL1617	1	1 1/16	
QAGL1621	1	1 5/16	
QAGL1626	1	1 5/8	
QAGL2021	1 1/4	1 5/16	
QAGL2026	1 1/4	1 5/8	
QAGL2421	1 1/2	1 5/16	
QAGL2426	1 1/2	1 5/8	
QAGL2430	1 1/2	1 7/8	
QAGL3240	2	2 1/2	

Code 62 Flange x ORFS Male - 6000 psi



Part Number	C62 Flange	ORFS M	
QAGW1219	3/4	1 3/16	
QAGW1223	3/4	1 7/16	
QAGW1623	1	1 7/16	
QAGW2027	1 1/4	1 11/16	

JIC Female x JIC Male

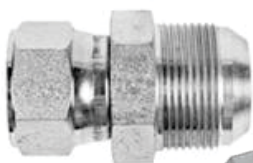

Swivel



Solid

Part Number	JIC F	JIC M	
QAKL0607	3/8	7/16	Solid
QAKL07	7/16	7/16	Swivel
QAKL0709	7/16	9/16	Solid
QAKL09	9/16	9/16	Swivel
QAKL0912	9/16	3/4	Solid
QAKL12	3/4	3/4	Swivel
QAKL1214	3/4	7/8	Solid
QAKL1217	3/4	1 1/16	Solid
QAKL14	7/8	7/8	Swivel
QAKL1417	7/8	1 1/16	Solid
QAKL17	1 1/16	1 1/16	Swivel

Continued on the following page

JIC Female x JIC Male Continued...

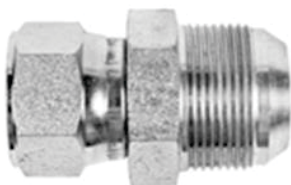

Part Number	JIC F	JIC M	
QAKL1721	1 1/16	1 5/16	Solid
QAKL21	1 5/16	1 5/16	Swivel
QAKL2126	1 5/16	1 5/8	Solid
QAKL2630	1 5/8	1 7/8	Solid

JIC Female Swivel Nut x UNO



Part Number	JIC F	UNO	
QAKP07	7/16	7/16	
QAKP09	9/16	9/16	
QAKP0912	9/16	3/4	
QAKP12	3/4	3/4	
QAKP1209	3/4	9/16	
QAKP14	7/8	7/8	
QAKP1412	7/8	3/4	
QAKP1417	7/8	1 1/16	
QAKP17	1 1/16	1 1/16	
QAKP21	1 5/16	1 5/16	
QAKP26	1 5/8	1 5/8	

JIC Female Swivel x NPT Male



Part Number	JIC F	NPT M	
QAKU0704	7/16	1/4	
QAKU0812	1/2	3/4	
QAKU0904	9/16	1/4	
QAKU1208	3/4	1/2	
QAKU1712	1 1/16	3/4	
QAKU2116	1 5/16	1	

JIC Female S/W x ORFS Male

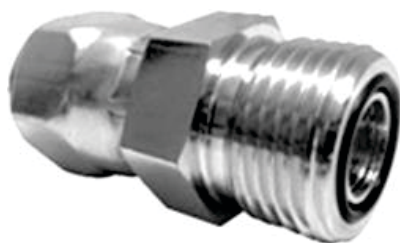

Part Number	JIC F S/W	ORFS M	
QAKW0709	7/16	9/16	
QAKW0911	9/16	11/16	
QAKW1213	3/4	13/16	
QAKW1416	7/8	1	
QAKW1719	1 1/16	1 3/16	
QAKW2123	1 5/16	1 7/16	

JIC Male x NPT Female Solid

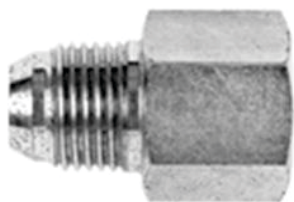

Part Number	JIC M	NPT F Solid	
QALTS0702	7/16	1/8	
QALTS0704	7/16	1/4	
QALTS0906	9/16	3/8	
QALTS1208	3/4	1/2	
QALTS1716	1 1/16	1	
QALTS2116	1 5/16	1	

JIC Male x ORFS Female Swivel Nut



Part Number	JIC M	ORFS F S/W	
QALV0709	7/16	9/16	
QALV0911	9/16	11/16	
QALV1213	3/4	13/16	
QALV1416	7/8	1	
QALV1719	1 1/16	1 3/16	
QALV2123	1 5/16	1 7/16	

UNO Male x Low Pressure Hose Tail

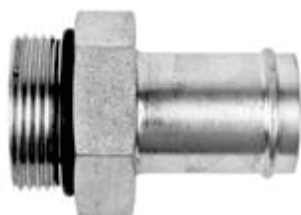

Part Number	UNO M	L/P Hosetail	
QAPX1716	1 1/16	1	
QAPX2116	1 5/16	1	
QAPX2120	1 5/16	1 1/4	
QAPX2124	1 5/16	1 1/2	
QAPX2620	1 5/8	1 1/4	
QAPX2624	1 5/8	1 1/2	
QAPX3024	1 7/8	1 1/2	

NPT Female Solid x BSPT Male

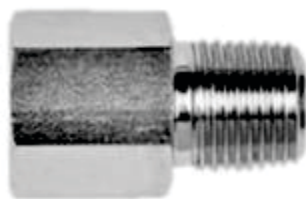

Part Number	NPT F	BSPT M	
QATSE16	1	1	

NPT Female Solid x NPT Male

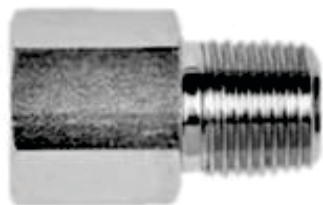

Part Number	NPT F	NPT M	
QATSU02	1/8	1/8	
QATSU0604	3/8	1/4	

NPT Female Swivel x NPT Male



Part Number	NPT F S/W	NPT M	
QATU02	1/8	1/8	
QATU04	1/4	1/4	
QATU06	3/8	3/8	

JIS (BSP) Male x Metric Female Solid

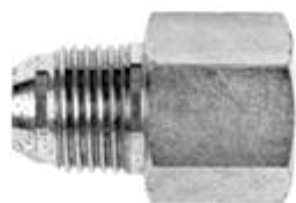

Part Number	JIS (BSP) M	Metric F	
QAJQS0822	1/2	22 x 1.5	

NPT Male x Low Pressure Hose Tail



Part Number	NPT M	L/P Hosetail	
QAUX20	1 1/4	1 1/4	
QAUX24	1 1/2	1 1/2	
QAUX32	2	2	
QAUX3224	2	1 1/2	
QAUX3236	2	2 1/4	

ADAPTORS (QB) Bulkhead

BSP Parallel Male Bulkhead



Part Number	BSPP M	BSPP M B/H	
QBD04	1/4	1/4	
QBD06	3/8	3/8	
QBD08	1/2	1/2	
QBD12	3/4	3/4	
QBD16	1	1	
QBD20	1 1/4	1 1/4	
QBD24	1 1/2	1 1/2	
QBD32	2	2	

JIC Male Bulkhead



Part Number	JIC M	JIC M	
QBL07	7/16	7/16	
QBL09	9/16	9/16	
QBL12	3/4	3/4	
QBL14	7/8	7/8	
QBL17	1 1/16	1 1/16	
QBL21	1 5/16	1 5/16	
QBL26	1 5/8	1 5/8	
QBL30	1 7/8	1 7/8	
QBL40	2 1/2	2 1/2	

JIC Male Bulkhead x NPT Female Solid



Part Number	JIC M B/H	NPT F Solid	
QBLTS0702	7/16	1/8	
QBLTS0704	7/16	1/4	

ORFS Male Bulkhead



Part Number	ORFS M	ORFS M B/H	
QBW09	9/16	9/16	
QBW11	11/16	11/16	
QBW13	13/16	13/16	
QBW16	1	1	
QBW19	1 3/16	1 3/16	
QBW23	1 7/16	1 7/16	
QBW27	1 11/16	1 11/16	

ADAPTORS (QC) Caps

BSPF Female Swivel Nut



Part Number	BSPF F		
QCA02	1/8		
QCA04	1/4		
QCA06	3/8		
QCA08	1/2		
QCA10	5/8		
QCA12	3/4		
QCA16	1		
QCA20	1 1/4		
QCA24	1 1/2		
QCA32	2		

Imperial BSPF Female (Mitsubishi)



Part Number	JIS F (BSP)		
QCH04	1/4		
QCH06	3/8		
QCH08	1/2		

JIC Female Swivel Nut



Part Number	JIC F		
QCK07	7/16		
QCK08	1/2		
QCK09	9/16		
QCK12	3/4		
QCK14	7/8		
QCK17	1 1/16		
QCK19	1 3/16		
QCK21	1 5/16		
QCK26	1 5/8		
QCK30	1 7/8		
QCK40	2 1/2		

JIC Female Solid

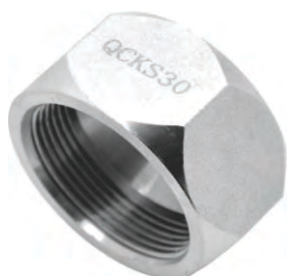

Part Number	JIC F		
QCKS07	7/16		
QCKS09	9/16		
QCKS12	3/4		
QCKS14	7/8		
QCKS17	1 1/16		
QCKS21	1 5/16		

Continued on the following page

Can't find what you're looking for? Contact us -



1300 654 782



07 5428 1311

All part numbers displayed in **BOLD ITALICS** are new items that may not be in stock as yet, please contact us for further details.

JIC Female Solid Continued...

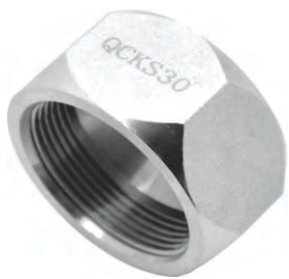

Part Number	JIC F		
QCKS26	1 5/8		
QCKS30	1 7/8		
QCKS40	2 1/2		

JIS Metric (Komatsu) Female



Part Number	JIS (KF)		
QCM14	14mm		
QCM16	16mm		
QCM18	18mm		
QCM20	20mm		
QCM22	22mm		
QCM24	24mm		
QCM26	26mm		
QCM30	30mm		
QCM33	33mm		

ORFS Female



Part Number	ORFS F		
QCV09	9/16		
QCV11	11/16		
QCV13	13/16		
QCV16	1		
QCV19	1 3/16		
QCV23	1 7/16		
QCV27	1 11/16		
QCV32	2		

ADAPTORS (QCR) Cross

BSPT Female Solid



Part Number	BSPT F		
QCRBS04	1/4		
QCRBS06	3/8		
QCRBS08	1/2		
QCRBS12	3/4		
QCRBS16	1		

JIC Male Solid



Part Number	JIC M		
QCRL12	3/4		

ADAPTORS (QEB) Elbow

BSPF Female S/W x BSPT Male - 45°



Part Number	BSPF F	BSPT M	
QEBAE0245	1/8	1/8	
QEBAE0445	1/4	1/4	
QEBAE0645	3/8	3/8	
QEBAE0845	1/2	1/2	
QEBAE1245	3/4	3/4	
QEBAE1645	1	1	
QEBAE2045	1 1/4	1 1/4	
QEBAE2445	1 1/2	1 1/2	

BSPF Female S/W x BSPT Male - 90°



Part Number	BSPF F	BSPT M	
QEBAE02	1/8	1/8	
QEBAE04	1/4	1/4	
QEBAE06	3/8	3/8	
QEBAE0604	3/8	1/4	
QEBAE0608	3/8	1/2	
QEBAE08	1/2	1/2	
QEBAE12	3/4	3/4	
QEBAE16	1	1	
QEBAE20	1 1/4	1 1/4	
QEBAE24	1 1/2	1 1/2	
QEBAE32	2	2	

Can't find what you're looking for? Contact us -



1300 654 782



07 5428 1311

All part numbers displayed in **BOLD ITALICS** are new items that may not be in stock as yet, please contact us for further details.

BSPP Female Swivel x Low Pressure Hose Tail - 90°



Part Number	BSPP F	L/P Hosetail	
QEBAX16	1	1	

JIC Male Bulkhead x JIC Male - 90°



Part Number	JIC M B/H	JIC M	
QEBBLL07	7/16	7/16	
QEBBLL09	9/16	9/16	
QEBBLL12	3/4	3/4	
QEBBLL14	7/8	7/8	
QEBBLL17	1 1/16	1 1/16	
QEBBLL21	1 5/16	1 5/16	
QEBBLL26	1 5/8	1 5/8	

BSPT Solid Female - 45°



Part Number	BSPT F	BSPT F	
QEBBS0245	1/8	1/8	
QEBBS0445	1/4	1/4	
QEBBS0645	3/8	3/8	
QEBBS0845	1/2	1/2	
QEBBS1245	3/4	3/4	
QEBBS1645	1	1	

BSPT Solid Female - 90°



Part Number	BSPT F	BSPT F	
QEBBS02	1/8	1/8	
QEBBS04	1/4	1/4	
QEBBS06	3/8	3/8	
QEBBS08	1/2	1/2	
QEBBS12	3/4	3/4	
QEBBS16	1	1	
QEBBS20	1 1/4	1 1/4	
QEBBS24	1 1/2	1 1/2	
QEBBS32	2	2	

BSPT Female Solid x BSPT Male (cone) - 45°



Part Number	BSPT F	BSPT M	
QEBBSE0445	1/4	1/4	
QEBBSE0645	3/8	3/8	
QEBBSE0845	1/2	1/2	
QEBBSE1245	3/4	3/4	

BSPT Female Solid x BSPT Male (cone) - 90°

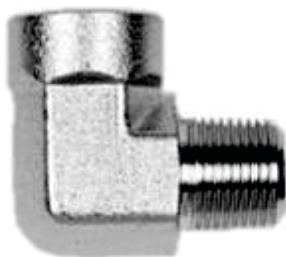

Part Number	BSPT F	BSPT M	
QEBBSE02	1/8	1/8	
QEBBSE04	1/4	1/4	
QEBBSE06	3/8	3/8	
QEBBSE0608	3/8	1/2	
QEBBSE08	1/2	1/2	
QEBBSE0806	1/2	3/8	
QEBBSE12	3/4	3/4	
QEBBSE1208	3/4	1/2	
QEBBSE16	1	1	
QEBBSE20	1 1/4	1 1/4	
QEBBSE24	1 1/2	1 1/2	
QEBBSE32	2	2	

BSPP Male x BSPT Male - 45°



Part Number	BSPP M	BSPT M	
QEBDE0445	1/4	1/4	
QEBDE0645	3/8	3/8	
QEBDE0845	1/2	1/2	
QEBDE1245	3/4	3/4	

BSPP Male x BSPT Male - 90°



Part Number	BSPP M	BSPT M	
QEBDE04	1/4	1/4	
QEBDE06	3/8	3/8	
QEBDE0604	3/8	1/4	
QEBDE08	1/2	1/2	
QEBDE12	3/4	3/4	
QEBDE16	1	1	
QEBDE1612	1	3/4	
QEBDE20	1 1/4	1 1/4	
QEBDE24	1 1/2	1 1/2	

BSPP Male x JIC Male - 45°



Part Number	BSPP M	JIC M	
QEBDL020745	1/8	7/16	
QEBDL040945	1/4	9/16	
QEBDL041245	1/4	3/4	
QEBDL060945	3/8	9/16	
QEBDL061245	3/8	3/4	
QEBDL080945	1/2	9/16	
QEBDL081245	1/2	3/4	
QEBDL081445	1/2	7/8	
QEBDL121445	3/4	7/8	
QEBDL121745	3/4	1 1/16	
QEBDL122145	3/4	1 5/16	
QEBDL1245	3/4	3/4	
QEBDL161745	1	1 1/16	
QEBDL162145	1	1 5/16	

BSPP Male x JIC Male - 90°



Part Number	BSPP M	JIC M	
QEBDL0207	1/8	7/16	
QEBDL0209	1/8	9/16	
QEBDL0407	1/4	7/16	
QEBDL0408	1/4	1/2	
QEBDL0409	1/4	9/16	
QEBDL0412	1/4	3/4	
QEBDL0607	3/8	7/16	
QEBDL0609	3/8	9/16	
QEBDL0612	3/8	3/4	
QEBDL0614	3/8	7/8	
QEBDL0809	1/2	9/16	
QEBDL0812	1/2	3/4	
QEBDL0814	1/2	7/8	
QEBDL0817	1/2	1 1/16	
QEBDL12	3/4	3/4	
QEBDL1207	3/4	7/16	
QEBDL1209	3/4	9/16	
QEBDL1214	3/4	7/8	
QEBDL1217	3/4	1 1/16	
QEBDL1221	3/4	1 5/16	
QEBDL1614	1	7/8	
QEBDL1617	1	1 1/16	
QEBDL1621	1	1 5/16	
QEBDL1626	1	1 5/8	
QEBDL2021	1 1/4	1 5/16	
QEBDL2026	1 1/4	1 5/8	
QEBDL2030	1 1/4	1 7/8	
QEBDL2421	1 1/2	1 5/16	
QEBDL2426	1 1/2	1 5/8	

Continued on the following page

BSPM Male x JIC Male - 90° Continued...



Part Number	BSPM M	JIC M	
QEBDL2430	1 1/2	1 7/8	
QEBDL3240	2	2 1/2	

BSPM Male x ORFS Male - 90°

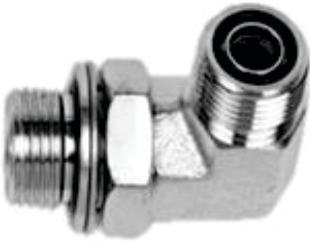

Part Number	BSPM M	ORFS M	
QEBDW0409	1/4	9/16	
QEBDW0411	1/4	11/16	
QEBDW0611	3/8	11/16	
QEBDW0613	3/8	13/16	
QEBDW0813	1/2	13/16	
QEBDW0816	1/2	1	
QEBDW1219	3/4	1 3/16	
QEBDW1623	1	1 7/16	
QEBDW2027	1 1/4	1 11/16	

BSPM Male x Low Pressure Hose Tail - 90°



Part Number	BSPM M	L/P Hosetail	
QEBDX12	3/4	3/4	
QEBDX1216	3/4	1	
QEBDX16	1	1	
QEBDX1620	1	1 1/4	
QEBDX1624	1	1 1/2	
QEBDX20	1 1/4	1 1/4	
QEBDX2024	1 1/4	1 1/2	
QEBDX24	1 1/2	1 1/2	

BSPT Male - 45°



Part Number	BSPT M	BSPT M	
QEBE0245	1/8	1/8	
QEBE0445	1/4	1/4	
QEBE0645	3/8	3/8	
QEBE081245	1/2	3/4	
QEBE0845	1/2	1/2	
QEBE1245	3/4	3/4	
QEBE161245	1	3/4	
QEBE1645	1	1	
QEBE2045	1 1/4	1 1/4	

BSPT Male - 90°



Part Number	BSPT M	BSPT M	
QEBE02	1/8	1/8	
QEBE04	1/4	1/4	
QEBE0402	1/4	1/8	
QEBE06	3/8	3/8	
QEBE0604	3/8	1/4	
QEBE08	1/2	1/2	
QEBE0804	1/2	1/4	
QEBE0806	1/2	3/8	
QEBE12	3/4	3/4	
QEBE1208	3/4	1/2	
QEBE16	1	1	
QEBE1612	1	3/4	
QEBE20	1 1/4	1 1/4	
QEBE2016	1 1/4	1	
QEBE24	1 1/2	1 1/2	
QEBE32	2	2	

BSPT Male x JIC Female Swivel - 90°



Part Number	BSPT M	JIC F	
QEBEK0409	1/4	9/16	
QEBEK0609	3/8	9/16	
QEBEK0812	1/2	3/4	
QEBEK0814	1/2	7/8	

BSPT Male x JIC Male - 45°



Part Number	BSPT M	JIC M	
QEBEL020745	1/8	7/16	
QEBEL040745	1/4	7/16	
QEBEL040945	1/4	9/16	
QEBEL041245	1/4	3/4	
QEBEL060945	3/8	9/16	
QEBEL061245	3/8	3/4	
QEBEL061445	3/8	7/8	
QEBEL080945	1/2	9/16	
QEBEL081245	1/2	3/4	
QEBEL081445	1/2	7/8	
QEBEL081745	1/2	1 1/16	
QEBEL121445	3/4	7/8	
QEBEL121745	3/4	1 1/16	
QEBEL122145	3/4	1 5/16	
QEBEL162145	1	1 5/16	
QEBEL162645	1	1 5/8	

BSPT Male x JIC Male - 90°



Part Number	BSPT M	JIC M	
QEBEL0207	1/8	7/16	
QEBEL0208	1/8	1/2	
QEBEL0209	1/8	9/16	
QEBEL0407	1/4	7/16	
QEBEL0408	1/4	1/2	
QEBEL0409	1/4	9/16	
QEBEL0412	1/4	3/4	
QEBEL0607	3/8	7/16	
QEBEL0609	3/8	9/16	
QEBEL0612	3/8	3/4	
QEBEL0614	3/8	7/8	
QEBEL0807	1/2	7/16	
QEBEL0809	1/2	9/16	
QEBEL0812	1/2	3/4	
QEBEL0814	1/2	7/8	
QEBEL0817	1/2	1 1/16	
QEBEL12	3/4	3/4	
QEBEL1209	3/4	9/16	
QEBEL1214	3/4	7/8	
QEBEL1217	3/4	1 1/16	
QEBEL1221	3/4	1 5/16	
QEBEL1612	1	3/4	
QEBEL1614	1	7/8	
QEBEL1617	1	1 1/16	
QEBEL1621	1	1 5/16	
QEBEL1626	1	1 5/8	
QEBEL2017	1 1/4	1 1/16	
QEBEL2021	1 1/4	1 5/16	
QEBEL2026	1 1/4	1 5/8	
QEBEL2030	1 1/4	1 7/8	
QEBEL2426	1 1/2	1 5/8	
QEBEL2430	1 1/2	1 7/8	
QEBEL3240	2	2 1/2	

BSPT Male x UNO Male - 45°



Part Number	BSPT M	UNO M	
QEBEP040945	1/4	9/16	
QEBEP060945	3/8	9/16	
QEBEP061245	3/8	3/4	
QEBEP081245	1/2	3/4	
QEBEP081445	1/2	7/8	
QEBEP121745	3/4	1 1/16	
QEBEP162145	1	1 5/16	

BSPT Male x UNO Male - 90°



Part Number	BSPT M	UNO M	
QEBEP0409	1/4	9/16	
QEBEP0412	1/4	3/4	
QEBEP0609	3/8	9/16	
QEBEP0612	3/8	3/4	
QEBEP0614	3/8	7/8	
QEBEP0812	1/2	3/4	
QEBEP0814	1/2	7/8	
QEBEP0817	1/2	1 1/16	
QEBEP1214	3/4	7/8	
QEBEP1217	3/4	1 1/16	
QEBEP1621	1	1 5/16	

BSPT Male x Low Pressure Hosetail - 90°



Part Number	BSPT M	L/P Hosetail	
QEBEX0812	1/2	3/4	
QEBEX12	3/4	3/4	
QEBEX1216	3/4	1	
QEBEX16	1	1	
QEBEX1614	1	7/8	
QEBEX1620	1	1 1/4	
QEBEX1624	1	1 1/2	
QEBEX20	1 1/4	1 1/4	
QEBEX2016	1 1/4	1	
QEBEX2018	1 1/4	1 1/8	
QEBEX2024	1 1/4	1 1/2	
QEBEX2032	1 1/4	2	
QEBEX24	1 1/2	1 1/2	
QEBEX2420	1 1/2	1 1/4	
QEBEX2432	1 1/2	2	
QEBEX32	2	2	

JIC Female Swivel x JIC Male - 45°



Part Number	JIC F	JIC M	
QEBKL0745	7/16	7/16	
QEBKL0845	1/2	1/2	
QEBKL0945	9/16	9/16	
QEBKL1245	3/4	3/4	
QEBKL1445	7/8	7/8	
QEBKL1745	1 1/16	1 1/16	
QEBKL2145	1 5/16	1 5/16	
QEBKL2645	1 5/8	1 5/8	
QEBKL3045	1 7/8	1 7/8	
QEBKL4045	2 1/2	2 1/2	

JIC Female Swivel x JIC Male - 90°



Part Number	JIC F	JIC M	
QEBKL07	7/16	7/16	
QEBKL08	1/2	1/2	
QEBKL09	9/16	9/16	
QEBKL12	3/4	3/4	
QEBKL1214	3/4	7/8	
QEBKL14	7/8	7/8	
QEBKL1412	7/8	3/4	
QEBKL1417	7/8	1 1/16	
QEBKL17	1 1/16	1 1/16	
QEBKL21	1 5/16	1 5/16	
QEBKL26	1 5/8	1 5/8	
QEBKL30	1 7/8	1 7/8	
QEBKL40	2 1/2	2 1/2	

JIC Female Swivel x UNO Male - 45°



Part Number	JIC F	UNO M	
QEBKP0945	9/16	9/16	
QEBKP1245	3/4	3/4	
QEBKP1445	7/8	7/8	

JIC Female Swivel x UNO Male - 90°



Part Number	JIC F	UNO M	
QEBKP09	9/16	9/16	
QEBKP0912	9/16	3/4	
QEBKP12	3/4	3/4	
QEBKP1214	3/4	7/8	
QEBKP14	7/8	7/8	
QEBKP17	1 1/16	1 1/16	

JIC Male - 90°



Part Number	JIC M	JIC M	
QEBL07	7/16	7/16	
QEBL09	9/16	9/16	
QEBL1209	3/4	9/16	
QEBL12	3/4	3/4	
QEBL14	7/8	7/8	
QEBL1412	7/8	3/4	
QEBL17	1 1/16	1 1/16	
QEBL1714	1 1/16	7/8	
QEBL21	1 5/16	1 5/16	

Continued on the following page

JIC Male - 90° Continued...



Part Number	JIC M	JIC M	
QEBL26	1 5/8	1 5/8	
QEBL30	1 7/8	1 7/8	

JIC Male x UNO Male - 45°



Part Number	JIC M	UNO M	
QEBLP0745	7/16	7/16	
QEBLP091245	9/16	3/4	
QEBLP0945	9/16	9/16	
QEBLP120945	3/4	9/16	
QEBLP121445	3/4	7/8	
QEBLP121745	3/4	1 1/16	
QEBLP1245	3/4	3/4	
QEBLP141245	7/8	3/4	
QEBLP1445	7/8	7/8	
QEBLP171245	1 1/16	3/4	
QEBLP171445	1 1/16	7/8	
QEBLP172145	1 1/16	1 5/16	
QEBLP1745	1 1/16	1 1/16	
QEBLP211745	1 5/16	1 1/16	
QEBLP212645	1 5/16	1 5/8	
QEBLP2145	1 5/16	1 5/16	
QEBLP2645	1 5/8	1 5/8	

JIC Male x UNO Male - 90°



Part Number	JIC M	UNO M	
QEBLP07	7/16	7/16	
QEBLP0709	7/16	9/16	
QEBLP0712	7/16	3/4	
QEBLP08	1/2	1/2	
QEBLP09	9/16	9/16	
QEBLP0907	9/16	7/16	
QEBLP0912	9/16	3/4	
QEBLP0914	9/16	7/8	
QEBLP0917	9/16	1 1/16	
QEBLP12	3/4	3/4	
QEBLP1207	3/4	7/16	
QEBLP1209	3/4	9/16	
QEBLP1214	3/4	7/8	
QEBLP1217	3/4	1 1/16	
QEBLP1221	3/4	1 5/16	

Continued on the following page

JIC Male x UNO Male - 90° Continued...



Part Number	JIC M	UNO M	
QEBLP14	7/8	7/8	
QEBLP1409	7/8	9/16	
QEBLP1412	7/8	3/4	
QEBLP1417	7/8	1 1/16	
QEBLP1421	7/8	1 5/16	
QEBLP17	1 1/16	1 1/16	
QEBLP1712	1 1/16	3/4	
QEBLP1714	1 1/16	7/8	
QEBLP1721	1 1/16	1 5/16	
QEBLP1726	1 1/16	1 5/8	
QEBLP1730	1 1/16	1 7/8	
QEBLP21	1 5/16	1 5/16	
QEBLP2114	1 5/16	7/8	
QEBLP2117	1 5/16	1 1/16	
QEBLP2126	1 5/16	1 5/8	
QEBLP26	1 5/8	1 5/8	
QEBLP2621	1 5/8	1 5/16	
QEBLP30	1 7/8	1 7/8	

JIC Male x Metric Male - 90°



Part Number	JIC M	Metric M	
QEBLR0914	9/16	14mm x1.5	
QEBLR0916	9/16	16mm x 1.5	
QEBLR0918	9/16	18mm x 1.5	
QEBLR1216	3/4	16mm x 1.5	
QEBLR1218	3/4	18mm x 1.5	
QEBLR1222	3/4	22mm x 1.5	
QEBLR1420	7/8	20mm x 1.5	
QEBLR1422	7/8	22mm x1.5	
QEBLR1722	1 1/16	22mm x 1.5	
QEBLR1727	1 1/16	27mm x 2	
QEBLR2127	1 5/16	27mm x 2	
QEBLR2133	1 5/16	33mm x 2	
QEBLR2642	1 5/8	42mm x 2	

JIC Male x NPT Male - 45°



Part Number	JIC M	NPT M	
QEBLU070245	7/16	1/8	
QEBLU070445	7/16	1/4	
QEBLU090645	9/16	3/8	
QEBLU120445	3/4	1/4	
QEBLU120845	3/4	1/2	
QEBLU140845	7/8	1/2	
QEBLU171245	1 1/16	3/4	
QEBLU211645	1 5/16	1	
QEBLU403245	2 1/2	2	

Can't find what you're looking for? Contact us -



1300 654 782



07 5428 1311

All part numbers displayed in **BOLD ITALICS** are new items that may not be in stock as yet, please contact us for further details.

JIC Male x NPT Male - 90°



Part Number	JIC M	NPT M	
QEBLU0702	7/16	1/8	
QEBLU0704	7/16	1/4	
QEBLU0904	9/16	1/4	
QEBLU0906	9/16	3/8	
QEBLU0908	9/16	1/2	
QEBLU0912	9/16	3/4	
QEBLU12	3/4	3/4	
QEBLU1206	3/4	3/8	
QEBLU1208	3/4	1/2	
QEBLU1712	1 1/16	3/4	
QEBLU1716	1 1/16	1	
QEBLU2116	1 5/16	1	
QEBLU2120	1 5/16	1 1/4	
QEBLU2124	1 5/16	1 1/2	
QEBLU2620	1 5/8	1 1/4	
QEBLU4032	2 1/2	2	

Komatsu JIS Metric Male x Komatsu JIS Metric Male Swivel - 90°



Part Number	JIS F (Metric)	JIS M (Metric)	
QEBMN14	14mm x 1.5	14mm x 1.5	
QEBMN16	16mm x 1.5	16mm x 1.5	
QEBMN18	18mm x 1.5	18mm x 1.5	
QEBMN22	22mm x 1.5	22mm x 1.5	
QEBMN24	24mm x 1.5	24mm x 1.5	
QEBMN30	30mm x 1.5	30mm x 1.5	

UNO Male x ORFS Male - 45°



Part Number	UNO M	ORFS M	
QEBPW0945	9/16	9/16	
QEBPW121345	3/4	13/16	

UNO Male x ORFS Male - 90°



Part Number	UNO M	ORFS M	
QEBPW0709	7/16	9/16	
QEBPW0711	7/16	11/16	
QEBPW09	9/16	9/16	
QEBPW0911	9/16	11/16	
QEBPW0913	9/16	13/16	
QEBPW1211	3/4	11/16	

Continued on the following page

UNO Male x ORFS Male - 90° Continued...



Part Number	UNO M	ORFS M	
QEBPW1213	3/4	13/16	
QEBPW1413	7/8	13/16	
QEBPW1416	7/8	1	
QEBPW1713	1 1/16	13/16	
QEBPW1719	1 1/16	1 3/16	
QEBPW2119	1 5/16	1 3/16	
QEBPW2123	1 5/16	1 7/16	
QEBPW2127	1 5/16	1 7/16	

UNO Male x Low Pressure Hose Tail - 90°

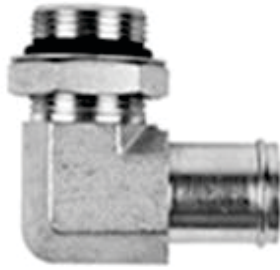

Part Number	UNO M	L/P Hosetail	
QEBPX1712	1 1/16	3/4	
QEBPX1716	1 1/16	1	
QEBPX2116	1 5/16	1	
QEBPX2120	1 5/16	1 1/4	
QEBPX2124	1 5/16	1 1/2	
QEBPX2620	1 5/8	1 1/4	
QEBPX2624	1 5/8	1 1/2	
QEBPX3024	1 7/8	1 1/2	

SAE Female Swivel x SAE Male - 90°



Part Number	SAE F	SAE M	
QEBSFSM10	5/8	5/8	

NPT Female - 45°



Part Number	NPT F	NPT F	
QEBTS0445	1/4	1/4	
QEBTS0645	3/4	3/8	

NPT Female - 90°



Part Number	NPT F	NPT F	
QEBTS02	1/8	1/8	
QEBTS04	1/4	1/4	
QEBTS06	3/8	3/8	
QEBTS08	1/2	1/2	
QEBTS12	3/4	3/4	
QEBTS16	1	1	
QEBTS20	1 1/4	1 1/4	
QEBTS32	2	2	

NPT Female Solid x NPT Male - 45°



Part Number	NPT F	NPT M	
QEBTSU0245	1/8	1/8	
QEBTSU0445	1/4	1/4	
QEBTSU1245	3/4	3/4	

NPT Female Solid x NPT Male - 90°



Part Number	NPT F	NPT M	
QEBTSU02	1/8	1/8	
QEBTSU04	1/4	1/4	
QEBTSU06	3/8	3/8	
QEBTSU08	1/2	1/2	
QEBTSU12	3/4	3/4	
QEBTSU16	1	1	

NPT Female Swivel x NPT Male - 90°



Part Number	NPT F	NPT M	
QEBTU02	1/8	1/8	
QEBTU04	1/4	1/4	
QEBTU06	3/8	3/8	

NPT Male - 45°



Part Number	NPT M	NPT M	
QEBU1645	1	1	

NPT Male - 90°

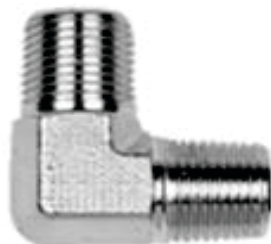

Part Number	NPT M	NPT M	
QEBU04	1/4	1/4	
QEBU06	3/8	3/8	
QEBU0604	1/4	3/8	
QEBU08	1/2	1/2	
QEBU0806	3/8	1/2	
QEBU12	3/4	3/4	
QEBU16	1	1	

ORFS Female Swivel x ORFS Male - 45°



Part Number	ORFS F	ORFS M	
QEBVW0945	9/16	9/16	
QEBVW1145	11/16	11/16	
QEBVW1345	13/16	13/16	
QEBVW1645	1	1	
QEBVW1945	1 3/16	1 3/16	
QEBVW2345	1 7/16	1 7/16	
QEBVW2745	1 11/16	1 11/16	

ORFS Female Swivel x ORFS Male - 90°

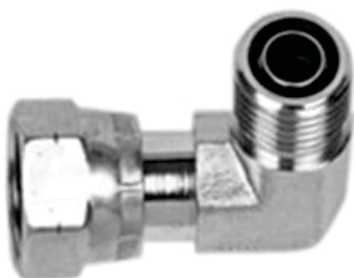

Part Number	ORFS F	ORFS M	
QEBVW09	9/16	9/16	
QEBVW11	11/16	11/16	
QEBVW13	13/16	13/16	
QEBVW16	1	1	
QEBVW19	1 3/16	1 3/16	
QEBVW23	1 7/16	1 7/16	
QEBVW27	1 11/16	1 11/16	

ORFS Male - 90°



Part Number	ORFS M	ORFS M	
QEBW09	9/16	9/16	
QEBW11	11/16	11/16	
QEBW16	1	1	
QEBW19	1 3/16	1 3/16	

Can't find what you're looking for? Contact us -



1300 654 782



07 5428 1311

All part numbers displayed in **BOLD ITALICS** are new items that may not be in stock as yet, please contact us for further details.

ADAPTORS (QEL) Long Tube Elbow

BSPT Male - 90°

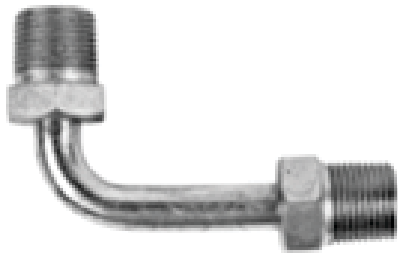

Part Number	BSPT M	BSPT M	
QELE06	3/8	3/8	

Code 61 Flange x JIC Male - 90° Long Drop



Part Number	C61 Flange	JIC M	
QELFL1217D96	3/4	1 1/16	
QELFL1621D117	1	1 5/16	
QELFL2026D130	1 1/4	1 5/8	

Code 62 Flange x JIC Male - 5000 psi - 90° Long Drop



Part Number	C62 Flange	JIC M	
QELGL1217D96	3/4	1 1/16	
QELGL1621D117	1	1 5/16	
QELGL2026D130	1 1/4	1 5/8	

JIC Female Swivel x JIC Male - 90° Long Drop



Part Number	JIC F	JIC M	
QELKL07	7/16	7/16	
QELKL09	9/16	9/16	
QELKL12	3/4	3/4	
QELKL14	7/8	7/8	
QELKL17	1 1/16	1 1/16	
QELKL21	1 5/16	1 5/16	
QELKL26	1 5/8	1 5/8	

ADAPTORS (QET) Short Tube Elbow

Code 61 Flange x JIC Male - 45°



Part Number	C61 Flange	JIC M	
QETFL081245	1/2	3/4	
QETFL121445	3/4	7/8	
QETFL121745	3/4	1 1/16	
QETFL122145	3/4	1 5/16	
QETFL161745	1	1 1/16	
QETFL162145	1	1 5/16	
QETFL202145	1 1/4	1 5/16	
QETFL202645	1 1/4	1 5/8	
QETFL242645	1 1/2	1 5/8	
QETFL243045	1 1/2	1 7/8	
QETFL324045	2	2 1/2	

Code 61 Flange x JIC Male - 90°



Part Number	C61 Flange	JIC M	
QETFL0812	1/2	3/4	
QETFL12	3/4	3/4	
QETFL1214	3/4	7/8	
QETFL1217	3/4	1 1/16	
QETFL1221	3/4	1 5/16	
QETFL1617	1	1 1/16	
QETFL1621	1	1 5/16	
QETFL2021	1 1/4	1 5/16	
QETFL2026	1 1/4	1 5/8	
QETFL2426	1 1/2	1 5/8	
QETFL2430	1 1/2	1 7/8	
QETFL3240	2	2 1/2	

Code 61 Flange x Low Pressure Hosetail - 45°



Part Number	C61 Flange	L/P Hosetail	
QETFX242445	1 1/2	1 1/2	
QETFX323245	2	2	
QETFX403245	2 1/2	2	

Code 61 Flange x Low Pressure Hosetail - 90°



Part Number	C61 Flange	L/P Hosetail	
QETFX2020	1 1/14	1 1/4	
QETFX2424	1 1/2	1 1/2	
QETFX2432	1 1/2	2	
QETFX3232	2	2	
QETFX4032	2 1/2	2	

Code 62 Flange x JIC Male - 5000 psi - 45°



Part Number	C62 Flange	JIC M	
QETGL121745	3/4	1 1/16	
QETGL122145	3/4	1 5/16	
QETGL161745	1	1 1/16	
QETGL162145	1	1 5/16	
QETGL202145	1 1/4	1 5/16	
QETGL202645	1 1/4	1 5/8	
QETGL242645	1 1/2	1 5/8	
QETGL243045	1 1/2	1 7/8	

Code 62 Flange x JIC Male - 5000 psi - 90°



Part Number	C62 Flange	JIC M	
QETGL1217	3/4	1 1/16	
QETGL1221	3/4	1 5/16	
QETGL1617	1	1 1/16	
QETGL1621	1	1 5/16	
QETGL2021	1 1/4	1 5/16	
QETGL2026	1 1/4	1 5/8	
QETGL2426	1 1/2	1 5/8	
QETGL2430	1 1/2	1 7/8	
QETGL2017	1 1/4	1 1/16	
QETGL3240	2	2 1/2	

Code 62 Flange x ORFS Male - 5000 psi - 45°



Part Number	C62 Flange	ORFS M	
QETGW162345	1	1 7/16	

Code 62 Flange x ORFS Male - 5000 psi - 90°



Part Number	C62 Flange	ORFS M	
QETGW1219	3/4	1 3/16	
QETGW1223	3/4	1 7/16	
QETGW1623	1	1 7/16	
QETGW2027	1 1/4	1 11/16	

JIC Female x JIC Male - 45°



Part Number	JIC F	JIC M	
QETKL0745	7/16	7/16	
QETKL0945	9/16	9/16	
QETKL1245	3/4	3/4	
QETKL1445	7/8	7/8	
QETKL1745	1 1/16	1 1/16	
QETKL211745	1 5/16	1 1/16	
QETKL2145	1 5/16	1 5/16	
QETKL2645	1 5/8	1 5/8	

JIC Female x JIC Male - 90°



Part Number	JIC F	JIC M	
QETKL07	7/16	7/16	
QETKL09	9/16	9/16	
QETKL12	3/4	3/4	
QETKL14	7/8	7/8	
QETKL17	1 1/16	1 1/16	
QETKL21	1 5/16	1 5/16	
QETKL26	1 5/8	1 5/8	
QETKL30	1 7/8	1 7/8	

ADAPTORS (QFB) Flange Blanking Plug

Code 61 Flange



Part Number	C61 Flange	
QFBF08	1/2	<i>Used With QFCF Clamps</i>
QFBF12	3/4	
QFBF16	1	
QFBF20	1 1/4	
QFBF24	1 1/2	
QFBF32	2	

Code 62 Flange

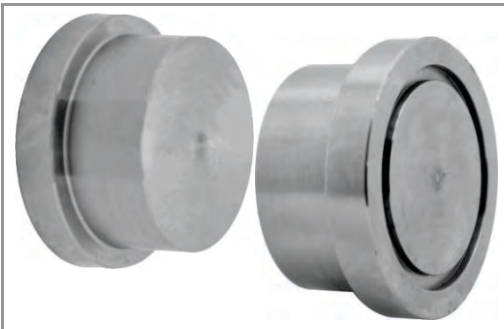

Part Number	C61 Flange	
QFBG08	1/2	<i>Used With QFCG Clamps</i>
QFBG12	3/4	
QFBG16	1	
QFBG20	1 1/4	
QFBG24	1 1/2	
QFBG32	2	

Code 61 Flange Blanking Plate - UNC



Part Number	C61 Flange		
QFBF12-B-UNC	3/4		
QFBF16-B-UNC	1		
QFBF20-B-UNC	1 1/4		
QFBF24-B-UNC	1 1/2		
QFBF32-B-UNC	2		

Inc. UNC Threaded Bolt Holes

Code 62 Flange Blanking Plate - UNC



Part Number	C62 Flange		
QFBG12-B-UNC	3/4		
QFBG16-B-UNC	1		
QFBG20-B-UNC	1 1/4		
QFBG24-B-UNC	1 1/2		
QFBG32-B-UNC	2		

Inc. UNC Threaded Bolt Holes

ADAPTORS (QFC) Flange Clamps

Code 61 Flange Clamp



Part Number	C61 Flange		
QFCF08	1/2		
QFCF12	3/4		
QFCF16	1		
QFCF20	1 1/4		
QFCF24	1 1/2		
QFCF32	2		
QFCF40	2 1/2		
QFCF48	3		

Code 61 Flange Clamp - Including Bolt Set - UNC



Part Number	C61 Flange	UNC
QFCF08-UNC	1/2	5/16 x 18 1 1/4
QFCF12-UNC	3/4	3/8 x 16 x 1 1/4
QFCF16-UNC	1	3/8 x 16 x 1 1/4
QFCF20-UNC	1 1/4	7/16 x 14 x 1 1/2
QFCF24-UNC	1 1/2	1/2 x 13 x 1 1/2
QFCF32-UNC	2	1/2 x 13 x 1 1/2
QFCF40-UNC	2 1/2	1/2 x 13 x 1 3/4
QFCF48-UNC	3	5/8 x 11 x 1 3/4

Code 61 Flange Clamp - Including (Allen Head) Bolt Set - Metric



Part Number	C61 Flange	UNC
QFCF12-METRIC	3/4	10mm x 1.5 x 30
QFCF16-METRIC	1	10mm x 1.5 x 30
QFCF20-METRIC	1 1/4	10mm x 1.5 x 30
QFCF24-METRIC	1 1/2	12mm x 1.75 x 40
QFCF32-METRIC	2	12mm x 1.75 x 40

Code 61 Hex Bolt Set - UNC



Part Number	C61 Flange	UNC
QFCF08-BOLT-UNC	1/2	5/16 x 18 1 1/4
QFCF12/16-BOLT-UNC	3/4 - 1	3/8 x 16 x 1 1/4
QFCF20-BOLT-UNC	1 1/4	7/16 x 14 x 1 1/2
QFCF24/32-BOLT-UNC	1 1/2 - 2	1/2 x 13 x 1 1/2
QFCF40-BOLT-UNC	2 1/2	1/2 x 13 x 1 3/4

Code 61 Allen Head Bolt Set Metric



Part Number	C61 Flange	Metric
QFCF08-BOLT-C-M	1/2	8mm x 1.25 x 30
QFCF12/16-BOLT-C-M	3/4 - 1	10mm x 1.5 x 30
QFCF20-BOLT-C-M	1 1/4	10mm x 1.5 x 40
QFCF24/32-BOLT-C-M	1 1/2 - 2	12mm x 1.75 x 40

Code 62 Flange Clamp



Part Number	C62 Flange		
QFCG08	1/2		
QFCG12	3/4		
QFCG16	1		
QFCG20	1 1/4		
QFCG24	1 1/2		
QFCG32	2		

Code 62 Flange Including Bolt Set - UNC



Part Number	C62 Flange	UNC
QFCG12-UNC	3/4	3/8 x 16 x 1 1/2
QFCG16-UNC	1	7/16 x 14 x 1 3/4
QFCG20-UNC	1 1/4	1/2 x 13 x 3/4
QFCG24-UNC	1 1/2	5/8 x 11 x 2 1/4
QFCG32-UNC	2	3/4 x 10 x 2 3/4

Code 62 Flange Including Bolt Set - Metric



Part Number	C62 Flange	Metric
QFCG12-METRIC	3/4	10mm x 1.5 x 35
QFCG16-METRIC	1	12mm x 1.75 x 45
QFCG20-METRIC	1 1/4	14mm x 2 x 45
QFCG24-METRIC	1 1/2	16mm x 2 x 55
QFCG32-METRIC	2	20mm x 2.5 x 70

Code 62 Flange Bolt Set ONLY- UNC



Part Number	C62 Flange	UNC
QFCG12-BOLT-UNC	3/4	3/8 x 16 x 1 1/2
QFCG16-BOLT-UNC	1	7/16 x 14 x 1 3/4
QFCG20-BOLT-UNC	1 1/4	1/2 x 13 x 1 3/4
QFCG24-BOLT-UNC	1 1/2	5/8 x 11 x 2 1/4
QFCG32-BOLT-UNC	2	3/4 x 10 x 2 3/4

Code 62 Flange Bolt Set ONLY - Metric



Part Number	C62 Flange	Metric
QFCG12-BOLT-C-M	3/4	10mm x 1.5 x 35
QFCG16-BOLT-C-M	1	12mm x 1.75 x 45
QFCG20-BOLT-C-M	1 1/4	14mm x 2 x 45
QFCG24-BOLT-C-M	1 1/2	16mm x 2 x 55
QFCG32-BOLT-C-M	2	20mm x 2.5 x 70

Caterpillar Flange Clamp - NO BOLTS

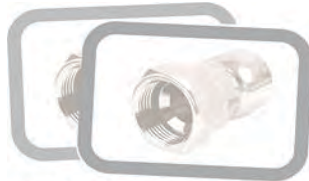

PICTURE NOT AVAILABLE

Part Number	Cat Flange		
QFCG12CAT-UNC	3/4		
QFCG16CAT-UNC	1		
QFCG20CAT-UNC	1 1/4		
QFCG24CAT-UNC	1 1/2		
QFCG32CAT-UNC	2		

ADAPTORS (QLEB) Extended Elbow

JIC Male x UNO Male Extended Elbow - 90°

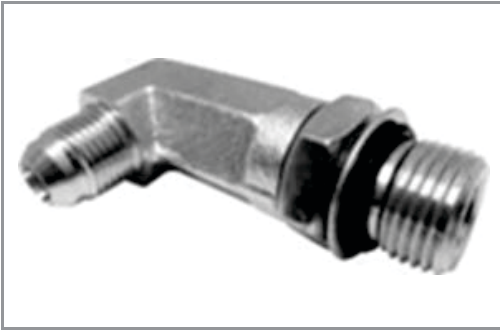

Part Number	JIC M	UNO M	Drop Length
QLEBLP12-E73	3/4	7/8	73mm
QLEBLP1214-E73	3/4	7/8	73mm
QLEBLP1412-E73	7/8	3/4	73mm
QLEBLP1414-E73	7/8	7/8	73mm

JIC Male x NPT Male Extended Elbow - 90°



Part Number	JIC M	NPT M	Drop Length
QLEBLU0702-E30	7/16	1/8	30mm
QLEBLU0702-E40	7/16	1/8	40mm
QLEBLU0704-E40	7/16	1/4	40mm

ADAPTORS (QNE) Extended Nipple

JIC Male x UNO Male Extended Nipple



Part Number	JIC M	UNO M	
QNELP09	9/16	9/16	
QNELP12	3/4	3/4	
QNELP14	7/8	7/8	
QNELP17	1 1/16	1 1/16	
QNELP21	1 5/16	1 5/16	

ADAPTORS (QNI) Nipple

BSPP Male



NOTE: Please advise which size seal is required when ordering.

NO ADDITIONAL CHARGE!!

Default will be the largest end.

Part Number	BSPP M	BSPP M	
QNID04	1/4	1/4	
QNID06	3/8	3/8	
QNID0604	3/8	1/4	
QNID08	1/2	1/2	
QNID0804	1/2	1/4	
QNID0806	1/2	3/8	
QNID12	3/4	3/4	
QNID1206	3/4	3/8	
QNID1208	3/4	1/2	
QNID16	1	1	
QNID1608	1	1/2	
QNID1612	1	3/4	
QNID20	1 1/4	1 1/4	
QNID2016	1 1/4	1	
QNID24	1 1/2	1 1/2	
QNID2420	1 1/2	1 1/4	
QNID32	2	2	
QNID3224	2	1 1/2	

BSPP Male x BSPT Male



Part Number	BSPP M	BSPT M	
QNIDE04	1/4	1/4	
QNIDE0402	1/4	1/8	
QNIDE0406	1/4	3/8	
QNIDE06	3/8	3/8	
QNIDE0604	3/8	1/4	
QNIDE0608	3/8	1/2	
QNIDE0612	3/8	3/4	
QNIDE08	1/2	1/2	
QNIDE0806	1/2	3/8	
QNIDE0812	1/2	3/4	
QNIDE12	3/4	3/4	
QNIDE1208	3/4	1/2	
QNIDE1216	3/4	1	
QNIDE16	1	1	
QNIDE1612	1	3/4	
QNIDE20	1 1/4	1 1/4	
QNIDE2012	1 1/4	3/4	
QNIDE2016	1 1/4	1	
QNIDE2024	1 1/4	1 1/2	
QNIDE24	1 1/2	1 1/2	
QNIDE32	2	2	

BSPP Male x JIC Male



Part Number	BSPP M	JIC M	
QNIDL0207	1/8	7/16	
QNIDL0209	1/8	9/16	
QNIDL0407	1/4	7/16	
QNIDL0408	1/4	1/2	
QNIDL0409	1/4	9/16	
QNIDL0412	1/4	3/4	
QNIDL0607	3/8	7/16	
QNIDL0609	3/8	9/16	
QNIDL0612	3/8	3/4	
QNIDL0614	3/8	7/8	
QNIDL0617	3/8	1 1/16	
QNIDL0809	1/2	9/16	
QNIDL0812	1/2	3/4	
QNIDL0814	1/2	7/8	
QNIDL0817	1/2	1 1/16	
QNIDL0821	1/2	1 5/16	
QNIDL12	3/4	3/4	
QNIDL1209	3/4	9/16	
QNIDL1214	3/4	7/8	
QNIDL1217	3/4	1 1/16	
QNIDL1221	3/4	1 5/16	
QNIDL1226	3/4	1 5/8	
QNIDL1612	1	3/4	
QNIDL1614	1	7/8	
QNIDL1617	1	1 1/16	
QNIDL1621	1	1 5/16	
QNIDL1626	1	1 5/8	
QNIDL1630	1	1 7/8	
QNIDL2017	1 1/4	1 1/16	
QNIDL2021	1 1/4	1 5/16	
QNIDL2026	1 1/4	1 5/8	
QNIDL2030	1 1/4	1 7/8	
QNIDL2421	1 1/2	1 5/16	
QNIDL2426	1 1/2	1 5/8	
QNIDL2430	1 1/2	1 7/8	
QNIDL3226	2	1 5/8	
QNIDL3230	2	1 7/8	
QNIDL3240	2	2 1/2	

BSPP Male x NPT Male



Part Number	BSPP M	NPT M	
QNIDU04	1/4	1/4	
QNIDU06	3/8	3/8	
QNIDU12	3/4	3/4	

BSPP Male x ORFS Male



Part Number	BSPP M	ORFS M	
QNIDW0409	1/4	9/16	
QNIDW0411	1/4	11/16	
QNIDW0609	3/8	9/16	
QNIDW0611	3/8	11/16	
QNIDW0613	3/8	13/16	
QNIDW0811	1/2	11/16	
QNIDW0813	1/2	13/16	
QNIDW0816	1/2	1	
QNIDW1213	3/4	13/16	
QNIDW1216	3/4	1	
QNIDW1219	3/4	1 3/16	
QNIDW1619	1	1 3/16	
QNIDW1623	1	1 7/16	
QNIDW1627	1	1 11/16	
QNIDW2027	1 1/4	1 11/16	
QNIDW2427	1 1/2	1 11/16	

BSPT Male



Part Number	BSPT M	BSPT M	
QNIE02	1/8	1/8	
QNIE04	1/4	1/4	
QNIE0402	1/4	1/8	
QNIE06	3/8	3/8	
QNIE0602	3/8	1/8	
QNIE0604	3/8	1/4	
QNIE08	1/2	1/2	
QNIE0804	1/2	1/4	
QNIE0806	1/2	3/8	
QNIE10	5/8	5/8	
QNIE1008	5/8	1/2	
QNIE12	3/4	3/4	
QNIE1206	3/4	3/8	
QNIE1208	3/4	1/2	
QNIE1210	3/4	5/8	
QNIE12SS	3/4	3/4	STAINLESS

Continued on the following page

BSPT Male Continued...



Part Number	BSPT M	BSPT M	
QNIE16	1	1	
QNIE1606	1	3/8	
QNIE1608	1	1/2	
QNIE1612	1	3/4	
QNIE20	1 1/4	1 1/4	
QNIE2012	1 1/4	3/4	
QNIE2016	1 1/4	1	
QNIE24	1 1/2	1 1/2	
QNIE2412	1 1/2	3/4	
QNIE2416	1 1/2	1	
QNIE2420	1 1/2	1 1/4	
QNIE32	2	2	
QNIE32 BS	2	2	BLACK STEEL
QNIE3220	2	1 1/4	
QNIE3224	2	1 1/2	
QNIE40	2 1/2	2 1/2	
QNIE48	3	3	

BSPT Male x JIC Male



Part Number	BSPT M	JIC M	
QNIEL0207	1/8	7/16	
QNIEL0208	1/8	1/2	
QNIEL0209	1/8	9/16	
QNIEL0407	1/4	7/16	
QNIEL0408	1/4	1/2	
QNIEL0409	1/4	9/16	
QNIEL0412	1/4	3/4	
QNIEL0607	3/8	7/16	
QNIEL0608	3/8	1/2	
QNIEL0609	3/8	9/16	
QNIEL0612	3/8	3/4	
QNIEL0614	3/8	7/8	
QNIEL0617	3/8	1 1/16	
QNIEL0807	1/2	7/16	
QNIEL0809	1/2	9/16	
QNIEL0812	1/2	3/4	
QNIEL0814	1/2	7/8	
QNIEL0817	1/2	1 1/16	
QNIEL0821	1/2	1 5/16	
QNIEL12	3/4	3/4	
QNIEL1209	3/4	9/16	
QNIEL1214	3/4	7/8	
QNIEL1217	3/4	1 1/16	
QNIEL1219	3/4	1 3/16	
QNIEL1221	3/4	1 5/16	
QNIEL1612	1	3/4	

Continued on the following Page

BSPT Male x JIC Male Continued...



Part Number	BSPT M	JIC M	
QNIEL1614	1	7/8	
QNIEL1617	1	1 1/16	
QNIEL1621	1	1 5/16	
QNIEL1626	1	1 5/8	
QNIEL2017	1 1/4	1 1/16	
QNIEL2021	1 1/4	1 5/16	
QNIEL2026	1 1/4	1 5/8	
QNIEL2030	1 1/4	1 7/8	
QNIEL2421	1 1/2	1 5/16	
QNIEL2426	1 1/2	1 5/8	
QNIEL2430	1 1/2	1 7/8	
QNIEL2440	1 1/2	2 1/2	
QNIEL3226	2	1 5/8	
QNIEL3230	2	1 7/8	
QNIEL3240	2	2 1/2	

BSPT Male x JIS Metric (Komatsu) Male

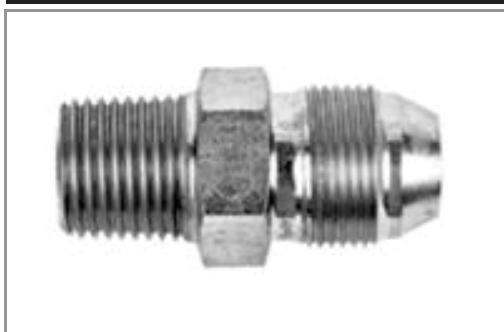

Part Number	BSPT M	JIS M (Metric)	
QNIEN0414	1/4	14mm	
QNIEN0616	3/8	16mm	
QNIEN0618	3/8	18mm	
QNIEN0622	3/8	22mm	
QNIEN0818	1/2	18mm	
QNIEN0820	1/2	20mm	
QNIEN0822	1/2	22mm	
QNIEN0824	1/2	24mm	
QNIEN1224	3/4	24mm	
QNIEN1230	3/4	30mm	
QNIEN1633	1	33mm	

BSPT Male x UNO Male



Part Number	BSPT M	UNO M	
QNIEP0407	1/4	7/16	
QNIEP0409	1/4	9/16	
QNIEP0412	1/4	3/4	
QNIEP0609	3/8	9/16	
QNIEP0612	3/8	3/4	
QNIEP0614	3/8	7/8	
QNIEP0809	1/2	9/16	
QNIEP0812	1/2	3/4	
QNIEP0814	1/2	7/8	
QNIEP0817	1/2	1 1/16	
QNIEP1214	3/4	7/8	
QNIEP1217	3/4	1 1/16	
QNIEP1221	3/4	1 5/16	

Continued on the following page

BSPT Male x UNO Male Continued...



Part Number	BSPT M	UNO M	
QNI EP1617	1	1 1/16	
QNI EP1621	1	1 5/16	
QNI EP2026	1 1/4	1 5/8	
QNI EP2426	1 1/2	1 5/8	

BSPT Male x Metric Male



Part Number	BSPT M	Metric M	
QNI ER0412	1/4	12mm x 1.5	
QNI ER0414	1/4	14mm x 1.5	
QNI ER0620	3/8	20mm x 1.5	
QNI ER0822	1/2	22mm x 1.5	
QNI ER0826	1/2	26mm x 1.5	
QNI ER0827	1/2	27mm x 1.5	
QNI ER1226	3/4	26mm x 1.5	
QNI ER1622	1	22mm x 1.5	

BSPT Male x NPT Male

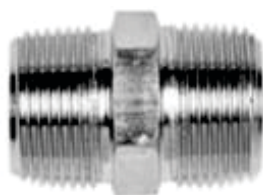

Part Number	BSPT M	NPT M	
QNI EU04	1/4	1/4	
QNI EU06	3/8	3/8	
QNI EU16	1	1	
QNI EU20	1 1/4	1 1/4	
QNI EU24	1 1/2	1 1/2	
QNI EU2420	1 1/2	1 1/4	
QNI EU32	2	2	

JIC Male



Part Number	JIC M	JIC M	
QNI L07	7/16	7/16	
QNI L08	1/2	1/2	
QNI L09	9/16	9/16	
QNI L0907	9/16	7/16	
QNI L12	3/4	3/4	
QNI L1207	3/4	7/16	
QNI L1209	3/4	9/16	
QNI L14	7/8	7/8	
QNI L1412	7/8	3/4	
QNI L17	1 1/16	1 1/16	
QNI L1707	1 1/16	7/16	
QNI L1709	1 1/16	9/16	
QNI L1712	1 1/16	3/4	
QNI L1714	1 1/16	7/8	

Continued on the following page

JIC Male Continued...



Part Number	JIC M	JIC M	
QNIL21	1 5/16	1 5/16	
QNIL2114	1 5/16	7/8	
QNIL2117	1 5/16	1 1/16	
QNIL2126	1 5/16	1 5/8	
QNIL26	1 5/8	1 5/8	
QNIL30	1 7/8	1 7/8	
QNIL40	2 1/2	2 1/2	

JIC Male x UNO Male

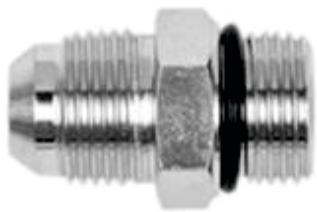

Part Number	JIC M	UNO M	
QNILP07	7/16	7/16	
QNILP0706	7/16	3/8	
QNILP0708	7/16	1/2	
QNILP0709	7/16	9/16	
QNILP0712	7/16	3/4	
QNILP08	1/2	1/2	
QNILP0807	1/2	7/16	
QNILP0809	1/2	9/16	
QNILP09	9/16	9/16	
QNILP0907	9/16	7/16	
QNILP0908	9/16	1/2	
QNILP0912	9/16	3/4	
QNILP0914	9/16	7/8	
QNILP0917	9/16	1 1/16	
QNILP12	3/4	3/4	
QNILP1207	3/4	7/16	
QNILP1209	3/4	9/16	
QNILP1214	3/4	7/8	
QNILP1217	3/4	1 1/16	
QNILP1221	3/4	1 5/16	
QNILP14	7/8	7/8	
QNILP1409	7/8	9/16	
QNILP1412	7/8	3/4	
QNILP1417	7/8	1 1/16	
QNILP1421	7/8	1 5/16	
QNILP17	1 1/16	1 1/16	
QNILP1712	1 1/16	3/4	
QNILP1714	1 1/16	7/8	
QNILP1721	1 1/16	1 5/16	
QNILP1726	1 1/16	1 5/8	
QNILP19	1 3/16	1 3/16	
QNILP1921	1 3/16	1 5/16	
QNILP21	1 5/16	1 5/16	
QNILP2112	1 5/16	3/4	
QNILP2114	1 5/16	7/8	
QNILP2117	1 5/16	1 1/16	

More Part Numbers on the Following Page

JIC Male x UNO Male Continued...

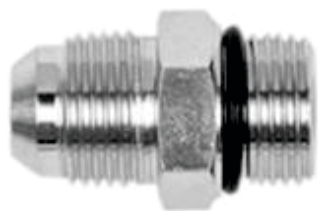

Part Number	JIC M	UNO M	
QNILP2126	1 5/16	1 5/8	
QNILP2130	1 5/16	1 7/8	
QNILP26	1 5/8	1 5/8	
QNILP2617	1 5/8	1 1/16	
QNILP2621	1 5/8	1 5/16	
QNILP2630	1 5/8	1 7/8	
QNILP2640	1 5/8	2 1/2	
QNILP30	1 7/8	1 7/8	
QNILP3040	1 7/8	2 1/2	
QNILP40	2 1/2	2 1/2	

JIC Male x Metric Male



Part Number	JIC M	Metric M	
QNILR0708	7/16	8mm x 1	
QNILR0710	7/16	10mm x 1	
QNILR0712	7/16	12mm x 1.5	
QNILR0714	7/16	14mm x 1.5	
QNILR0912	9/16	12mm x 1.5	
QNILR0914	9/16	14mm x 1.5	
QNILR0916	9/16	16mm x 1.5	
QNILR0918	9/16	18mm x 1.5	
QNILR12	3/4	12mm x 1.5	
QNILR1214	3/4	14mm x 1.5	
QNILR1216	3/4	16mm x 1.5	
QNILR1218	3/4	18mm x 1.5	
QNILR1220	3/4	20mm x 1.5	
QNILR1222	3/4	22mm x 1.5	
QNILR1224	3/4	24mm x 1.5	
QNILR1416	7/8	16mm x 1.5	
QNILR1418	7/8	18mm x 1.5	
QNILR1420	7/8	20mm x 1.5	
QNILR1422	7/8	22mm x 1.5	
QNILR1718	1 1/16	18mm x 1.5	
QNILR1720	1 1/16	20mm x 1.5	
QNILR1722	1 1/16	22mm x 1.5	
QNILR1726	1 1/16	26mm x 1.5	
QNILR1727	1 1/16	27mm x 1.5	
QNILR1733	1 1/16	33mm x 1.5	
QNILR2126	1 5/16	26mm x 1.5	
QNILR2133	1 5/16	33mm x 1.5	
QNILR2142	1 5/16	42mm x 2	
QNILR2633	1 5/8	33mm x 1.5	
QNILR3048	1 7/8	48mm x 2	

JIC Male x NPT Male



Part Number	JIC M	NPT M	
QNILU0702	7/16	1/8	
QNILU0704	7/16	1/4	
QNILU0706	7/16	3/8	
QNILU0902	9/16	1/8	
QNILU0904	9/16	1/4	
QNILU0906	9/16	3/8	
QNILU0908	9/16	1/2	
QNILU0912	9/16	3/4	
QNILU12	3/4	3/4	
QNILU1204	3/4	1/4	
QNILU1206	3/4	3/8	
QNILU1208	3/4	1/2	
QNILU1216	3/4	1	
QNILU1408	7/8	1/2	
QNILU1708	1 1/16	1/2	
QNILU1712	1 1/16	3/4	
QNILU1716	1 1/16	1	
QNILU1720	1 1/16	1 1/4	
QNILU2112	1 5/16	3/4	
QNILU2116	1 5/16	1	
QNILU2120	1 5/16	1 1/4	
QNILU2124	1 5/16	1 1/2	
QNILU2616	1 5/8	1	
QNILU2620	1 5/8	1 1/4	
QNILU3020	1 7/8	1 1/4	
QNILU3024	1 7/8	1 1/2	
QNILU4024	2 1/2	1 1/2	
QNILU4032	2 1/2	2	

JIC Male x ORFS Male



Part Number	JIC M	ORFS M	
QNILW0709	7/16	9/16	
QNILW0911	9/16	11/16	
QNILW1213	3/4	13/16	
QNILW1413	7/8	13/16	
QNILW1416	7/8	1	
QNILW1719	1 1/16	1 3/16	
QNILW2123	1 5/16	1 7/16	
QNILW2627	1 5/8	1 11/16	

UNO Male x ORFS Male



Part Number	UNO M	ORFS M	
QNIPW0709	7/16	9/16	
QNIPW0909	9/16	9/16	
QNIPW0911	9/16	11/16	
QNIPW0913	9/16	13/16	
QNIPW1211	3/4	11/16	
QNIPW1213	3/4	13/16	
QNIPW1216	3/4	1	
QNIPW1413	7/8	13/16	
QNIPW1416	7/8	1	
QNIPW1419	7/8	1 3/16	
QNIPW1713	1 1/16	13/16	
QNIPW1716	1 1/16	1	
QNIPW1719	1 1/16	1 3/16	
QNIPW2119	1 5/16	1 3/16	
QNIPW2123	1 5/16	1 7/16	
QNIPW2127	1 5/16	1 11/16	
QNIPW2627	1 5/8	1 11/16	

Metric Male x ORFS Male



Part Number	Metric M	ORFS M	
QNIRW1209	12 x 1.5	9/16	
QNIRW1411	14 x 1.5	11/16	
QNIRW1611	16 x 1.5	11/16	
QNIRW1813	18 x 1.5	13/16	
QNIRW2213	22 x 1.5	13/16	
QNIRW2216	22 x 1.5	1	
QNIRW2719	27 x 2	1 3/16	
QNIRW3323	33 x 2	1 7/16	
QNIRW4223	42 x 2	1 7/16	

SAE Male



Part Number	SAE M	SAE M	
QNISM10	5/8	5/8	

SAE Male x BSPT Male



Part Number	SAE M	BSPT M	
QNISME1004	5/8	1/4	
QNISME1006	5/8	3/8	
QNISME1712	1 1/16	3/4	

SAE Male x NPT Male



Part Number	SAE M	NPT M	
QNISMU1006	5/8	3/8	

NPT Male



Part Number	NPT M	NPT M	
QNIU02	1/8	1/8	
QNIU04	1/4	1/4	
QNIU0402	1/4	1/8	
QNIU06	3/8	3/8	
QNIU0604	3/8	1/4	
QNIU08	1/2	1/2	
QNIU0804	1/2	1/4	
QNIU0806	1/2	3/8	
QNIU12	3/4	3/4	
QNIU1206	3/4	3/8	
QNIU1208	3/4	1/2	
QNIU16	1	1	
QNIU1608	1	1/2	
QNIU1612	1	3/4	
QNIU20	1 1/4	1 1/4	
QNIU2016	1 1/4	1	
QNIU24	1 1/2	1 1/2	
QNIU2420	1 1/2	1/4	
QNIU32	2	2	
QNIU3224	2	1 1/2	
QNIU48	3	3	

ORFS Male



Part Number	ORFS M	ORFS M	
QNIW09	9/16	9/16	
QNIW0911	9/16	11/16	
QNIW11	11/16	11/16	
QNIW1113	11/16	13/16	
QNIW13	13/16	13/16	
QNIW1316	13/16	1	
QNIW1319	13/16	1 3/16	
QNIW16	1	1	
QNIW1613	1	13/16	
QNIW1619	1	1 3/16	
QNIW19	1 3/16	1 3/16	
QNIW1923	1 3/16	1 7/16	
QNIW23	1 7/16	1 7/16	
QNIW27	1 11/16	1 11/16	

ADAPTORS (QNU) Nut

BSPF Female Nut



Part Number	BSPF F		
QNUA06	3/8		
QNUA08	1/2		

JIC Female Nut



Part Number	JIC F		
QNUK07	7/16		
QNUK09	9/16		
QNUK12	3/4		
QNUK14	7/8		
QNUK17	1 1/16		
QNUK21	1 5/16		

ADAPTORS (QP) Plug

BSPP Male



Part Number	BSPP M		
QPD02	1/8		
QPD04	1/4		
QPD06	3/8		
QPD08	1/2		
QPD12	3/4		
QPD16	1		
QPD20	1 1/4		
QPD24	1 1/2		
QPD32	2		

BSPP Male Allen Head (ED Seal)



Part Number	BSPP M		
QPD02A	1/8		
QPD04A	1/4		
QPD06A	3/8		
QPD08A	1/2		
QPD12A	3/4		
QPD16A	1		
QPD20A	1 1/4		
QPD24A	1 1/2		

BSPT Male



Part Number	BSPT M		
QPE02	1/8		
QPE04	1/4		
QPE06	3/8		
QPE08	1/2		
QPE12	3/4		
QPE16	1		
QPE20	1 1/4		
QPE24	1 1/2		
QPE32	2		

BSPT Male - Counter Sunk



Part Number	BSPT M		
QPE-02-CS	1/8		
QPE-04-CS	1/4		
QPE-06-CS	3/8		
QPE-12-CS	3/4		
QPE-16-CS	1		

JIS Imperial BSP Male (Mitsubishi)



Part Number	JIS (BSP)		
QPJ04	1/4		
QPJ06	3/8		
QPJ08	1/2		

JIC Male



Part Number	JIC M		
QPL07	7/16		
QPL08	1/2		
QPL09	9/16		
QPL12	3/4		
QPL14	7/8		
QPL17	1 1/16		
QPL19	1 3/16		
QPL21	1 5/16		
QPL26	1 5/8		
QPL30	1 7/8		
QPL40	2 1/2		

JIS Metric Male (Komatsu)



Part Number	JIS (Metric)		
QPN14	14mm		
QPN16	16mm		
QPN18	18mm		
QPN20	20mm		
QPN22	22mm		
QPN24	24mm		
QPN26	26mm		
QPN30	30mm		
QPN33	33mm		

UNO Male Hex



Part Number	UNO M		
QPP07	7/16		
QPP09	9/16		
QPP12	3/4		
QPP14	7/8		
QPP17	1 1/16		
QPP21	1 5/16		
QPP26	1 5/8		

UNO Male Allen Head



Part Number	UNO M		
QPP05A	5/16		
QPP06A	3/8		
QPP07A	7/16		
QPP08A	1/2		
QPP09A	9/16		
QPP12A	3/4		
QPP14A	7/8		
QPP17A	1 1/16		
QPP21A	1 5/16		
QPP26A	1 5/8		

Metric Male Port Plug

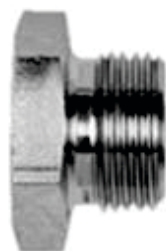

Part Number	Metric M		
QPR1215	12mm x 1.5		
QPR1415	14mm x 1.5		
QPR1615	16mm x 1.5		
QPR1815	18mm x 1.5		
QPR2015	20mm x 1.5		
QPR2215	22mm x 1.5		
QPR2415	24mm x 1.5		
QPR2615	26mm x 1.5		
QPR3015	30mm x 1.5		
QPR3020	30mm x 2		
QPR3315	33mm x 1.5		
QPR3320	33mm x 2		
QPR3615	36mm x 1.5		
QPR3620	36mm x 2		
QPR4220	42mm x 2		
QPR4520	45mm x 2		
QPR5220	52mm x 2		

NPT Male



Part Number	NPT M		
QPU02	1/8		
QPU04	1/4		
QPU06	3/8		
QPU08	1/2		
QPU12	3/4		
QPU16	1		
QPU20	1 1/4		
QPU24	1 1/2		
QPU32	2		

NPT Male - Counter Sunk



Part Number	NPT M		
QPU-02-CS	1/8		
QPU-04-CS	1/4		
QPU-06-CS	3/8		
QPU-08-CS	1/2		
QPU-12-CS	3/4		
QPU-16-CS	1		

ORFS Male



Part Number	ORFS M		
QPW09	9/16		
QPW11	11/16		
QPW13	13/16		
QPW16	1		
QPW19	1 3/16		
QPW23	1 7/16		
QPW27	1 11/16		
QPW32	2		

ADAPTORS (QR) Reducing Bush

BSPP Female x BSPP Male



Part Number	BSPP F	BSPP M	
QRASD0406	1/4	3/8	
QRASD0408	1/4	1/2	
QRASD0608	3/8	1/2	
QRASD0612	3/8	3/4	
QRASD0812	1/2	3/4	
QRASD0816	1/2	1	
QRASD1216	3/4	1	
QRASD1220	3/4	1 1/4	
QRASD1232	3/4	2	
QRASD1620	1	1 1/4	
QRASD1624	1	1 1/2	
QRASD2024	1 1/4	1 1/2	
QRASD2032	1 1/4	2	
QRASD2432	1 1/2	2	

BSPT Female x BSPT Male



Part Number	BSPT F	BSPT M	
QRBE0204	1/8	1/4	
QRBE0206	1/8	3/8	
QRBE0208	1/8	1/2	
QRBE0406	1/4	3/8	
QRBE0408	1/4	1/2	
QRBE0412	1/4	3/4	
QRBE0416	1/4	1	
QRBE0608	3/8	1/2	
QRBE0612	3/8	3/4	
QRBE0616	3/8	1	
QRBE0812	1/2	3/4	
QRBE0816	1/2	1	
QRBE0820	1/2	1 1/4	
QRBE1216	3/4	1	
QRBE1220	3/4	1 1/4	
QRBE1224	3/4	1 1/2	
QRBE1620	1	1 1/4	
QRBE1624	1	1 1/2	
QRBE1632	1	2	
QRBE2024	1 1/4	1 1/2	
QRBE2032	1 1/4	2	
QRBE2432	1 1/2	2	

JIC Female x JIC Male



Part Number	JIC F	JIC M	
QRKL0807	1/2	7/16	
QRKL0907	9/16	7/16	
QRKL1207	3/4	7/16	
QRKL1209	3/4	9/16	
QRKL1407	7/8	7/16	
QRKL1409	7/8	9/16	
QRKL1412	7/8	3/4	
QRKL1707	1 1/16	7/16	
QRKL1709	1 1/16	9/16	
QRKL1712	1 1/16	3/4	
QRKL1714	1 1/16	7/8	
QRKL2109	1 5/16	9/16	
QRKL2112	1 5/16	3/4	
QRKL2114	1 5/16	7/8	
QRKL2117	1 5/16	1 1/16	
QRKL2612	1 5/8	3/4	
QRKL2617	1 5/8	1 1/16	
QRKL2621	1 5/8	1 5/16	
QRKL3021	1 7/8	1 5/16	
QRKL3026	1 7/8	1 5/8	
QRKL4030	2 1/2	1 7/8	

NPT Female x NPT Male



Part Number	NPT F	NPT M	
QRTU0204	1/8	1/4	
QRTU0206	1/8	3/8	
QRTU0208	1/8	1/2	
QRTU0212	1/8	3/4	
QRTU0406	1/4	3/8	
QRTU0408	1/4	1/2	
QRTU0412	1/4	3/4	
QRTU0416	1/4	1	
QRTU0420	1/4	1 1/4	
QRTU0608	3/8	1/2	
QRTU0612	3/8	3/4	
QRTU0616	3/8	1	
QRTU0812	1/2	3/4	
QRTU0816	1/2	1	
QRTU1216	3/4	1	
QRTU1220	3/4	1 1/4	
QRTU1224	3/4	1 1/2	
QRTU1620	1	1 1/4	
QRTU1624	1	1 1/2	
QRTU1632	1	2	
QRTU2024	1 1/4	1 1/2	
QRTU2032	1 1/4	2	
QRTU2432	1 1/2	2	

ORFS Female x ORFS Male



Part Number	ORFS F	ORFS M	
QRVW1109	11/16	9/16	
QRVW1309	13/16	9/16	
QRVW1311	13/16	11/16	
QRVW1609	1	9/16	
QRVW1611	1	11/16	
QRVW1613	1	13/16	
QRVW1911	1 3/16	11/16	
QRVW1913	1 3/16	13/16	
QRVW1916	1 3/16	1	
QRVW2316	1 7/16	1	
QRVW2319	1 7/16	1 3/16	
QRVW2719	1 11/16	1 3/16	
QRVW2723	1 11/16	1 7/16	

ADAPTORS (QS) Socket

BSPP Female



Part Number	BSPP F	BSPP F	
QSA04	1/4	1/4	
QSA06	3/8	3/8	
QSA08	1/2	1/2	
QSA12	3/4	3/4	
QSA16	1	1	
QSA24	1 1/2	1 1/2	
QSA32	2	2	

BSPT Male



Part Number	BSPT F	BSPT F	
QSB02	1/8	1/8	
QSB04	1/4	1/4	
QSB0402	1/4	1/8	
QSB06	3/8	3/8	
QSB0604	3/8	1/4	
QSB08	1/2	1/2	
QSB0804	1/2	1/4	
QSB0806	1/2	3/8	
QSB12	3/4	3/4	
QSB1204	3/4	1/4	
QSB1208	3/4	1/2	
QSB16	1	1	
QSB1612	1	3/4	
QSB20	1 1/4	1 1/4	
QSB2016	1 1/4	1	
QSB24	1 1/2	1 1/2	
QSB32	2	2	
QSB32-BS	2	2	Black Steel

UNO Female



Part Number	UNO F	UNO F	
QSPF07	7/16	7/16	
QSPF09	9/16	9/16	
QSPF12	3/4	3/4	
QSPF14	7/8	7/8	
QSPF17	1 1/16	1 1/16	
QSPF21	1 5/16	1 5/16	

NPT Female



Part Number	NPT F	NPT F	
QST02	1/8	1/8	
QST04	1/4	1/4	
QST0402	1/4	1/8	
QST06	3/8	3/8	
QST0604	3/8	1/4	
QST08	1/2	1/2	
QST12	3/4	3/4	
QST16	1	1	
QST1612	1	3/4	
QST20	1 1/4	1 1/4	
QST24	1 1/2	1 1/2	
QST32	2	2	
QST48	3	3	

ADAPTORS (QTE) Tee Piece

BSPP Female Swivel x BSPT Male x BSPT Female - Run Tee

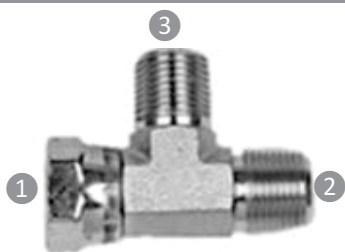

Part Number	① BSPT F	② BSPT M	③ BSPT M
QTEAEE04	1/4	1/4	1/4
QTEAEE06	3/8	3/8	3/8
QTEAEE08	1/2	1/2	1/2
QTEAEE12	3/4	3/4	3/4
QTEAEE16	1	1	1
QTEAEE20	1 1/4	1 1/4	1 1/4

BSPP Female Solid



Part Number	① BSPP F	② BSPP F	③ BSPP F
QTEAS04	1/4	1/4	1/4
QTEAS16	1	1	1
QTEAS32	2	2	2

BSPP Female x BSPP Male x BSPP Male - Run Tee



Part Number	① BSPP F	② BSPP M	③ BSPP M
QTEASDD04	1/4	1/4	1/4
QTEASDD06	3/8	3/8	3/8
QTEASDD08	1/2	1/2	1/2
QTEASDD12	3/4	3/4	3/4

BSPT Male x BSPT Female x BSPT Taper Female - Run Tee

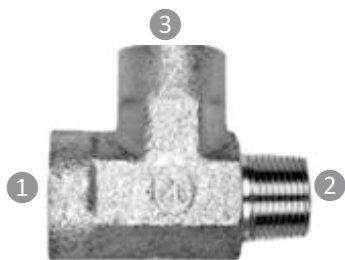

Part Number	① BSPT F	② BSPT M	③ BSPT F
QTEBBSE02	1/8	1/8	1/8
QTEBBSE04	1/4	1/4	1/4
QTEBBSE06	3/8	3/8	3/8
QTEBBSE08	1/2	1/2	1/2
QTEBBSE12	3/4	3/4	3/4
QTEBBSE16	1	1	1
QTEBBSE20	1 1/4	1 1/4	1 1/4

JIC Male Bulkhead x JIC Male x JIC Male - Run Tee

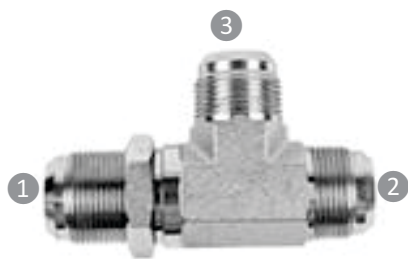

Part Number	① JIC M B/H	② JIC M	③ JIC M
QTEBLLL09	9/16	9/16	9/16
QTEBLLL12	3/4	3/4	3/4
QTEBLLL14	7/8	7/8	7/8
QTEBLLL17	1 1/16	1 1/16	1 1/16
QTEBLLL21	1 5/16	1 5/16	1 5/16
QTEBLLL26	1 5/8	1 5/8	1 5/8
QTEBLLL30	1 7/8	1 7/8	1 7/8

BSPT Female

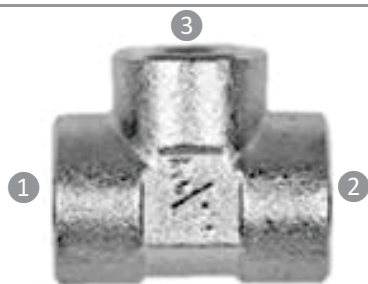

Part Number	① BSPT F	② BSPT F	③ BSPT F
QTEBS02	1/8	1/8	1/8
QTEBS04	1/4	1/4	1/4
QTEBS06	3/8	3/8	3/8
QTEBS08	1/2	1/2	1/2
QTEBS12	3/4	3/4	3/4
QTEBS16	1	1	1
QTEBS20	1 1/4	1 1/4	1 1/4
QTEBS24	1 1/2	1 1/2	1 1/2
QTEBS32	2	2	2

BSPP Male x BSPT Male x BSPT Male - Run Tee

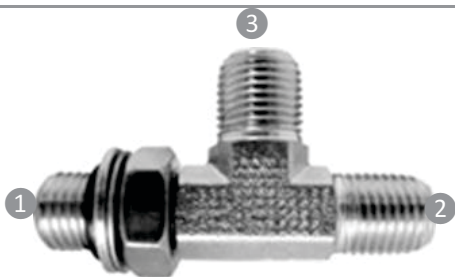

Part Number	① BSPP M	② BSPT M	③ BSPT M
QTEDEE04	1/4	1/4	1/4
QTEDEE08	1/2	1/2	1/2

BSPP Male x JIC Male x JIC Male - Run Tee

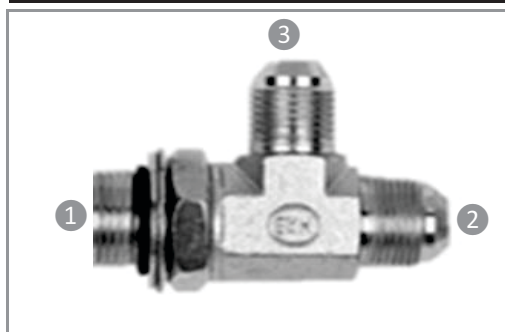

Part Number	① BSPP M	② JIC M	③ JIC M
QTEDLL040707	1/4	7/16	7/16
QTEDLL040909	1/4	9/16	9/16
QTEDLL060909	3/8	9/16	9/16
QTEDLL061212	3/8	3/4	3/4
QTEDLL081212	1/2	3/4	3/4
QTEDLL081414	1/2	7/8	7/8
QTEDLL121717	3/4	1 1/16	1 1/6
QTEDLL162121	1	1 5/16	1 5/16

BSPT Male

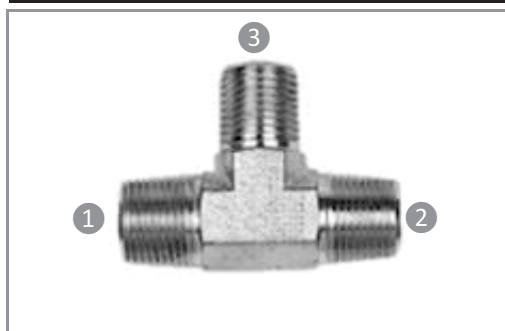

Part Number	① BSPT M	② BSPT M	③ BSPT M
QTEE02	1/8	1/8	1/8
QTEE04	1/4	1/4	1/4
QTEE06	3/8	3/8	3/8
QTEE08	1/2	1/2	1/2
QTEE12	3/4	3/4	3/4
QTEE16	1	1	1
QTEE20	1 1/4	1 1/4	1 1/4

BSPT Male x JIC Male x JIC Male - Run Tee



Part Number	① BSPT M	② JIC M	③ JIC M
QTEELL020707	1/8	7/16	7/16
QTEELL040707	1/4	7/16	7/16
QTEELL040909	1/4	9/16	9/16
QTEELL060909	3/8	9/16	9/16
QTEELL061212	3/8	3/4	3/4
QTEELL081212	1/2	3/4	3/4
QTEELL081414	1/2	7/8	7/8
QTEELL121717	3/4	1 1/16	1 1/16
QTEELL162121	1	1 5/16	1 5/16

JIC Female Swivel x JIC Male x JIC Male - Run Tee

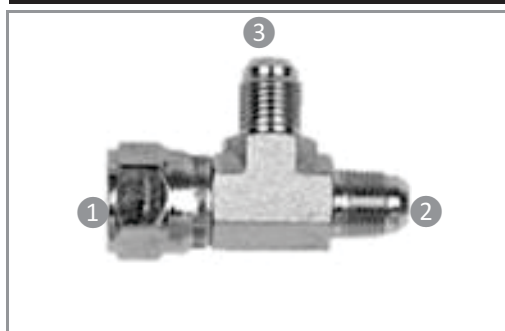

Part Number	① JIC F	② JIC M	③ JIC M
QTEKLL07	7/16	7/16	7/16
QTEKLL08	1/2	1/2	1/2
QTEKLL09	9/16	9/16	9/16
QTEKLL12	3/4	3/4	3/4
QTEKLL120909	3/4	9/16	9/16
QTEKLL121209	3/4	3/4	9/16
QTEKLL14	7/8	7/8	7/8
QTEKLL141409	7/8	7/8	9/16
QTEKLL141412	7/8	7/8	3/4
QTEKLL17	1 1/16	1 1/16	1 1/16
QTEKLL171414	1 1/16	7/8	7/8
QTEKLL171714	1 1/16	1 1/16	7/8

Continued on the following page

JIC Female Swivel x JIC Male x JIC Male - Run Tee Continued...

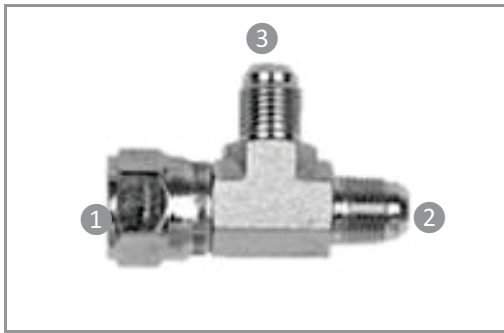

Part Number	① JIC F	② JIC M	③ JIC M
QTEKLL21	1 5/16	1 5/16	1 5/16
QTEKLL211717	1 5/16	1 1/16	1 1/16
QTEKLL212117	1 5/16	1 5/16	1 1/16
QTEKLL26	1 5/8	1 5/8	1 5/8
QTEKLL30	1 7/8	1 7/8	1 7/8
QTEKLL40	2 1/2	2 1/2	2 1/2

JIC Male x JIC Male x JIC Male Tee

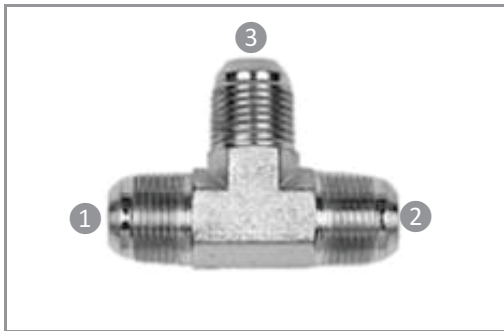

Part Number	① JIC M	② JIC M	③ JIC M
QTEL07	7/16	7/16	7/16
QTEL09	9/16	9/16	9/16
QTEL090912	9/16	9/16	3/4
QTEL12	3/4	3/4	3/4
QTEL121209	3/4	3/4	9/16
QTEL121214	3/4	3/4	7/8
QTEL14	7/8	7/8	7/8
QTEL17	1 1/16	1 1/16	1 1/16
QTEL21	1 5/16	1 5/16	1 5/16
QTEL212117	1 5/16	1 5/16	1 1/16
QTEL26	1 5/8	1 5/8	1 5/8
QTEL30	1 7/8	1 7/8	1 7/8
QTEL40	2 1/2	2 1/2	2 1/2

JIC Male x JIC Male x BSPP Male - Branch Tee



Part Number	① JIC M	② JIC M	③ BSPP M
QTELLD070704	7/16	7/16	1/4
QTELLD090904	9/16	9/16	1/4
QTELLD090906	9/16	9/16	3/8
QTELLD121208	3/4	3/4	1/2
QTELLD141408	7/8	7/8	1/2
QTELLD171712	1 1/16	1 1/16	3/4
QTELLD212116	1 5/16	1 5/16	1

JIC Male x JIC Male x BSPT Male - Branch Tee



Part Number	① JIC M	② JIC M	③ BSPT M
QTELLE070702	7/16	7/16	1/8
QTELLE090904	9/16	9/16	1/4
QTELLE090906	9/16	9/16	3/8
QTELLE121206	3/4	3/4	3/8
QTELLE121208	3/4	3/4	1/2
QTELLE141408	7/8	7/8	1/2
QTELLE171712	1 1/16	1 1/16	3/4
QTELLE212116	1 5/16	1 5/16	1

JIC Male x JIC Male x JIC Female - Branch Tee

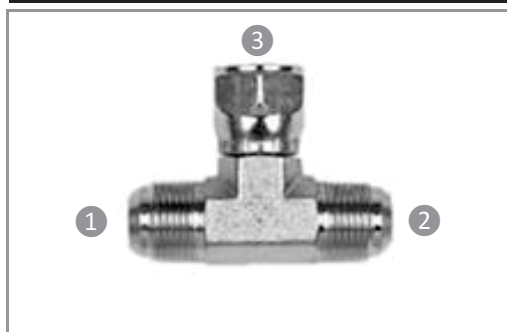

Part Number	① JIC M	② JIC M	③ JIC F
QTELLK07	7/16	7/16	7/16
QTELLK08	1/2	1/2	1/2
QTELLK09	9/16	9/16	9/16
QTELLK12	3/4	3/4	3/4
QTELLK14	7/8	7/8	7/8
QTELLK17	1 1/16	1 1/16	1 1/16
QTELLK21	1 5/16	1 5/16	1 5/16
QTELLK26	1 5/8	1 5/8	1 5/8
QTELLK30	1 7/8	1 7/8	1 7/8

JIC Male x JIC Male x JIC Male Bulkhead - Branch Tee



Part Number	① JIC M	② JIC M	③ JIC M B/H
QTELLLB09	9/16	9/16	9/16
QTELLLB12	3/4	3/4	3/4
QTELLLB14	7/8	7/8	7/8
QTELLLB17	1 1/16	1 1/16	1 1/16
QTELLLB21	1 5/16	1 5/16	1 5/16

JIC Male x JIC Male x UNO Male - Branch Tee



Part Number	① JIC M	② JIC M	③ UNO M
QTELLP07	7/16	7/16	7/16
QTELLP09	9/16	9/16	9/16
QTELLP12	3/4	3/4	3/4
QTELLP14	7/8	7/8	7/8
QTELLP17	1 1/16	1 1/16	1 1/16
QTELLP21	1 5/16	1 5/16	1 5/16

JIC Male x JIC Male x NPT Male - Branch Tee



Part Number	① JIC M	② JIC M	③ NPT M
QTELLU070702	7/16	7/16	1/8
QTELLU090904	9/16	9/16	1/4
QTELLU121206	3/4	3/4	3/8

JIC Male x UNO Male x JIC Male - Run Tee

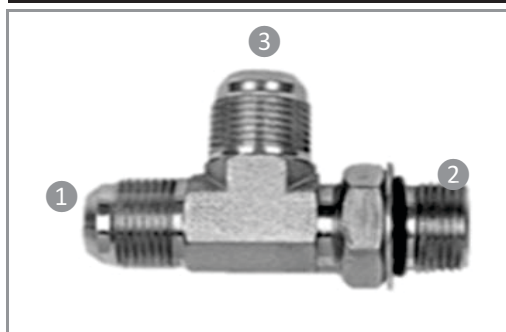

Part Number	① JIC M	② UNO M	③ JIC M
QTELPL07	7/16	7/16	7/16
QTELPL09	9/16	9/16	9/16
QTELPL12	3/4	3/4	3/4
QTELPL121412	3/4	7/8	3/4
QTELPL14	7/8	7/8	7/8
QTELPL17	1 1/16	1 1/16	1 1/16
QTELPL172117	1 1/16	1 5/16	1 1/16
QTELPL21	1 5/16	1 5/16	1 5/16
QTELPL26	1 5/8	1 5/8	1 5/8

Komatsu JIS Female Swivel x JIS Male x JIS Male - Metric

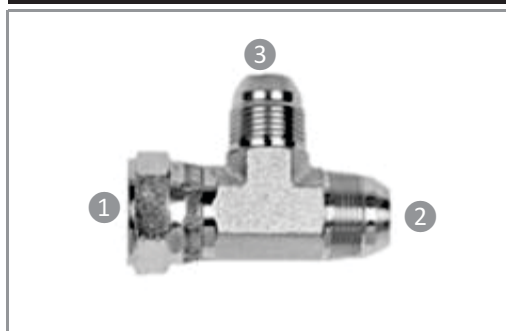

Part Number	① JIS F	② JIS M	③ JIS M
QTEMNN14	14mm x 1.5	14mm x 1.5	14mm x 1.5
QTEMNN18	18mm x 1.5	18mm x 1.5	18mm x 1.5
QTEMNN22	22mm x 1.5	22mm x 1.5	22mm x 1.5
QTEMNN24	24mm x 1.5	24mm x 1.5	24mm x 1.5
QTEMNN30	30mm x 1.5	30mm x 1.5	30mm x 1.5

NPT Female - Solid

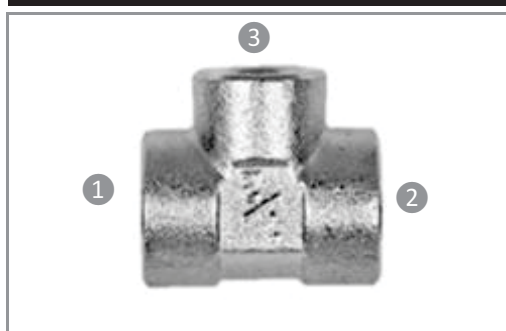

Part Number	① NPT F	② NPT F	③ NPT F
QTETS02	1/8	1/8	1/8
QTETS04	1/4	1/4	1/4
QTETS06	3/8	3/8	3/8
QTETS08	1/2	1/2	1/2
QTETS12	3/4	3/4	3/4
QTETS16	1	1	1
QTETS20	1 1/4	1 1/4	1 1/4
QTETS24	1 1/2	1 1/2	1 1/2
QTETS32	2	2	2

NPT Female x NPT Female x NPT Male - Branch Tee

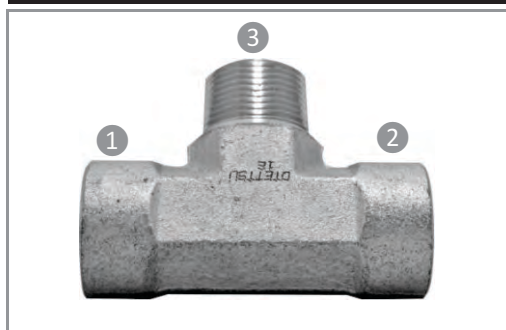

Part Number	① NPT F	② NPT F	③ NPT M
QTETTSU16	1	1	1

NPT Male x NPT Female x NPT Female - Run Tee

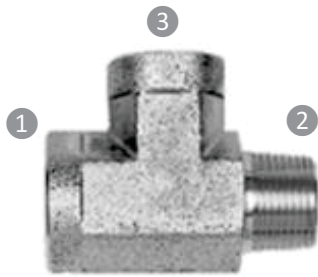

Part Number	① NPT F	② NPT M	③ NPT F
QTETUTS04	1/4	1/4	1/4
QTETUTS06	3/8	3/8	3/8
QTETUTS08	1/2	1/2	1/2
QTETUTS12	3/4	3/4	3/4
QTETUTS16	1	1	1

NPT Male

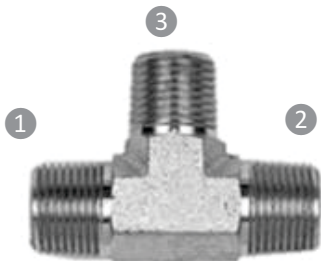

Part Number	① NPT M	② NPT M	③ NPT M
QTEU02	1/8	1/8	1/8
QTEU04	1/4	1/4	1/4
QTEU06	3/8	3/8	3/8
QTEU08	1/2	1/2	1/2
QTEU12	3/4	3/4	3/4
QTEU16	1	1	1

NPT Male x JIC Male x JIC Male -Run Tee



PICTURE NOT AVAILABLE

Part Number	① NPT M	② JIC M	③ JIC M
QTEULL262026	1 5/8	1 1/4	1 5/8

NPT Male x NPT Male x NPT Female - Branch Tee



Part Number	① NPT M	② NPT M	③ NPT F
QTEUUTS20	1 1/4	1 1/4	1 1/4

ORFS Female x ORFS Male x ORFS Male - Run Tee

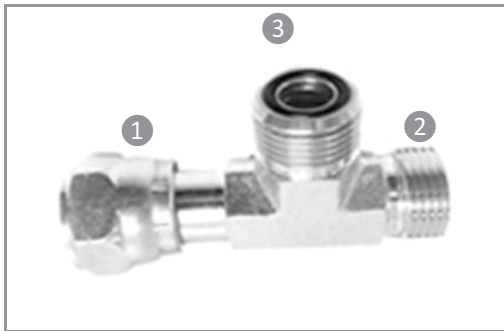

Part Number	1 ORFS F	2 ORFS M	3 ORFS M
QTEVWW09	9/16	9/16	9/16
QTEVWW11	11/16	11/16	11/16
QTEVWW13	13/16	13/16	13/16
QTEVWW16	1	1	1
QTEVWW19	1 3/16	1 3/16	1 3/16
QTEVWW23	1 7/16	1 7/16	1 7/16
QTEVWW27	1 11/16	1 11/16	1 11/16

ORFS Male

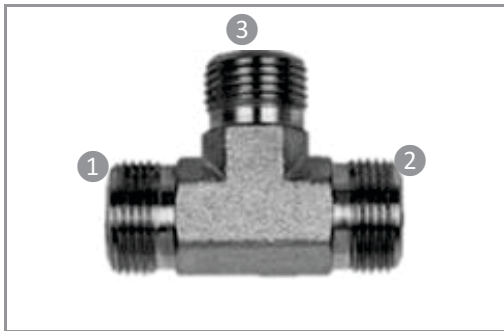

Part Number	1 ORFS M	2 ORFS M	3 ORFS M
QTEW09	9/16	9/16	9/16
QTEW11	11/16	11/16	11/16
QTEW13	13/16	13/16	13/16
QTEW16	1	1	1
QTEW19	1 3/16	1 3/16	1 3/16
QTEW23	1 7/16	1 7/16	1 7/16

ORFS Male x ORFS Male x ORFS Female - Branch Tee



Part Number	1 ORFS M	2 ORFS M	3 ORFS F
QTEWWV09	9/16	9/16	9/16
QTEWWV11	11/16	11/16	11/16
QTEWWV13	13/16	13/16	13/16
QTEWWV16	1	1	1
QTEWWV19	1 3/16	1 3/16	1 3/16
QTEWWV23	1 7/16	1 7/16	1 7/16

Low Pressure Hosetail x Low Pressure Hose Tail x BSPP Female - Branch Tee



Part Number	1 L/P Hosetail	2 L/P Hosetail	3 BSPP F
QTEXXA16	1	1	1

ADAPTORS (QTE) Tee Piece (Test Port Adaptors)

BSPF Female x BSPF Male x UNO Female (SAE O Ring)



Part Number	1 BSPF F	2 BSPF M	3 UNO F
QTEADPFS040407	1/4	1/4	7/16
QTEADPFS060607	3/8	3/8	7/16
QTEADPFS080807	1/2	1/2	7/16
QTEADPFS121207	3/4	3/4	7/16

JIC Female Swivel x JIC Male x UNO Female



Part Number	1 JIC F	2 JIC M	3 UNO F
QTEKLPFS07	7/16	7/16	7/16
QTEKLPFS090907	9/16	9/16	7/16
QTEKLPFS121207	3/4	3/4	7/16
QTEKLPFS141407	7/8	7/8	7/16
QTEKLPFS171707	1 1/16	1 1/16	7/16
QTEKLPFS212107	1 5/16	1 5/16	7/16
QTEKLPFS262607	1 5/8	1 5/8	7/16

UNO Female x ORFS Female x ORFS Male



Part Number	1 ORFS F	2 ORFS M	3 UNO F
QTEVWPFS070909	9/16	7/16	9/16
QTEVWPFS071111	11/16	7/16	11/16
QTEVWPFS071313	13/16	7/16	13/16
QTEVWPFS071616	1	7/16	1
QTEVWPFS071919	1 3/16	7/16	1 3/16

ADAPTORS (QTIA) Imperial Tube

JIC Tube Nut



Part Number	JIC Nut	Tube OD	
QTIA9K07	7/16	1/4	
QTIA9K09	9/16	3/8	
QTIA9K12	3/4	1/2	
QTIA9K14	7/8	5/8	
QTIA9K17	1 1/16	3/4	
QTIA9K21	1 5/16	1	
QTIA9K26	1 5/8	1 1/4	
QTIA9K30	1 7/8	1 1/2	

JIC Tube Sleeve



Part Number	JIC Nut	Tube OD	
QTIA10K07	7/16	1/4	
QTIA10K09	9/16	3/8	
QTIA10K12	3/4	1/2	
QTIA10K14	7/8	5/8	
QTIA10K17	1 1/16	3/4	
QTIA10K21	1 5/16	1	
QTIA10K26	1 5/8	1 1/4	
QTIA10K30	1 7/8	1 1/2	

ADAPTORS (QTMA) Metric Tube

Metric Tube Joiner



Part Number	DIN	Tube OD	Thread Size
QTMA-04LL	LL	4mm	8mm x 1
QTMA-06L	L	6mm	12mm x 1.5
QTMA-06LL	LL	6mm	10mm x 1
QTMA-06S	S	6mm	14mm x 1.5
QTMA-08L	L	8mm	14mm x 1.5
QTMA-08S	S	8mm	16mm x 1.5
QTMA-10L	L	10mm	16mm x 1.5
QTMA-10S	S	10mm	18mm x 1.5
QTMA-12L	L	12mm	18mm x 1.5
QTMA-12S	S	12mm	20mm x 1.5
QTMA-14S	S	14mm	22mm x 1.5
QTMA-15L	L	15mm	22mm x 1.5
QTMA-16S	S	16mm	24mm x 1.5
QTMA-18L	L	18mm	26mm x 1.5
QTMA-20S	S	20mm	30mm x 2
QTMA-22L	L	22mm	30mm x 2
QTMA-25S	S	25mm	36mm x 2
QTMA-28L	L	28mm	36mm x 2
QTMA-30S	S	30mm	42mm x 2

Continued on the following page

Can't find what you're looking for? Contact us -



1300 654 782



07 5428 1311

All part numbers displayed in **BOLD ITALICS** are new items that may not be in stock as yet, please contact us for further details.

Metric Tube Joiner Continued...



Part Number	DIN	Tube OD	Thread Size
QTMA-35L	L	35mm	42mm x 2
QTMA-38S	S	38mm	52mm x 2
QTMA-42L	L	42mm	52mm x 2

Metric Tube Elbow



Part Number	DIN	Tube OD	Thread Size
QTMA1-06L	L	6mm	12mm x 1.5
QTMA1-06S	S	6mm	14mm x 1.5
QTMA1-08L	L	8mm	14mm x 1.5
QTMA1-08S	S	8mm	16mm x 1.5
QTMA1-10L	L	10mm	16mm x 1.5
QTMA1-10S	S	10mm	18mm x 1.5
QTMA1-12L	L	12mm	18mm x 1.5
QTMA1-12S	S	12mm	20mm x 1.5
QTMA1-14S	S	14mm	22mm x 1.5
QTMA1-15L	L	15mm	22mm x 1.5
QTMA1-16S	S	16mm	24mm x 1.5
QTMA1-18L	L	18mm	26mm x 1.5
QTMA1-20S	S	20mm	26mm x 1.5
QTMA1-22L	L	22mm	30mm x 2
QTMA1-25S	S	25mm	36mm x 2
QTMA1-28L	L	28mm	36mm x 2
QTMA1-30S	S	30mm	42mm x 2
QTMA1-35L	L	35mm	42mm x 2
QTMA1-38S	S	38mm	52mm x 2
QTMA1-42L	L	42mm	52mm x 2

Metric Female Swivel x Metric Tube - 90°

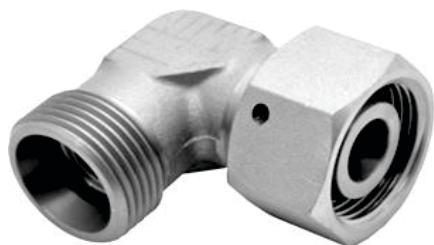

Part Number	DIN	Tube OD	Thread Size
QTMA2-06L	L	6mm	12mm x 1.5
QTMA2-06S	S	6mm	14mm x 1.5
QTMA2-08L	L	8mm	14mm x 1.5
QTMA2-08S	S	8mm	16mm x 1.5
QTMA2-10L	L	10mm	16mm x 1.5
QTMA2-10S	S	10mm	18mm x 1.5
QTMA2-12L	L	12mm	18mm x 1.5
QTMA2-12S	S	12mm	20mm x 1.5
QTMA2-14S	S	14mm	22mm x 1.5
QTMA2-15L	L	15mm	22mm x 1.5
QTMA2-16S	S	16mm	24mm x 1.5
QTMA2-18L	L	18mm	26mm x 1.5

Continued on the following page

Metric Female Swivel x Metric Tube - 90° Continued...

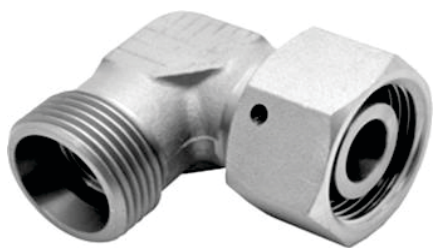

Part Number	DIN	Tube OD	Thread Size
QTMA2-20S	S	20mm	30mm x 2
QTMA2-22L	L	22mm	30mm x 2
QTMA2-25S	S	25mm	36mm x 2
QTMA2-28L	L	28mm	36mm x 2
QTMA2-30S	S	30mm	42mm x 2
QTMA2-35L	L	35mm	42mm x 2
QTMA2-38S	S	38mm	52mm x 2
QTMA2-42L	L	42mm	52mm x 2

Female Swivel x Male x Male

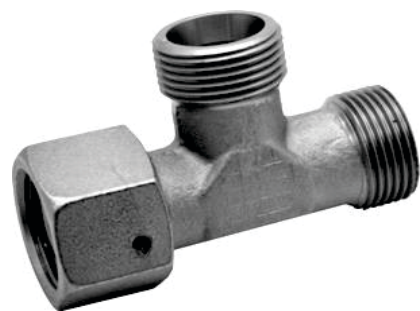

Part Number	DIN	Tube OD	Thread Size
QTMA3-06L	L	6mm	12mm x 1.5
QTMA3-06S	S	6mm	14mm x 1.5
QTMA3-08L	L	8mm	14mm x 1.5
QTMA3-08S	S	8mm	16mm x 1.5
QTMA3-10L	L	10mm	16mm x 1.5
QTMA3-10S	S	10mm	18mm x 1.5
QTMA3-12L	L	12mm	18mm x 1.5
QTMA3-12S	S	12mm	20mm x 1.5
QTMA3-14S	S	14mm	22mm x 1.5
QTMA3-15L	L	15mm	22mm x 1.5
QTMA3-16S	S	16mm	24mm x 1.5
QTMA3-18L	L	18mm	26mm x 1.5
QTMA3-20S	S	20mm	30mm x 2
QTMA3-22L	L	22mm	30mm x 2
QTMA3-25S	S	25mm	36mm x 2
QTMA3-28L	L	28mm	36mm x 2
QTMA3-30S	S	30mm	42mm x 2
QTMA3-35L	L	35mm	42mm x 2
QTMA3-38S	S	38mm	52mm x 2
QTMA3-42L	L	42mm	52mm x 2

Metric Branch Tee M x M x F Swivel

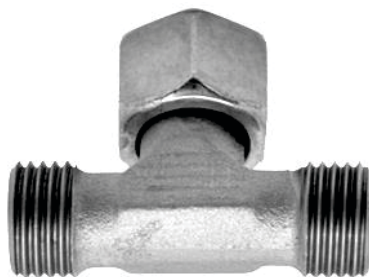

Part Number	DIN	Tube OD	Thread Size
QTMA4-06L	L	6mm	12mm x 1.5
QTMA4-06S	S	6mm	14mm x 1.5
QTMA4-08L	L	8mm	14mm x 1.5
QTMA4-08S	S	8mm	16mm x 1.5
QTMA4-10L	L	10mm	16mm x 1.5
QTMA4-10S	S	10mm	18mm x 1.5
QTMA4-12L	L	12mm	18mm x 1.5
QTMA4-12S	S	12mm	20mm x 1.5
QTMA4-14S	S	14mm	22mm x 1.5
QTMA4-15L	L	15mm	22mm x 1.5
QTMA4-16S	S	16mm	24mm x 1.5

Continued on the following page

Metric Branch Tee M x M x F Swivel Continued...

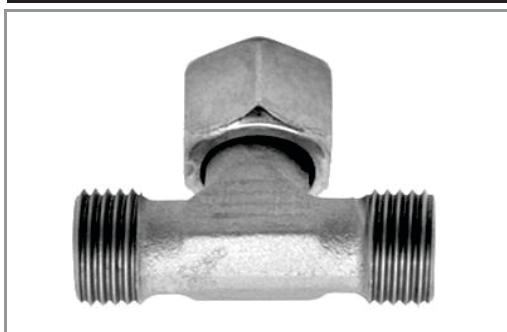

Part Number	DIN	Tube OD	Thread Size
QTMA4-18L	L	18mm	26mm x 1.5
QTMA4-20S	S	20mm	30mm x 2
QTMA4-22L	L	22mm	30mm x 2
QTMA4-25S	S	25mm	36mm x 2
QTMA4-28L	L	28mm	36mm x 2
QTMA4-30S	S	30mm	42mm x 2
QTMA4-35L	L	35mm	42mm x 2
QTMA4-38S	S	38mm	52mm x 2
QTMA4-42L	L	42mm	52mm x 2

Metric Tube Blanking Cap

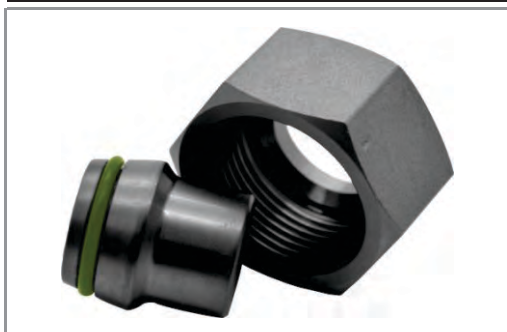

QTMA6 *ONLY* comes complete with Nut

Part Number	DIN	Tube Size	Thread Size
QTMA6-06L	L	6mm	12mm x 1.5
QTMA6-06S	S	6mm	14mm x 1.5
QTMA6-08L	L	8mm	14mm x 1.5
QTMA6-08S	S	8mm	16mm x 1.5
QTMA6-10L	L	10mm	16mm x 1.5
QTMA6-10S	S	10mm	18mm x 1.5
QTMA6-12L	L	12mm	18mm x 1.5
QTMA6-12S	S	12mm	20mm x 1.5
QTMA6-14S	S	14mm	22mm x 1.5
QTMA6-15L	L	15mm	22mm x 1.5
QTMA6-16S	S	16mm	24mm x 1.5
QTMA6-18L	L	18mm	26mm x 1.5
QTMA6-20S	S	20mm	30mm x 2
QTMA6-22L	L	22mm	30mm x 2
QTMA6-25S	S	25mm	36mm x 2
QTMA6-28L	L	28mm	36mm x 2
QTMA6-30S	S	30mm	42mm x 2
QTMA6-35L	L	35mm	42mm x 2
QTMA6-35S	S	35mm	42mm x 2
QTMA6-38S	S	38mm	52mm x 2
QTMA6-42L	L	42mm	52mm x 2

Metric Tube Nut



Part Number	DIN	Tube Size	Thread Size
QTMA7-06L	L	6mm	12mm x 1.5
QTMA7-06LL	LL	6mm	10mm x 1
QTMA7-06S	S	6mm	14mm x 1.5
QTMA7-08L	L	8mm	14mm x 1.5
QTMA7-08S	S	8mm	16mm x 1.5
QTMA7-10L	L	10mm	16mm x 1.5
QTMA7-10S	S	10mm	18mm x 1.5
QTMA7-12L	L	12mm	18mm x 1.5
QTMA7-12S	S	12mm	20mm x 1.5

Continued on the following page

Metric Tube Nut Continued...

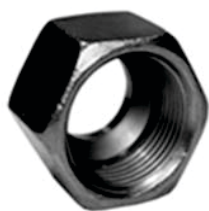

Part Number	DIN	Tube Size	Thread Size
QTMA7-14S	S	14mm	22mm x 1.5
QTMA7-15L	L	15mm	22mm x 1.5
QTMA7-16S	S	16mm	24mm x 1.5
QTMA7-18L	L	18mm	26mm x 1.5
QTMA7-20S	S	20mm	30mm x 2
QTMA7-22L	L	22mm	30mm x 2
QTMA7-25S	S	25mm	36mm x 2
QTMA7-28L	L	28mm	36mm x 2
QTMA7-30S	S	28mm	42mm x 2
QTMA7-35L	L	35mm	45mm x 2
QTMA7-38S	S	38mm	52mm x 2
QTMA7-42L	L	42mm	52mm x 2

Metric Tube Blanking Plug



Part Number	DIN	Tube OD	Thread Size
QTMA8-06L	L	6mm	12mm x 1.5
QTMA8-06S	S	6mm	14mm x 1.5
QTMA8-08L	L	8mm	14mm x 1.5
QTMA8-08S	S	8mm	16mm x 1.5
QTMA8-10L	L	10mm	16mm x 1.5
QTMA8-10S	S	10mm	18mm x 1.5
QTMA8-12L	L	12mm	18mm x 1.5
QTMA8-12S	S	12mm	20mm x 1.5
QTMA8-14S	S	14mm	22mm x 1.5
QTMA8-15L	L	15mm	22mm x 1.5
QTMA8-16S	S	16mm	24mm x 1.5
QTMA8-18L	L	18mm	26mm x 1.5
QTMA8-20S	S	20mm	30mm x 2
QTMA8-22L	L	22mm	30mm x 2
QTMA8-25S	S	25mm	36mm x 2
QTMA8-28L	L	28mm	36mm x 2
QTMA8-30S	S	30mm	42mm x 2
QTMA8-35L	L	35mm	
QTMA8-38S	S	38mm	52mm x 2
QTMA8-42L	L	42mm	52mm x 2

JIC Metric Tube Sleeve



Part Number	JIC Nut	Tube OD	
QTMA10K09	9/16	10mm	
QTMA10K12	3/4	12mm	
QTMA10K17	1 1/16	20mm	

For use with QTIA9K Nuts

Metric Cutting Ring



Part Number	DIN	Tube Size	
QTMA11-06LL	LL	6mm	
QTMA11-06LS	LS	6mm	
QTMA11-06S	S	6mm	
QTMA11-08LS	LS	8mm	
QTMA11-08S	S	8mm	
QTMA11-10LS	LS	10mm	
QTMA11-10S	S	10mm	
QTMA11-12LS	LS	12mm	
QTMA11-12S	S	12mm	
QTMA11-14S	S	14mm	
QTMA11-15L	L	15mm	
QTMA11-16S	S	16mm	
QTMA11-18L	L	18mm	
QTMA11-20S	S	20mm	
QTMA11-22L	L	22mm	
QTMA11-25S	S	25mm	
QTMA11-28L	L	28mm	
QTMA11-30S	S	30mm	
QTMA11-35L	L	35mm	
QTMA11-38S	S	38mm	
QTMA11-42L	L	42mm	

Metric Tube Tee



Part Number	DIN	Tube OD	Thread Size
QTMA12-06L	L	6mm	12mm x 1.5
QTMA12-06S	S	6mm	14mm x 1.5
QTMA12-08L	L	8mm	14mm x 1.5
QTMA12-08S	S	8mm	16mm x 1.5
QTMA12-10L	L	10mm	16mm x 1.5
QTMA12-10S	S	10mm	18mm x 1.5
QTMA12-12L	L	12mm	18mm x 1.5
QTMA12-12S	S	12mm	20mm x 1.5
QTMA12-14S	S	14mm	22mm x 1.5
QTMA12-15L	L	15mm	22mm x 1.5
QTMA12-16S	S	16mm	24mm x 1.5
QTMA12-18L	L	18mm	26mm x 1.5
QTMA12-20S	S	20mm	30mm x 2
QTMA12-22L	L	22mm	30mm x 2
QTMA12-25S	S	25mm	36mm x 2
QTMA12-28L	L	28mm	36mm x 2
QTMA12-30S	S	30mm	30mm x 2
QTMA12-35L	L	35mm	45mm x 2
QTMA12-38S	S	38mm	52mm x 2
QTMA12-42L	L	42mm	52mm x 2

Metric Bulkhead

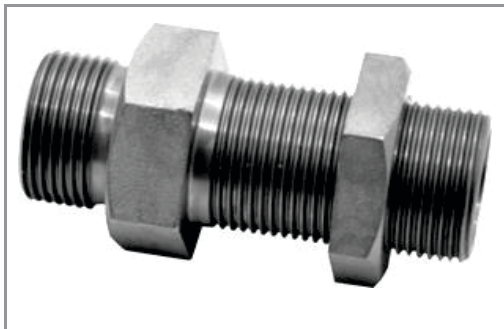

Part Number	DIN	Tube OD	Thread Size
QTMA15-06L	L	6mm	12mm x 1.5
QTMA15-06S	S	6mm	14mm x 1.5
QTMA15-08L	L	8mm	14mm x 1.5
QTMA15-08S	S	8mm	16mm x 1.5
QTMA15-10L	L	10mm	16mm x 1.5
QTMA15-10S	S	10mm	18mm x 1.5
QTMA15-12L	L	12mm	18mm x 1.5
QTMA15-12S	S	12mm	20mm x 1.5
QTMA15-14S	S	14mm	22mm x 1.5
QTMA15-15L	L	15mm	22mm x 1.5
QTMA15-16S	S	16mm	24mm x 1.5
QTMA15-18L	L	18mm	26mm x 1.5
QTMA15-20S	S	20mm	30mm x 2
QTMA15-22L	L	22mm	30mm x 2
QTMA15-25S	S	25mm	36mm x 2
QTMA15-28L	L	28mm	36mm x 2
QTMA15-30S	S	30mm	42mm x 2
QTMA15-35L	L	35mm	45mm x 2
QTMA15-38S	S	38mm	52mm x 2
QTMA15-42L	L	42mm	52mm x 2

Metric Tube x BSPT Male - 90°



Part Number	DIN	Tube OD	BSPT
QTMA1E-06LL02	LL	6mm	1/8
QTMA1E-06L02	L	6mm	1/8
QTMA1E-06L04	L	6mm	1/4
QTMA1E-06S04	S	6mm	1/4
QTMA1E-06S06	S	6mm	3/8
QTMA1E-08L02	L	8mm	1/8
QTMA1E-08L04	L	8mm	1/4
QTMA1E-08L06	L	8mm	3/8
QTMA1E-08S04	S	8mm	1/4
QTMA1E-08S06	S	8mm	3/8
QTMA1E-10L06	L	10mm	3/8
QTMA1E-10L04	L	10mm	1/4
QTMA1E-10S04	S	10mm	1/4
QTMA1E-10S06	S	10mm	3/8
QTMA1E-10S08	S	10mm	1/2
QTMA1E-12L04	L	12mm	1/4
QTMA1E-12L06	L	12mm	3/8
QTMA1E-12L08	L	12mm	1/2
QTMA1E-12S06	S	12mm	3/8
QTMA1E-12S08	S	12mm	1/2
QTMA1E-14S08	S	14mm	1/2
QTMA1E-15L08	L	15mm	1/2
QTMA1E-16S08	S	16mm	1/2
QTMA1E-18L08	L	18mm	1/2

Can't find what you're looking for? Contact us -



1300 654 782



07 5428 1311

All part numbers displayed in **BOLD ITALICS** are new items that may not be in stock as yet, please contact us for further details.

Metric Tube x BSPP Male - 90°

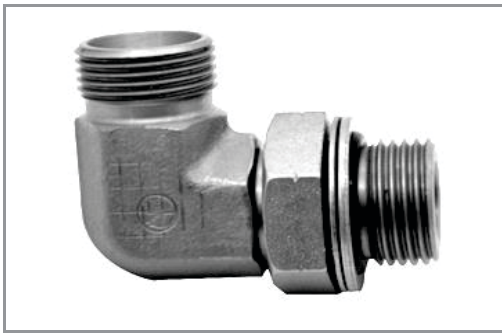

Part Number	DIN	Tube OD	BSPP
QTMA1D-06S04	S	6mm	1/4
QTMA1D-08L04	L	8mm	1/4
QTMA1D-08S04	S	8mm	1/4
QTMA1D-10L04	L	10mm	1/4
QTMA1D-10S06	S	10mm	3/8
QTMA1D-12L06	L	12mm	3/8
QTMA1D-12S06	S	12mm	3/8
QTMA1D-14S08	S	14mm	1/2
QTMA1D-15L08	L	15mm	1/2
QTMA1D-16S08	S	16mm	1/2
QTMA1D-18L08	L	18mm	1/2
QTMA1D-20S12	S	20mm	3/4
QTMA1D-22L12	L	22mm	3/4
QTMA1D-25S16	S	25mm	1
QTMA1D-28L16	L	28mm	1
QTMA1D-30S20	S	30mm	1 1/4
QTMA1D-35L20	L	35mm	1 1/4
QTMA1D-38S24	S	38mm	1 1/2
QTMA1D-42L24	L	42mm	1 1/2

Metric Tube x UNO (SAE Oring) Male - 90°



Part Number	DIN	Tube OD	UNO
QTMA1P-06L07	L	6mm	7/16
QTMA1P-06S07	S	6mm	7/16
QTMA1P-08L09	L	8mm	9/16
QTMA1P-08S09	S	8mm	9/16
QTMA1P-10L09	L	10mm	9/16
QTMA1P-10S09	S	10mm	9/16
QTMA1P-10S12	S	10mm	3/4
QTMA1P-12L12	L	12mm	3/4
QTMA1P-12S12	S	12mm	3/4
QTMA1P-14S14	S	14mm	7/8
QTMA1P-15L12	L	15mm	3/4
QTMA1P-15L14	L	15mm	7/8
QTMA1P-16S14	S	16mm	7/8
QTMA1P-18L17	L	18mm	1 1/16
QTMA1P-20S17	S	20mm	1 1/16
QTMA1P-22L17	L	22mm	1 1/16
QTMA1P-25S21	S	25mm	1 5/16
QTMA1P-28L17	L	28mm	1 1/16
QTMA1P-28L21	L	28mm	1 5/16
QTMA1P-30S26	S	30mm	1 5/8
QTMA1P-35L26	L	35mm	1 5/8
QTMA1P-38S30	S	38mm	1 7/8
QTMA1P-42L30	L	42mm	1 7/8

Metric Tube x BSPP Male

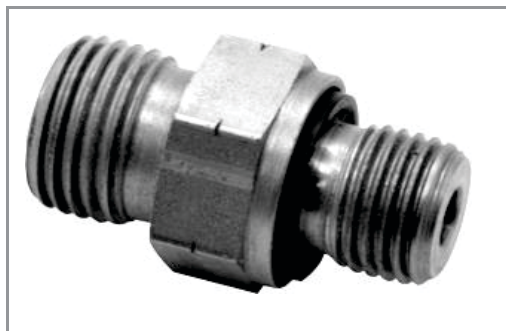

Including ED Seal

Part Number	DIN	Tube OD	Thread Size
QTMAD-06L02	L	6mm	1/8
QTMAD-06L04	L	6mm	1/4
QTMAD-06S04	S	6mm	1/4
QTMAD-08L02	L	8mm	1/8
QTMAD-08L04	L	8mm	1/4
QTMAD-08L06	L	8mm	3/8
QTMAD-08S04	S	8mm	1/4
QTMAD-08S06	S	8mm	3/8
QTMAD-10L04	L	10mm	1/4
QTMAD-10L06	L	10mm	3/8
QTMAD-10L08	L	10mm	1/2
QTMAD-10S04	S	10mm	1/4
QTMAD-10S06	S	10mm	3/8
QTMAD-10S08	S	10mm	1/2
QTMAD-12L04	L	12mm	1/4
QTMAD-12L06	L	12mm	3/8
QTMAD-12L08	L	12mm	1/2
QTMAD-12L12	L	12mm	3/4
QTMAD-12S04	S	12mm	1/4
QTMAD-12S06	S	12mm	3/8
QTMAD-12S08	S	12mm	1/2
QTMAD-14S08	S	14mm	1/2
QTMAD-15L06	L	15mm	3/8
QTMAD-15L08	L	15mm	1/2
QTMAD-16S06	S	16mm	3/8
QTMAD-16S08	S	16mm	1/2
QTMAD-16S12	S	16mm	3/4
QTMAD-18L08	L	18mm	1/2
QTMAD-18L12	L	18mm	3/4
QTMAD-20S12	S	20mm	1/2
QTMAD-22L12	L	22mm	3/4
QTMAD-25S08	S	25mm	1/2
QTMAD-25S12	S	25mm	3/4
QTMAD-25S16	S	25mm	1
QTMAD-28L16	L	28mm	1
QTMAD-30S20	S	30mm	1 1/4
QTMAD-35L20	L	35mm	1 1/4
QTMAD-38S24	S	38mm	1 1/2
QTMAD-42L24	L	42mm	1 1/2

Metric Tube x BSPT Male

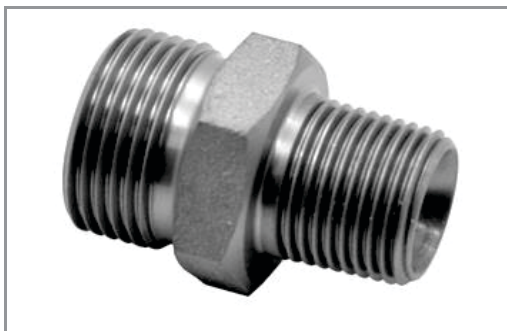

Part Number	DIN	Tube OD	Thread Size
QTMAE-06L02	L	6mm	1/8
QTMAE-06L04	L	6mm	1/4
QTMAE06LL02	LL	6mm	1/8
QTMAE-08L02	L	8mm	1/8
QTMAE-08L04	L	8mm	1/4
QTMAE-10L04	L	10mm	1/4
QTMAE-12L04	L	12mm	1/4
QTMAE-12L06	L	12mm	3/8
QTMAE-12L08	L	12mm	1/2
QTMAE-15L06	L	15mm	3/8
QTMAE-15L08	L	15mm	1/2
QTMAE-18L08	L	18mm	1/2
QTMAE-22L12	L	22mm	3/4
QTMAE-28L16	L	28mm	1
QTMAE-35L20	L	35mm	1 1/4
QTMAE-42L24	L	42mm	1 1/2

JIC Male x Metric Tube



Part Number	DIN	Tube OD	Thread Size
QTMAL06L07	L	6mm	7/16
QTMAL06L09	L	6mm	9/16
QTMAL06S07	S	6mm	7/16
QTMAL06S09	S	6mm	9/16
QTMAL08L09	L	8mm	9/16
QTMAL08S09	S	8mm	9/16
QTMAL10L09	L	10mm	9/16
QTMAL10L12	L	10mm	3/4
QTMAL10S09	S	10mm	9/16
QTMAL10S12	S	10mm	3/4
QTMAL12L12	L	12mm	3/4
QTMAL12S12	S	12mm	3/4
QTMAL14S14	S	14mm	7/8
QTMAL15L14	L	15mm	7/8
QTMAL15L17	L	15mm	1 1/16
QTMAL16S14	S	16mm	7/8
QTMAL16S17	S	16mm	1 1/16
QTMAL18L17	L	18mm	1 1/16
QTMAL20S17	S	20mm	1 1/16
QTMAL22L17	L	22mm	1 1/16
QTMAL28L21	L	28mm	1 5/16
QTMAL30S21	S	30mm	1 5/16
QTMAL30S26	S	30mm	1 5/8
QTMAL35L21	L	35mm	1 5/16
QTMAL35L26	L	35mm	1 5/8
QTMAL38L26	L	38mm	1 5/8

Metric Tube x UNO Male (SAE Oring)



Part Number	DIN	Tube OD	Thread Size
QTMAP-08L07	L	8mm	7/16
QTMAP-08S07	S	8mm	7/16
QTMAP-10L07	L	10mm	7/16
QTMAP-10S09	S	10mm	9/16
QTMAP-12L09	L	12mm	9/16
QTMAP-12L12	L	12mm	3/4
QTMAP-12L14	L	12mm	7/8
QTMAP-12S09	S	12mm	9/16
QTMAP-12S12	S	12mm	3/4
QTMAP-15L12	L	15mm	3/4
QTMAP-15L14	L	15mm	7/8
QTMAP-16S12	S	16mm	3/4
QTMAP-16S14	S	16mm	7/8
QTMAP-18L12	L	18mm	3/4
QTMAP-18L14	L	18mm	7/8
QTMAP-20S12	S	20mm	3/4
QTMAP-20S14	S	20mm	7/8
QTMAP-20S17	S	20mm	1 1/16
QTMAP-22L14	L	22mm	7/8
QTMAP-22L17	L	22mm	1 1/16
QTMAP-22L21	L	22mm	1 5/16
QTMAP-25S17	S	25mm	1 1/16
QTMAP-25S21	S	25mm	1 5/16
QTMAP-28L17	L	28mm	1 1/16
QTMAP-28L21	L	28mm	1 5/16
QTMAP-30S21	S	30mm	1 5/16
QTMAP-30S26	S	30mm	1 5/8
QTMAP-35L21	L	35mm	1 5/16
QTMAP-35L26	L	35mm	1 5/8
QTMAP-38S26	S	38mm	1 5/8
QTMAP-42L26	L	42mm	1 5/8

ADAPTORS (QWF) Weld On Female

BSP Swivel Tubeweld



Part Number	Tube Size	Thread Size	
QWFA04	1/4	1/4	
QWFA06	3/8	3/8	
QWFA08	1/2	1/2	
QWFA0812	1/2	3/4	
QWFA12	3/4	3/4	
QWFA16	1	1	
QWFA20	1 1/4	1 1/4	
QWFA24	1 1/2	1 1/2	

JIC Female Swivel Tubeweld



Part Number	Tube Size	Thread Size	
QWFK0407	1/4	7/16	
QWFK0607	3/8	7/16	
QWFK0609	3/8	9/16	
QWFK0612	3/8	3/4	
QWFK0812	1/2	3/4	
QWFK0814	1/2	7/8	
QWFK1012	5/8	3/4	
QWFK1014	5/8	7/8	
QWFK1017	5/8	1 1/16	
QWFK1214	3/4	7/8	
QWFK1217	3/4	1 1/16	
QWFK1617	1	1 1/16	
QWFK1621	1	1 5/16	
QWFK2021	1 1/4	1 5/16	
QWFK2026	1 1/4	1 5/8	
QWFK2426	1 1/2	1 5/8	
QWFK2430	1 1/2	1 7/8	

UNO Female Port Weld-On



Part Number	Outside Dia	UNO F	
QWFPPF2509	25mm	9/16	
QWFPPF2712	27mm	3/4	
QWFPPF2714	27mm	7/8	
QWFPPF3317	33mm	1 1/16	

ADAPTORS (QWM) Weld On Male

BSPT Male Weld-On



Part Number	Tube Size	Thread Size	
QWME04	1/4	1/4	
QWME06	3/8	3/8	
QWME08	1/2	1/2	
QWME12	3/4	3/4	
QWME16	1	1	
QWME20	1 1/4	1 1/4	
QWME24	1 1/2	1 1/2	

Code 61 Weld-On



Part Number	Tube Size	Flange Size	
QWMF1212	3/4	3/4	
QWMF1216	3/4	1	
QWMF1612	1	3/4	
QWMF1616	1	1	
QWMF1620	1	1 1/4	
QWMF2016	1 1/4	1	
QWMF2020	1 1/4	1 1/4	
QWMF2024	1 1/4	1 1/2	
QWMF2424	1 1/2	1 1/2	
QWMF2432	1 1/2	2	
QWMF3232	2	2	
QWMF3240	2	2 1/2	
QWMF40	2 1/2	2 1/2	

Code 62 Weld-On



Part Number	Tube Size	Flange Size	
QWMG1212	3/4	3/4	
QWMG1216	3/4	1	
QWMG1612	1	3/4	
QWMG1616	1	1	
QWMG1620	1	1 1/4	
QWMG2016	1 1/4	1	
QWMG2020	1 1/4	1 1/4	

JIC Male Weld-On



Part Number	Tube Size	Flange Size	
QWML0407	1/4	7/16	
QWML0609	3/8	9/16	
QWML0612	3/8	3/4	
QWML0809	1/2	9/16	
QWML0812	1/2	3/4	
QWML0814	1/2	7/8	
QWML1012	5/8	3/4	

Continued on the following page

JIC Male Weld-On Continued...



Part Number	Tube Size	Flange Size	
QWML1014	5/8	7/8	
QWML1214	3/4	7/8	
QWML1217	3/4	1 1/16	
QWML1617	1	1 1/16	
QWML1621	1	1 5/16	
QWML2021	1 1/4	1 5/16	
QWML2026	1 1/4	1 5/8	
QWML2426	1 1/2	1 5/8	
QWML2430	1 1/2	1 7/8	

ADAPTORS Bends

Low-pressure 45° Bend

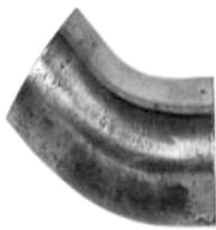

Part Number	Tube Size	SWG	
04-45	1/4	18SWG	<i>Runout</i>
06-45	3/8	16SWG	<i>Runout</i>
08-45	1/2	16 SWG	<i>Runout</i>
12-45	3/4	13SWG	<i>Runout</i>
20-45	1 1/4	11SWG	<i>Runout</i>
24-45	1 1/2	10SWG	<i>Runout</i>
32-45	2	10SWG	<i>Runout</i>

Low-pressure 90° Bend



Part Number	Tube Size	SWG	
04-90	1/4	18SWG	<i>Runout</i>
06-90	3/8	16SWG	<i>Runout</i>
10-90	5/8		<i>Runout</i>
12-90	3/4		<i>Runout</i>
16-90	1		<i>Runout</i>
24-90	1 1/2	10SWG	<i>Runout</i>
32-90	2	10SWG	<i>Runout</i>

High-pressure 45° Bend (6SWG)



Part Number	Tube Size	SWG	
12-45HH	3/4	10SWG	<i>Runout</i>
24-45HH	1 1/2	6SWG	<i>Runout</i>
32-45HH	2	6SWG	<i>Runout</i>

High-pressure 45° Bend (8SWG)



Part Number	Tube Size	SWG	
10-45H	5/8	8SWG	<i>Runout</i>
16-45H	1	8SWG	<i>Runout</i>
20-45H	1 1/4	8SWG	<i>Runout</i>
24-45H	1 1/2	8SWG	<i>Runout</i>
32-45H	2	8SWG	<i>Runout</i>

High-pressure 90° Bend (6SWG)



Part Number	Tube Size	SWG	
24-90HH	1 1/2	6SWG	<i>Runout</i>
32-90HH	2	6SWG	<i>Runout</i>

High-pressure 90° Bend (8SWG)



Part Number	Tube Size	SWG	
20-90H	1 1/4	8SWG	<i>Runout</i>
24-90H	1 1/2	8SWG	<i>Runout</i>
32-90H	2	8SWG	<i>Runout</i>

Stand-pipe 90° Bend



Part Number	Tube Size	SWG	
04-90 SP	1/4	18SWG	<i>Runout</i>
06-90 SP	3/8	16SWG	<i>Runout</i>
08-90 SP	1/2	16SWG	<i>Runout</i>
12-90 SP	3/4	13SWG	<i>Runout</i>
20-90 SP	1 1/4	11SWG	<i>Runout</i>

ADAPTORS Flange Blocks

Code 61 Flange Block - Suit Imperial Pipe



Part Number	Pipe Size	Code 61	Pipe OD
BF1FA-32-O	2	2	2.375" (60.33mm)

Includes O-ring Groove & Clearance Holes

Code 61 Flange Block UNC - Suit Imperial Pipe



Part Number	Pipe Size	Code 61	Pipe OD
BF1FB-32-UNC	2	2	2.375" (60.33mm)

Does Not Include O-ring Groove

Code 61 Flange Block - Suit Imperial Tube



Part Number	Pipe Size	Code 61	Pipe OD
BF2FA-20-O	1 1/4	1 1/4	1 1/4
BF2FA-32-O	2	2	2

Includes O-ring Groove & Clearance Holes

Code 61 Flange Block UNC - Suit Imperial Tube



Part Number	Pipe Size	Code 62	Tube OD
BF2FB-20-UNC	1 1/4	1 1/4	1 1/4
BF2FB-32-UNC	2	2	2

Does Not Include O-ring Groove

Code 61 Flange Block x BSPP Female



Part Number	BSPP F	Code 61	
BF3FA-08-O	1/2	1/2	
BF3FA-12-O	3/4	3/4	
BF3FA-16-O	1	1	
BF3FA-20-O	1 1/4	1 1/4	
BF3FA-24-O	1 1/2	1 1/2	
BF3FA-32-O	2	2	
BF3FA-40-O	2 1/2	2 1/2	
BF3FA-48-O	3	3	

Includes Clearance Holes & O-ring Groove

Code 61 Flange Block



Part Number	BSPP F	Code 61	
BF3FB-08-UNC	1/2	1/2	
BF3FB-12-UNC	3/4	3/4	
BF3FB-16-UNC	1	1	
BF3FB-20-UNC	1 1/4	1 1/4	
BF3FB-24-UNC	1 1/2	1 1/2	
BF3FB-32-UNC	2	2	
BF3FB-40-UNC	2 1/2	2 1/2	
BF3FB-48-UNC	3	3	

Includes UNC Tapped Holes, No O-ring Groove

Code 62 Flange Block x BSPP Female



Part Number	BSPP F	Code 62	
BF3GA-08-O	1/2	1/2	
BF3GA-12-O	3/4	3/4	
BF3GA-16-O	1	1	
BF3GA-20-O	1 1/4	1 1/4	
BF3GA-24-O	1 1/2	1 1/2	
BF3GA-32-O	2	2	

Includes Clearance Holes & O-ring Groove

Code 62 Flange Block



Part Number	UNC F	Code 62	
BF3GB-08-UNC	1/2	1/2	
BF3GB-12-UNC	3/4	3/4	
BF3GB-16-UNC	1	1	
BF3GB-20-UNC	1 1/4	1 1/4	
BF3GB-24-UNC	1 1/2	1 1/2	
BF3GB-32-UNC	2	2	

Includes UNC Tapped Holes, No O-ring Groove

Code 61 x BSPP Female Side Port Adaptor



Part Number	BSPP F	Code 61	
BF4AF-1604	1/4	1	WAS AISFBF1604

ADAPTORS Stainless Steel

Low Pressure 304 BSPP - Pipe Piece



Part Number	BSPP M	Pipe Length	
SSBN20X60	3/4	60mm	Runout
SSBN25X100	1	100mm	Runout
SSBN25X150	1	150mm	Runout
SSBN25X300	1	300mm	Runout
SSBN25X60	1	60mm	Runout

Low Pressure 304 BSPP - Female Elbow 90°



Part Number	BSPP F		
SSE20	3/4		Runout
SSE25	1		Runout

Low Pressure 304 BSPP Male x BSPP Female - 45°



Part Number	BSPP M	BSPP F	
SSEMF2545	1	1	Runout

Low Pressure 304 BSPP Male x BSPP Female - 90°



Part Number	BSPP M	BSPP F	
SSEMF10	3/8	3/8	<i>Runout</i>
SSEMF25	1	1	<i>Runout</i>

Low Pressure 304 BSPP Nipple



Part Number	BSPP M		
SSHN20	3/4	3/4	<i>Runout</i>
SSHN25	1	1	<i>Runout</i>

Low Pressure 304 BSPT Plug



Part Number	BSPP		
SSHP25	1		<i>Runout</i>

Low Pressure 304 BSPP Socket



Part Number	BSPP F		
SSMS25	1		<i>Runout</i>

Low Pressure 304 BSPP Reducing Bush



Part Number	BSPP M	BSPP F	
SSRB20X8	3/4	1/4	<i>Runout</i>
SSRB2520	1	3/4	<i>Runout</i>
SSRB25X8	1	1/4	<i>Runout</i>

Low Pressure 304 BSP Female Tee



Part Number	BSPP		
SST20	3/4		<i>Runout</i>
SST25	1		<i>Runout</i>